

astro

2020/21

**LIGHTING
CATALOGUE**



60cm
Radius

60cm

60cm

60cm

225cm

BATHROOM LIGHTING REGULATIONS

NORMES D'ÉCLAIRAGE DE
SALLE DE BAINS

VORSCHRIFTEN FÜR
BADEZIMMERBELEUCHTUNG

NORMATIVA IN MATERIA DI
ILLUMINAZIONE DA BAGNO

GB ZONE 1

Light fittings in this zone must be a minimum rating of IP44 (or IPX4) spray proof, however Astro Lighting recommends a higher rating of IP65 (or IPX5).

ZONE 2

Light fittings in Zone 2 must be splash-proof. Look for an IP number of IP44 (or IPX4) or higher.

ZONE 3

There are no special requirements in this zone in the United Kingdom. In Ireland, Zone 3 requires IP rated products.

N.B. These regulations apply to domestic applications only, according to IEE Wiring Regulations (17th Edition), BS 7671: 2008. For non-domestic applications, please refer to your electrician.

FR ZONE 1

Les luminaires doivent être protégés contre les projections d'eau: symboles IP45, IP55, IP65. En France, tous les produits utilisés en zone 1 doivent être Très Basse Tension de Sécurité.

ZONE 2

Les armatures doivent, dans cette zone, être protégées contre les projections d'eau: symbole IP44 ou supérieur.

ZONE 3

Aucune exigence particulière n'est requise dans cette zone

NB: Ce résumé est seulement d'application pour un usage domestique. Pour tout autre usage ou, en cas de doute quant au type de luminaire à utiliser, demandez conseil à un électricien qualifié.

DE ZONE 1

Beleuchtungskörper in dieser Zone müssen strahlwassergeschützt sein. Achten Sie auf folgende Zeichen: IP45, IP55 oder IP65.

ZONE 2

Beleuchtungskörper in allen Zonen 2 müssen spritzwassergeschützt sein. Achten Sie auf folgende Zeichen: IP44 oder besser.

ZONE 3

Für diese Zone gelten keine spezifischen Anforderungen für Beleuchtungskörper.

Hinweis: Diese Zusammenfassung ist nur für den Hausgebrauch bestimmt. Für öffentliche Situationen oder in Zweifelsfällen beim Anbringen eines Beleuchtungskörpers wenden Sie sich bitte an einen ausgebildeten Elektriker.

IT ZONE 1

Le installazioni per illuminazione in questo tipo di ambiente devono essere anti-nebulizzazione. È richiesto un grado di protezione IP45 (IPX5) o superiore.



ZONE 2

Le installazioni per illuminazione in zone di tipo 2 devono essere anti-spruzzo. È richiesto un grado di protezione IP44 (IPX4) o superiore.

ZONE 3

Non sono previsti particolari requisiti IP per questo tipo di ambiente.

NB: Tali normative s'intendono applicabili esclusivamente per usi domestici, secondo la normativa britannica IEE Wiring Regulations (17a edizione) BS 7671 2008, in materia di impianti elettrici. Per applicazioni extra domestiche, rivolgersi a un elettricista.

-  ZONE 1 - IP65 (or IPX5)
-  ZONE 2 - IP44 (or IPX4)
-  ZONE 3 - IP20

ALL ZONES:

Any electrical circuits in the bathroom must be protected by a 30mA Residual Current Device (RCD). Electrical equipment exposed to water-jets, e.g. for cleaning purposes, must be at least IP65 (IPX5).

OTTAVINO COLLECTION

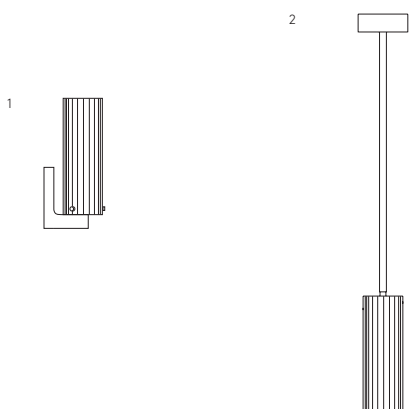

1: OTTAVINO WALL [P. 67](#)

2: OTTAVINO PENDANT [P. 131](#)



ALTEA COLLECTION

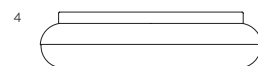

- 1: 360 LED [P. 43](#)
- 2: 500 LED [P. 43](#)
- 3: 150 LED [P. 149](#)
- 4: 300/300 LED [P. 149](#)



MASHIKO COLLECTION

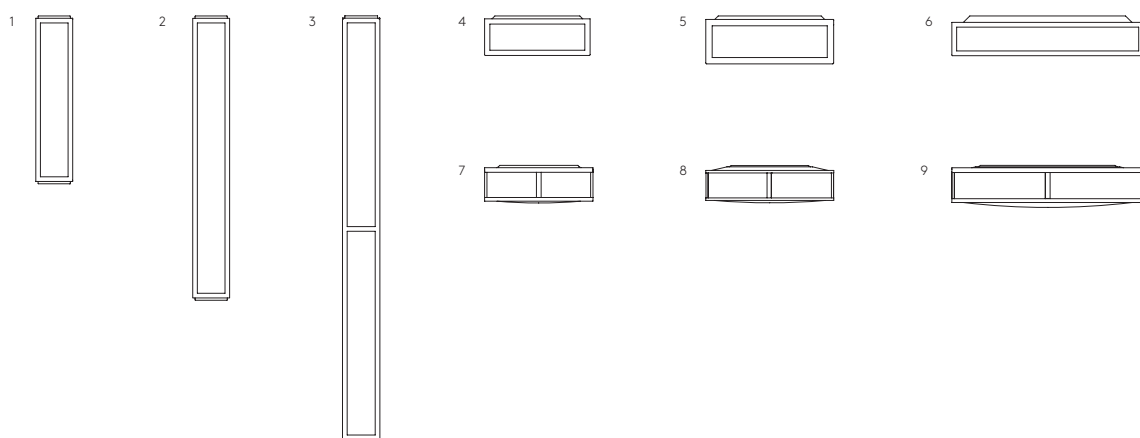

- | | |
|-------------------------------|--------|
| 1: 360/CLASSIC 360 | P. 51 |
| 2: 600 LED | P. 51 |
| 3: 900 LED | P. 51 |
| 4: SQUARE 200 | P. 141 |
| 5: SQUARE CLASSIC 300/300 LED | P. 141 |
| 6: SQUARE 400 | P. 141 |
| 7: ROUND 230 | P. 143 |
| 8: ROUND 300/300 LED | P. 143 |
| 9: ROUND 400 | P. 143 |



KIWI COLLECTION

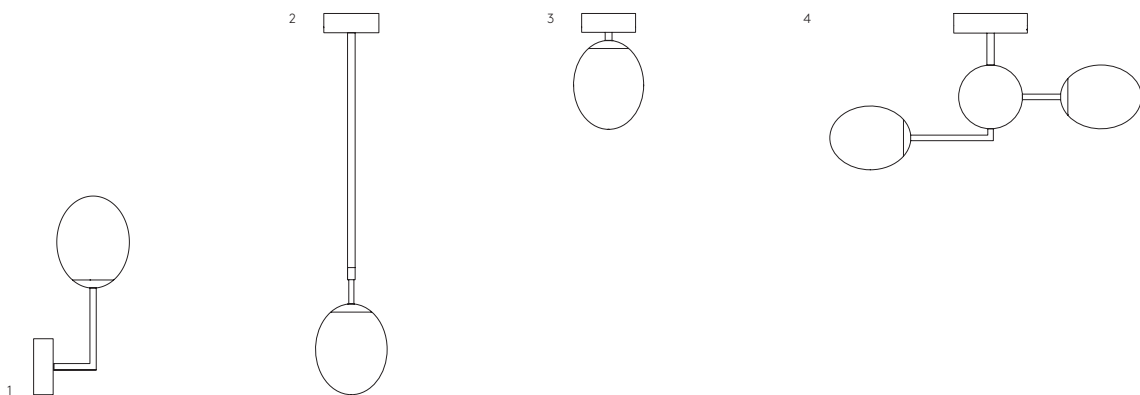

- 1: KIWI WALL P. 73
- 2: KIWI PENDANT P. 135
- 3: KIWI CEILING P. 159
- 4: KIWI THREE P. 139



WALL LIGHTS

APPLIQUES MURALES · WANDLEUCHTEN · LAMPADE DA PARETE



● ARTEMIS
P. 35



● SPARTA
P. 35



● PALERMO
P. 37



● ROMANO
P. 39



● AXIOS
P. 41



● ALTEA
P. 43



● BELGRAVIA
P. 45



● VERSAILLES
P. 47



● BOSTON
P. 49



● MASHIKO
P. 51



● NEW
SALERNO
P. 53



HARVARD WALL
P. 55



HOMEFIELD
P. 57



THURSO
P. 59



CABIN WALL
P. 61



CABARET
P. 63



● NEW
io WALL
P. 65



● NEW
OTTAVINO WALL
P. 67



RIVA 350
P. 69



LAGO 280
P. 71



● KIWI WALL
P. 73



BEAUVILLE
P. 75



ROMA
P. 77



TUBE
P. 78



AREZZO WALL
P. 79



ANTON
P. 81



NENA
P. 81



● CUBE
P. 83



● EPSILON
P. 85



● KAPPA
P. 85



ZEPP0 WALL
P. 87



SAGARA
P. 89



BARI
P. 91



● KARLA
P. 93



TAKETA
P. 95



● KYOTO LED
P. 97



VERONA
P. 97



● DOMINO
P. 98



DAYTON
P. 99



PADOVA ROUND
P. 101



PADOVA SQUARE
P. 101



● DIO
P. 103



● KASHIMA
P. 105



● ZIP
P. 106



SHAVERLIGHT
P. 107



CHIOS
P. 109



● OSLO
P. 111



● ORPHEUS
P. 112



● TERRA 42
P. 113



● TERRA 28
P. 113



● TANGO
P. 114



● NEW
BORGIO 55 / MV
P. 115



● NEW
BORGIO 90 / MV
P. 115

LED

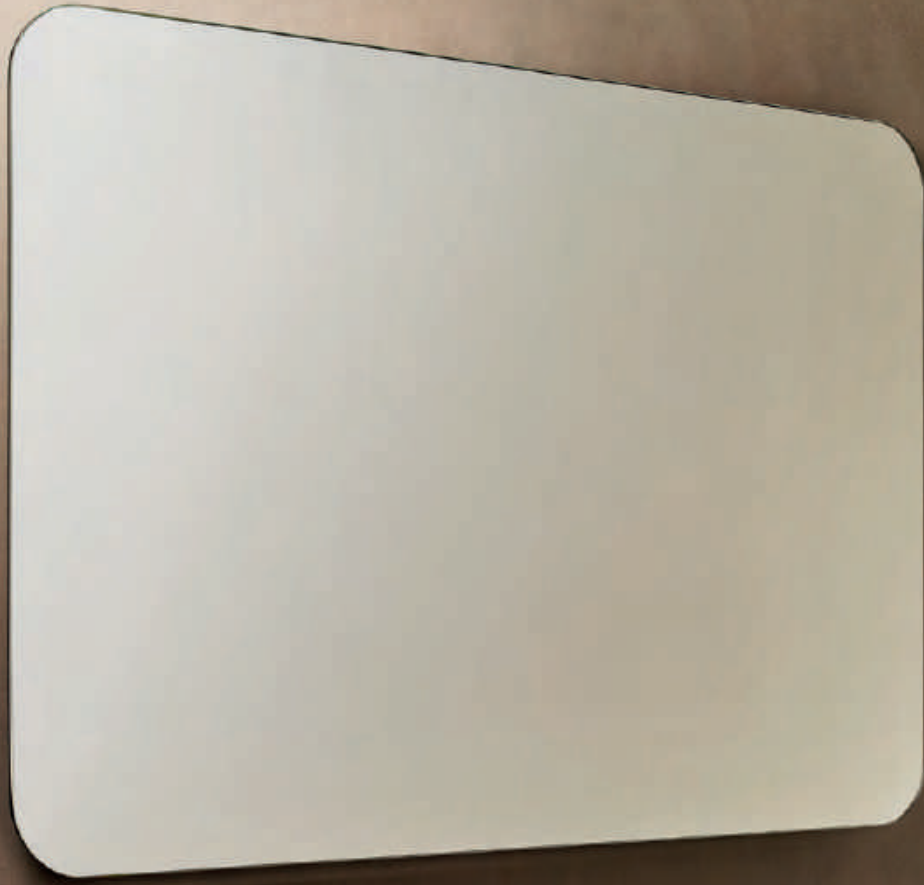



ARTEMIS

SPARTA



ARTEMIS

ZONES 2 3

		LAMP	WATT	INPUT	K	CRI	Lm	IP	CLASS	
600	1308006	Integral LED	12.6W	Mains 230V	3000	80	604	44		✓
900	1308007	Integral LED	17.6W	Mains 230V	3000	80	874	44		✓
1200	1308014	Integral LED	22.7W	Mains 230V	3000	80	1275	44		✓

SPARTA

ZONES 2 3

		LAMP	WATT	INPUT	K	CRI	Lm	IP	CLASS	
600	1322006	Integral LED	11.5W	Mains 230V	3000	80	584	44		✓
900	1322007	Integral LED	17.7W	Mains 230V	3000	80	919	44		✓
1200	1322011	Integral LED	22.7W	Mains 230V	3000	80	1257	44		✓

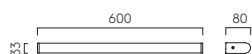

ARTEMIS 600

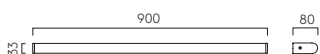

ARTEMIS 900

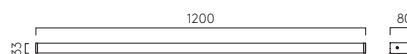

ARTEMIS 1200

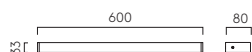

SPARTA 600

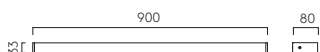

SPARTA 900

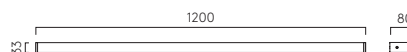

SPARTA 1200

All products on this page can be mirror-mounted (P.117) / Tous les produits sur cette page peuvent être montés sur miroir (P.117) / Diese Produkte sind zur Montage am Spiegel geeignet (P.117) / Tutti i prodotti di questa pagina possono essere fissati ad uno specchio (P.117).

LED



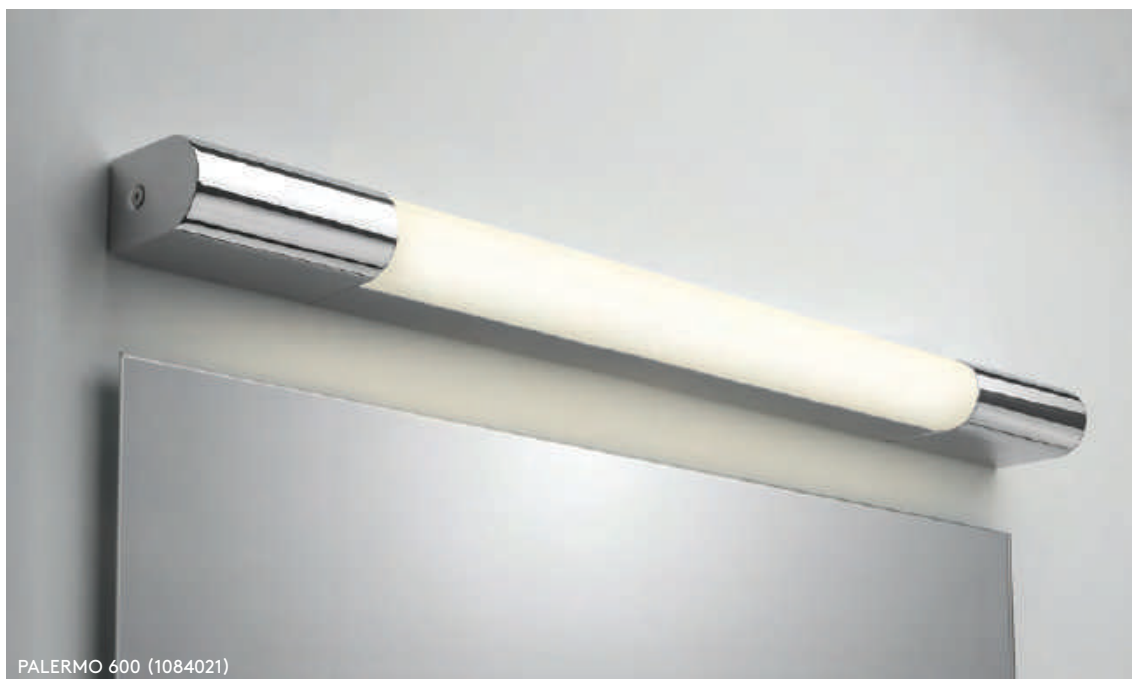

PALERMO 600 (1084021)



PALERMO

ZONES 2 3

	LAMP	WATT	INPUT	K	CRI	Lm	IP	CLASS	
600 1084021	Integral LED	8.1W	Mains 230V	3000	80	364	44		✓
900 1084022	Integral LED	13.6W	Mains 230V	3000	80	650	44		✓
1200 1084023	Integral LED	19.5W	Mains 230V	3000	80	956	44		✓



All products on this page can be mirror-mounted (P.117) / Tous les produits sur cette page peuvent être montés sur miroir (P.117) / Diese Produkte sind zur Montage am Spiegel geeignet (P.117) / Tutti i prodotti di questa pagina possono essere fissati ad uno specchio (P.117).

LED



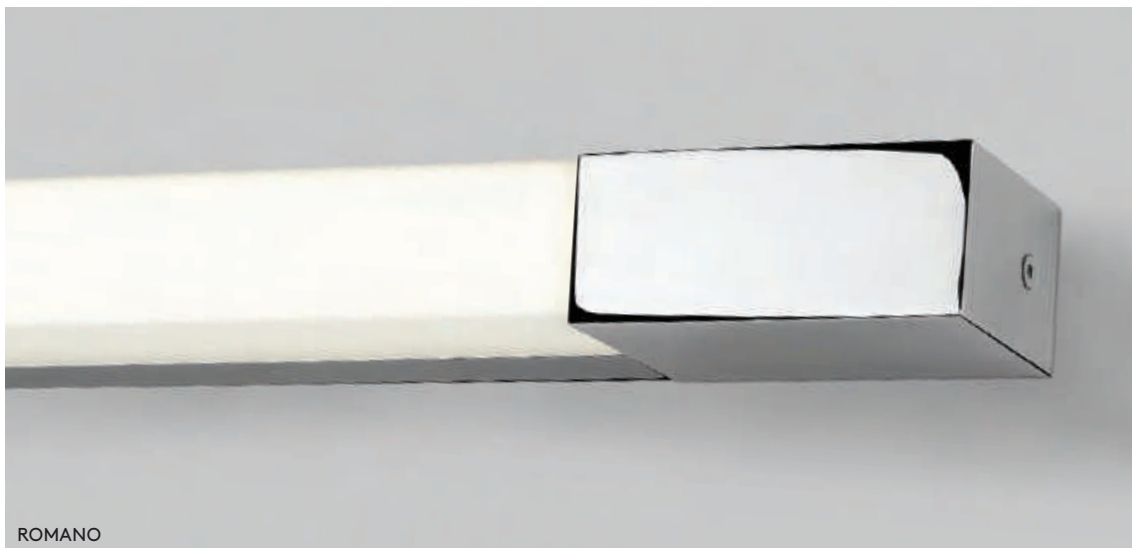

ROMANO



ROMANO

ZONES 2 3

		LAMP	WATT	INPUT	K	CRI	Lm	IP	CLASS	
600	1150015	Integral LED	8.3W	Mains 230V	3000	80	399	44		✓
900	1150016	Integral LED	13.8W	Mains 230V	3000	80	686	44		✓
1200	1150017	Integral LED	19.6W	Mains 230V	3000	80	1028	44		✓

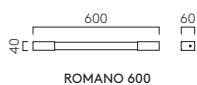

All products on this page can be mirror-mounted (P.117) / Tous les produits sur cette page peuvent être montés sur miroir (P.117) / Diese Produkte sind zur Montage am Spiegel geeignet (P.117) / Tutti i prodotti di questa pagina possono essere fissati ad uno specchio (P.117).





AXIOS 600 (1307007)



AXIOS

ZONES 2 3

		LAMP	WATT	INPUT	K	CRI	Lm	IP	CLASS	
300	1307009	Integral LED	5.9W	Mains 230V	3000	80	205	44		✓
600	1307007	Integral LED	12.8W	Mains 230V	3000	80	436	44		✓
900	1307008	Integral LED	17.8W	Mains 230V	3000	80	676	44		✓
1200	1307014	Integral LED	22.7W	Mains 230V	3000	80	1282	44		✓

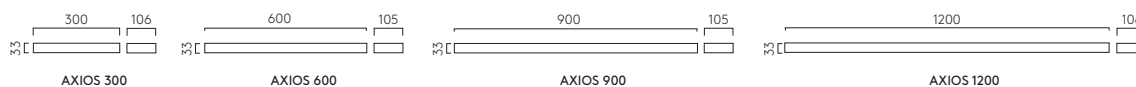

All products on this page can be mirror-mounted (P.117) / Tous les produits sur cette page peuvent être montés sur miroir (P.117) / Diese Produkte sind zur Montage am Spiegel geeignet (P.117) / Tutti i prodotti di questa pagina possono essere fissati ad uno specchio (P.117).

LED





ALTEA 150 LED (1133004)



ALTEA 360 LED (1133005)



ALTEA

ZONES 2 3

	LAMP	WATT	INPUT	K	CRI	Lm	IP	CLASS		
150 LED	1133004	Integral LED	7.7W	Mains 230V	2700	80	346	44		✓
360 LED	1133005	Integral LED	15.6W	Mains 230V	3000	80	650	44		✓
500 LED	1133006	Integral LED	20.3W	Mains 230V	3000	80	858	44		✓

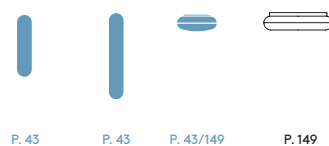
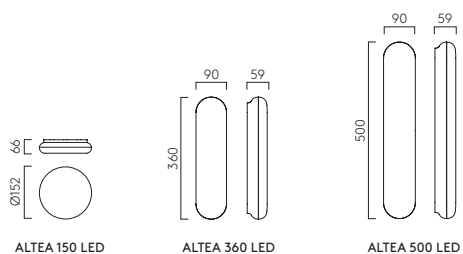

LED





BELGRAVIA 400 (1110007)

BELGRAVIA 600 (1110010)



BELGRAVIA

ZONES 2 3

				LAMP	WATT	INPUT	K	CRI	Lm	IP	CLASS	
400	1110007	1110009		Integral LED	11.5W	Mains 230V	3000	80	410	44		✓
500	1110004			Integral LED	15.6W	Mains 230V	3000	80	877	44		✓
600	1110008	1110010		Integral LED	19W	Mains 230V	3000	80	723	44		✓

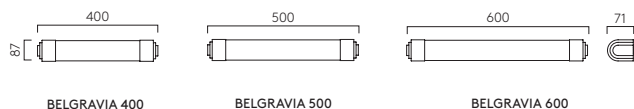

All products on this page can be mirror-mounted (P.117)
 / Tous les produits sur cette page peuvent être montés sur
 miroir (P.117) / Diese Produkte sind zur Montage am Spiegel
 geeignet (P.117) / Tutti i prodotti di questa pagina possono
 essere fissati ad uno specchio (P.117).

LED





VERSAILLES 250 (1380015)



VERSAILLES 370 (1380013)

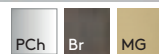

VERSAILLES

ZONES 2 3

	PCh	1380001	Br	1380004	MG	1380015	LAMP	WATT	INPUT	K	CRI	Lm	IP	CLASS	ⓧ	🌐
250	PCh	1380001	Br	1380004	MG	1380015	Integral LED	4.7W	Mains 230V	3000	80	371	44	□	✓	✓
370	PCh	1380013	Br	1380014			Integral LED	15.1W	Mains 230V	3000	80	609	44	□	✓	✓
400	PCh	1380002	Br	1380003	MG	1380016	Integral LED	7.2W	Mains 230V	3000	80	650	44	□	✓	✓
600	PCh	1380011	Br	1380012			Integral LED	25W	Mains 230V	3000	80	1078	44	□	✓	✓

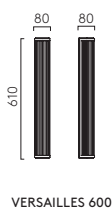
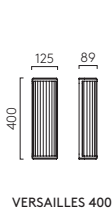
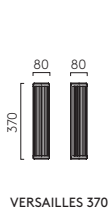
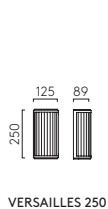

All products on this page can be mirror-mounted (P.117) / Tous les produits sur cette page peuvent être montés sur miroir (P.117) / Diese Produkte sind zur Montage am Spiegel geeignet (P.117) / Tutti i prodotti di questa pagina possono essere fissati ad uno specchio (P.117).

LED





BOSTON 370 (1370002)

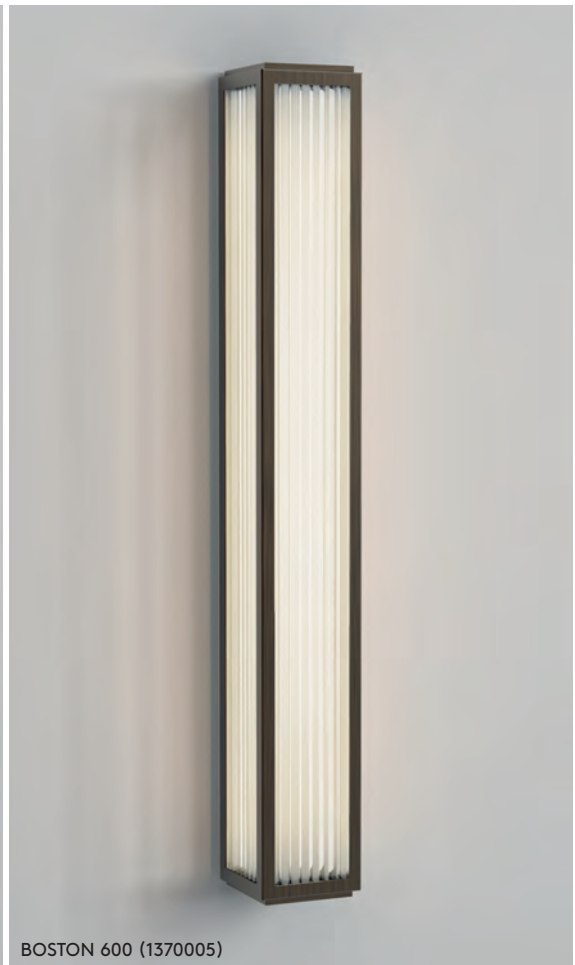

BOSTON 600 (1370005)



BOSTON

ZONES 2 3

	LAMP	WATT	INPUT	K	CRI	Lm	IP	CLASS	☑	☑	
370	PCh 1370002	Br 1370004	Integral LED	13.9W	Mains 230V	3000	80	465	44	☑	☑
600	PCh 1370003	Br 1370005	Integral LED	21.9W	Mains 230V	3000	80	811	44	☑	☑

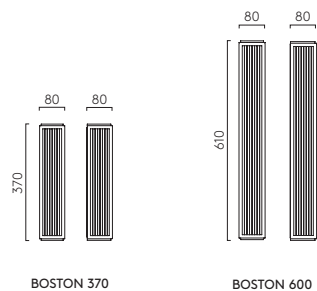

BOSTON 370

BOSTON 600

All products on this page can be mirror-mounted (P.117) / Tous les produits sur cette page peuvent être montés sur miroir (P.117) / Diese Produkte sind zur Montage am Spiegel geeignet (P.117) / Tutti i prodotti di questa pagina possono essere fissati ad uno specchio (P.117).

LED



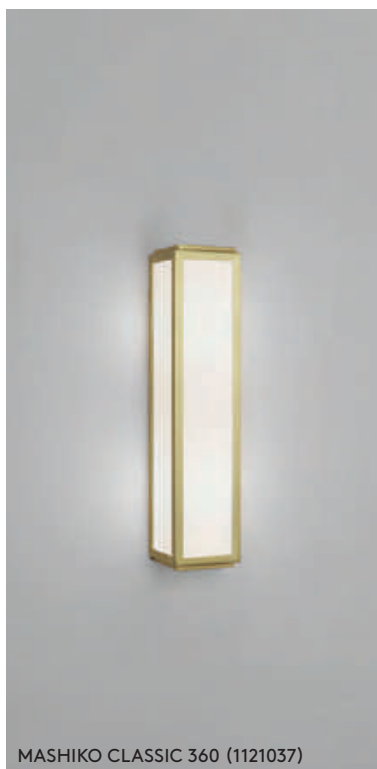

MASHIKO CLASSIC 360 (1121037)



MASHIKO 600 LED (1121058)

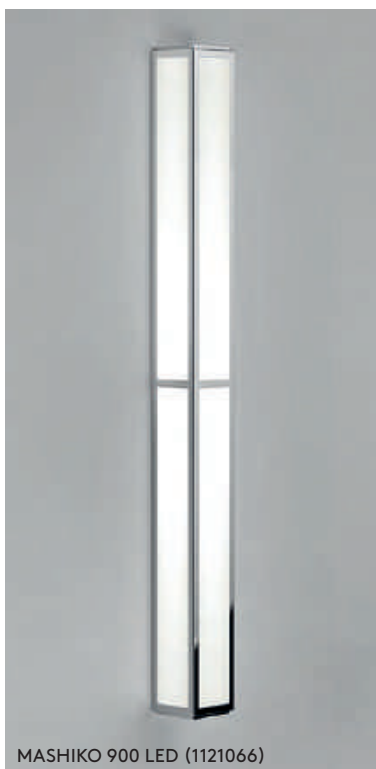

MASHIKO 900 LED (1121066)

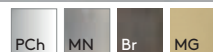

MASHIKO

ZONES 2 3

	LAMP	WATT	INPUT	K	CRI	Lm	IP	CLASS						
CLASSIC 360														
	PCh 1121006	Br 1121055	MG 1121037	E14 LED	7W max	-	-	-	-	44		✓	✓	-
360 LED	PCh 1121018	Br 1121060	MN 1121065	Integral LED	7.8W	Mains 230V	3000	80	525	44		-	-	✓
600 LED	PCh 1121020	Br 1121058		Integral LED	10.6W	Mains 230V	3000	80	658	44		-	-	✓
900 LED	PCh 1121066			Integral LED	33.8W	Mains 230V	2700	80	1458	44		-	-	✓

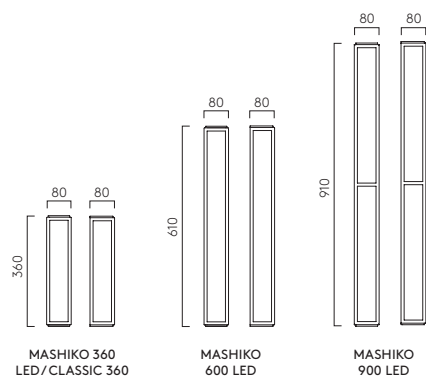

All products on this page can be mirror-mounted (P.117) / Tous les produits sur cette page peuvent être montés sur miroir (P.117) / Diese Produkte sind zur Montage am Spiegel geeignet (P.117) / Tutti i prodotti di questa pagina possono essere fissati ad uno specchio (P.117).

▼ Lamp excluded, see page 714 / La lampe exclu, voir page 714 / La lampadina esclusi a pagina 714 / Das Leuchtmittel ist ausgeschlossen, sie auf Seite 714.

LED





SALERNO LED (1178003)



SALERNO (1178006)



SALERNO 520 (1178007)



SALERNO

ZONES 2 3

			LAMP	WATT	INPUT	K	CRI	Lm	IP	CLASS					
NEW	TB	1178001	NB	1178006	E14 LED ▼	2 x 7W max	Mains 230V	-	-	-	44		✓	✓	-
LED	TB	1178002	PN	1178003	Integral LED	8.1W	Mains 230V	3000	80	448	44		-	✓	✓
NEW	520	TB	1178007	E14 LED ▼	3 x 5W	Mains 230V	-	-	-	44		✓	✓	-	
NEW	520 LED	TB	1178008	Integral LED	15.4W	Mains 230V	3000	80	916	44		✓	✓	✓	

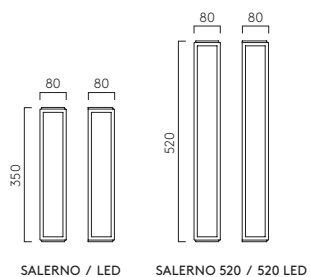

▼ Lamp excluded, see page 714/ La lampe exclu, voir page 714/ La lampadina esclusi a pagina 714/ Das Leuchtmittel ist ausgeschlossen, sie auf Seite 714.

LED

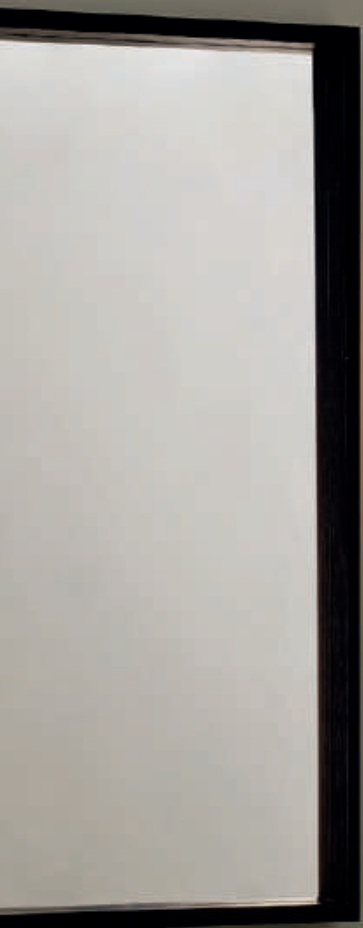



HARVARD WALL (1402007)

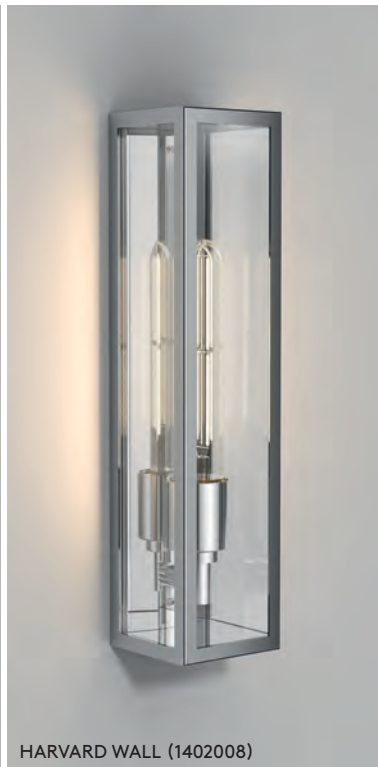

HARVARD WALL (1402008)



HARVARD WALL (1402009)



HARVARD WALL

ZONES 2 3

	LAMP	WATT	CLASS	IP		
PSS 1402008 Br 1402009 MB 1402010 NB 1402007	E27 LED▼	4W max		44	✓	✓

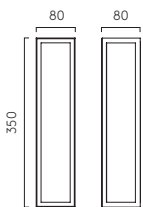

HARVARD WALL

▼ Lamp excluded, see page 714 / La lampe exclu, voir page 714 / La lampadina esclusi a pagina 714 / Das Leuchtmittel ist ausgeschlossen, sie auf Seite 714.





HOMEFIELD 160 (1095012)



HOMEFIELD 160 (1095003)



FROSTED GLASS ACCESSORY
6030002



HOMEFIELD

ZONES 2 3

	MB	PN	Br	MW	LAMP	WATT	IP	CLASS	☾	Ⓢ
160	1095001	1095003	1095029	1095012	E27 LED ▼	12W max	44	⊕	✓	✓
COASTAL	1095034				E27 LED ▼	12W max	44	⊕	✓	✓

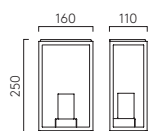

HOMEFIELD 160

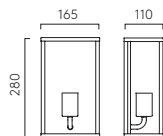

HOMEFIELD COASTAL

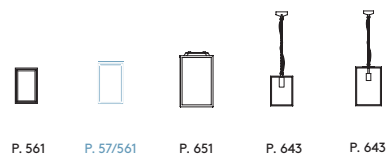

P. 561 P. 57/561 P. 651 P. 643 P. 643

▼ Lamp excluded, see page 714 / La lampe exclu, voir page 714 / La lampadina esclusi a pagina 714 / Das Leuchtmittel ist ausgeschlossen, sie auf Seite 714.





THURSO OVAL (1376004)



THURSO OVAL (1376002)



THURSO OVAL

ZONES **2 3**

PN 1376004

NB 1376002

LAMP	WATT	IP	CLASS		
E27 LED ▼	12W max	44		✓	✓

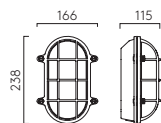

THURSO OVAL

▼ Lamp excluded, see page 714 / La lampe exclu, voir page 714 / La lampadina esclusi a pagina 714 / Das Leuchtmittel ist ausgeschlossen, sie auf Seite 714.





CABIN WALL (1368004)



CABIN WALL (1368025)



CABIN WALL

ZONES 2 3

	Br	AB	PN	LAMP	WATT	IP	CLASS	☾	Ⓢ
	1368025	1368003	1368004	E27 LED ▼	12W max	44	⊕	✓	✓
FROSTED	1368026	1368008	1368006	E27 LED ▼	12W max	44	⊕	✓	✓

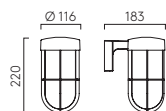

CABIN WALL



▼ Lamp excluded, see page 714 / La lampe exclu, voir page 714 / La lampadina esclusi a pagina 714 / Das Leuchtmittel ist ausgeschlossen, sie auf Seite 714.





CABARET FIVE (1087003)

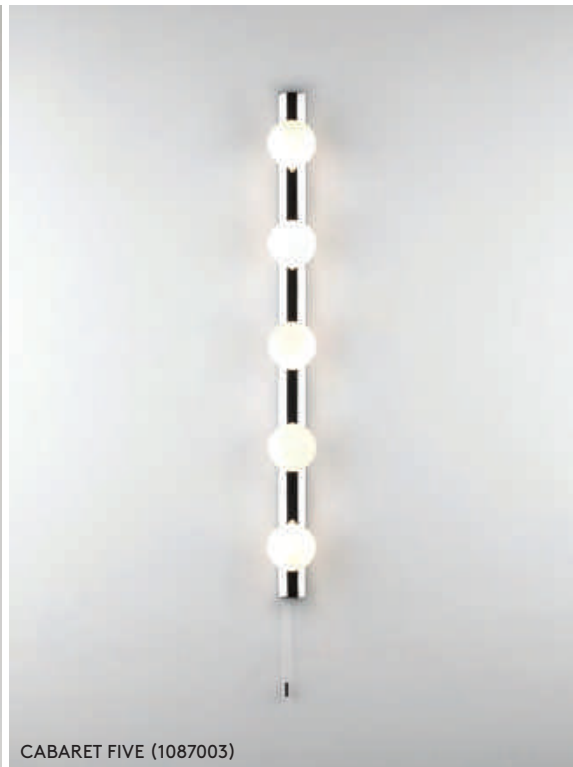

CABARET FIVE (1087003)



CABARET

ZONES

	LAMP	WATT	IP	CLASS			
FOUR 1087002	G9 LED ▼	4 x 3W max	44		✓	✓	✓
FIVE 1087003	G9 LED ▼	5 x 3W max	44		✓	✓	✓

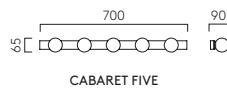
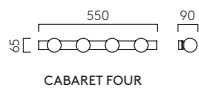

Removable pull-cord switch/Tirette amovible/Zugschalter entfernbar / Interruttore con filo a tirante rimovibile.

▼ Lamp excluded, see page 714 / La lampe exclu, voir page 714 / La lampadina esclusi a pagina 714 / Das Leuchtmittel ist ausgeschlossen, sie auf Seite 714.

LED



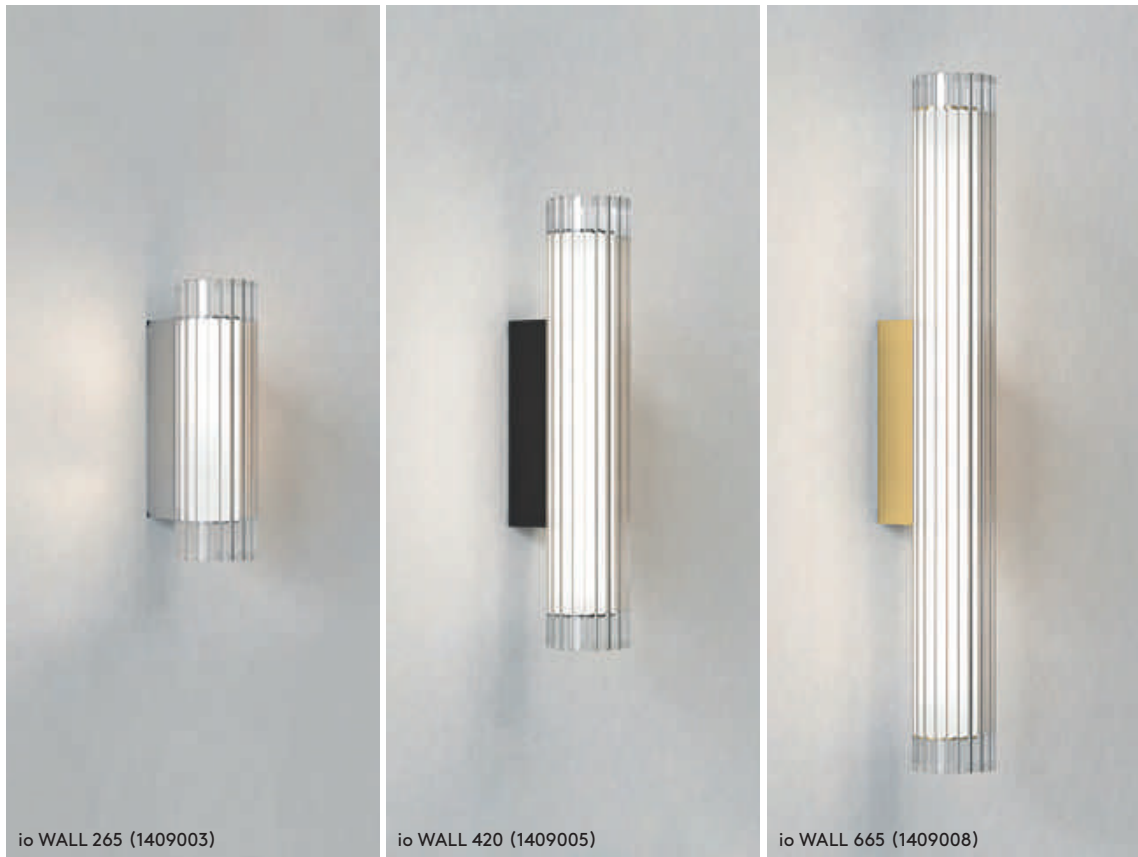

io WALL 265 (1409003)

io WALL 420 (1409005)

io WALL 665 (1409008)



NEW io WALL

ZONES 2 3

	LAMP	WATT	INPUT	K	CRI	Lm	CLASS			
265 PCh 1409003	Integral LED	4.9W	Mains 230V	3000	80	403		✓	✓	✓
420 PCh 1409001 MB 1409005 MG 1409006	Integral LED	6.5W	Mains 230V	3000	80	605		✓	✓	✓
665 PCh 1409002 MB 1409007 MG 1409008	Integral LED	8.2W	Mains 230V	3000	80	825		✓	✓	✓

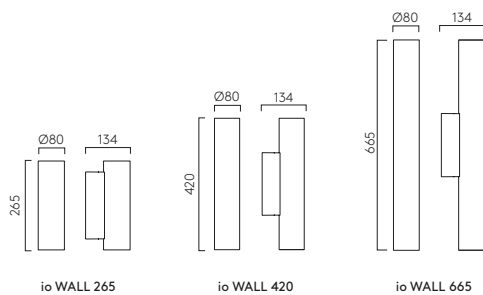





OTTAVINO WALL (1411001)



OTTAVINO WALL (1411001)

PCh

NEW

OTTAVINO WALL

ZONES 2 3

PCh 1411001

LAMP	WATT	IP	CLASS		
E14 LED ▼	5W max	44		✓	✓

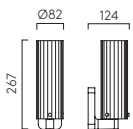

OTTAVINO WALL

▼ Lamp excluded, see page 714/ La lampe exclu, voir page 714/ La lampadina esclusi a pagina 714/ Das Leuchtmittel ist ausgeschlossen, sie auf Seite 714.





RIVA 350 (1214008 + 5018015)



RIVA 350 (1214004 + 5018004)



RIVA 350 (1214001 + 5018007)

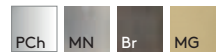

RIVA 350

ZONES 2 3 SHADE EXCLUDED

PCh 1214001 MN 1214004 Br 1214010 MG 1214008

LAMP E27 LED[▼] WATT 12W max IP 44 CLASS

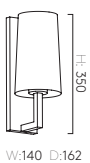

CONE 240

- WG 5018007
- WF 5018004
- BF 5018015
- OF -
- PF 5018014

P. 687: Special Shade Colours / Couleurs spéciales / Sonderfarben / Colori speciali

▼ Lamp excluded, see page 714 / La lampe exclu, voir page 714 / La lampadina esclusi a pagina 714 / Das Leuchtmittel ist ausgeschlossen, sie auf Seite 714.





LAGO 280 (1297002 + 5018001)



LAGO 280 (1297007 + 5019001)



LAGO 280

ZONES **2 3** SHADE EXCLUDED

	LAMP	WATT	IP	CLASS		
PCh 1297001	E27 LED ▼	12W max	44		✓	✓
MN 1297002						
Br 1297007						

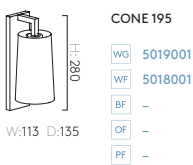

P. 687: Special Shade Colours / Couleurs spéciales / Sonderfarben / Colori speciali

▼ Lamp excluded, see page 714 / La lampe exclu, voir page 714 / La lampadina esclusi a pagina 714 / Das Leuchtmittel ist ausgeschlossen, sie auf Seite 714.

LED





KIWI WALL (1390003)



KIWI WALL (1390003)



KIWI WALL

ZONES 2 3

	LAMP	WATT	INPUT	K	CRI	Lm	IP	CLASS	Ⓢ
PCh 1390003 PCo 1390001	Integral LED	7.2W	Mains 230V	2700	80	567	44	Ⓢ	✓

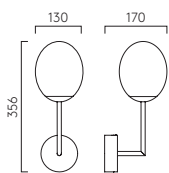

KIWI WALL



P. 73



P. 159

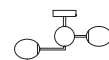

P. 139



P. 135





BEAUVILLE (1388003 + 5033005)



BEAUVILLE (1388001 + 5033005)

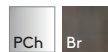

BEAUVILLE

ZONES **2 3** SHADE EXCLUDED

	LAMP	WATT	IP	CLASS	
PCh 1388001 Br 1388003	E27 LED*	12W max	44		<input checked="" type="checkbox"/>

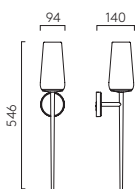

BEAUVILLE GLASS

wg 5033005

BEAUVILLE

▼ Lamp excluded, see page 714 / La lampe exclu, voir page 714 / La lampadina esclusi a pagina 714 / Das Leuchtmittel ist ausgeschlossen, sie auf Seite 714.



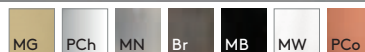

ROMA

ZONES 2 3

	LAMP	WATT	IP	CLASS																											
<table border="0"> <tr> <td> 1050001</td> <td> 1050005</td> <td> 1050006</td> <td></td> <td></td> <td></td> <td></td> <td></td> </tr> <tr> <td> 1050007</td> <td> 1050008</td> <td> 1050010</td> <td></td> <td></td> <td></td> <td></td> <td></td> </tr> <tr> <td> 1050009</td> <td></td> <td></td> <td></td> <td></td> <td></td> <td></td> <td></td> </tr> </table>	1050001	1050005	1050006						1050007	1050008	1050010						1050009								G9 LED▼	3W max	44		✓	-	✓
1050001	1050005	1050006																													
1050007	1050008	1050010																													
1050009																															
SWITCHED 1050002	G9 LED▼	3W max	44		✓	✓	✓																								

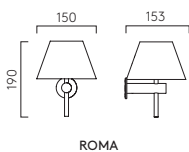

ROMA

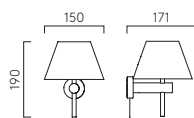

ROMA SWITCHED

All products on this page can be mirror-mounted, Excl. 1050002 (P.117) / Tous les produits sur cette page peuvent être montés sur miroir, excl. 1050002 (P.117) / Diese Produkte sind zur Montage am Spiegel geeignet, excl. 1050002 (P.117) / Tutti i prodotti di questa pagina possono essere fissati ad uno specchio, excl. 1050002 (P.117).

ROMA SWITCHED - Removable pull-cord switch / Tirette amovibile / Zugschalter entfernbar / Interruttore con filo a tirante rimovibile.

▼ Lamp excluded, see page 714 / La lampe exclu, voir page 714 / La lampadina esclusi a pagina 714 / Das Leuchtmittel ist ausgeschlossen, sie auf Seite 714.

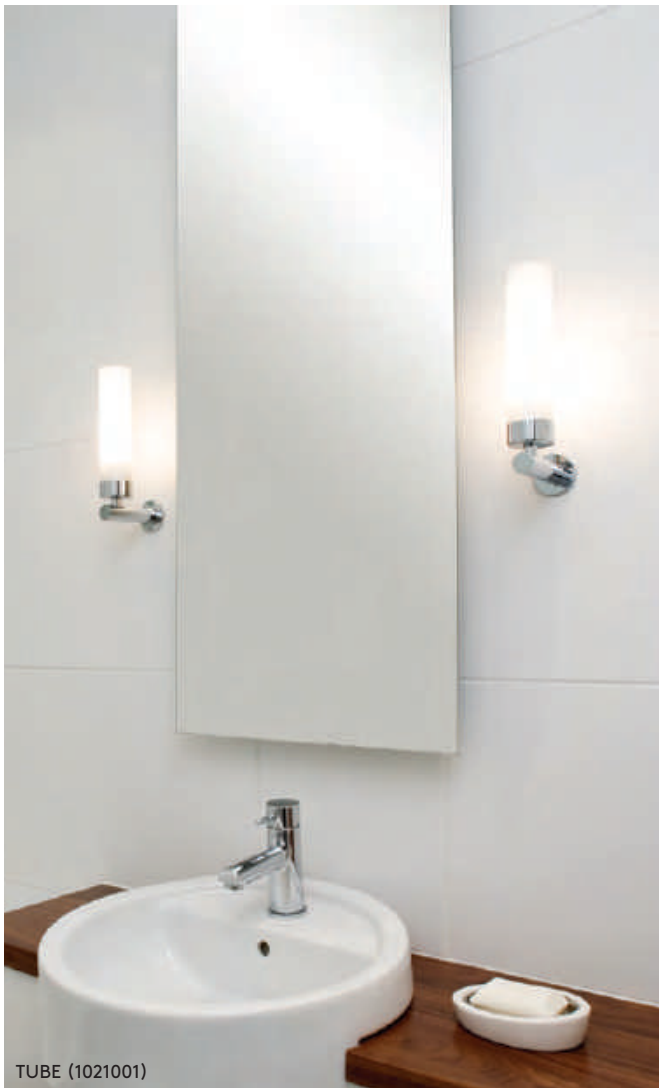

TUBE (1021001)



TUBE (1021001)

PCh

TUBE

ZONES 2 3

	LAMP	WATT	IP	CLASS		
1021001	E14 LED▼	7W max	44		✓	✓

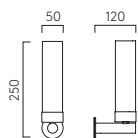

TUBE

All products on this page can be mirror-mounted (P.117)
 / Tous les produits sur cette page peuvent être montés sur
 miroir (P.117) / Diese Produkte sind zur Montage am Spiegel
 geeignet (P.117) / Tutti i prodotti di questa pagina possono
 essere fissati ad uno specchio (P.117).

▼ Lamp excluded, see page 714 / La lampe exclu, voir page 714
 / La lampadina esclusi a pagina 714 / Das Leuchtmittel ist
 ausgeschlossen, sie auf Seite 714.



AREZZO WALL (1049001)

PCh

AREZZO WALL

ZONES 2 3

	LAMP	WATT	IP	CLASS		
PCh 1049001	G9 LED▼	3W max	44		✓	✓

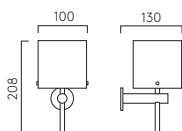

AREZZO

All products on this page can be mirror-mounted (P.117) / Tous les produits sur cette page peuvent être montés sur miroir (P.117) / Diese Produkte sind zur Montage am Spiegel geeignet (P.117) / Tutti i prodotti di questa pagina possono essere fissati ad uno specchio (P.117).

▼ Lamp excluded, see page 714 / La lampe exclu, voir page 714 / La lampadina esclusi a pagina 714 / Das Leuchtmittel ist ausgeschlossen, sie auf Seite 714.





ANTON (1106001)



NENA (1105001)

PCh

ANTON

ZONES 2 3

	LAMP	WATT	IP	CLASS		
PCh 1106001	E14 LED▼	7W max	44		✓	✓

NENA

ZONES 2 3

	LAMP	WATT	IP	CLASS		
PCh 1105001	G9 LED▼	3W max	44		✓	✓

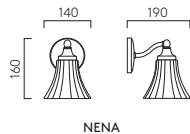
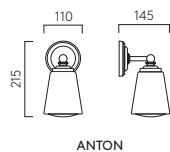

▼ Lamp excluded, see page 714/La lampe exclu, voir page 714/La lampadina esclusi a pagina 714/Das Leuchtmittel ist ausgeschlossen, sie auf Seite 714.

LED





CUBE (1140001)



CUBE

ZONES 2 3

	LAMP	WATT	INPUT	K	CRI	Lm	IP	CLASS	Ⓢ
LED									
1140002	Integral LED	5.9W	Mains 230V	3000	80	345	44		✓
1140001	G9 LED▼	3W max	-	-	-	-	44		✓

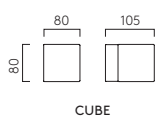
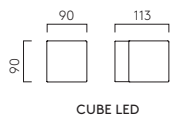

▼ Lamp excluded, see page 714 / La lampe exclu, voir page 714 / La lampadina esclusi a pagina 714 / Das Leuchtmittel ist ausgeschlossen, sie auf Seite 714.

LED





EPSILON (1124004)



KAPPA (1151003)



EPSILON

ZONES 2 3

	LAMP	WATT	INPUT	K	CRI	Lm	IP	CLASS	
1124004	Integral LED	3.3W	Mains 230V	3000	90	103	44		✓

KAPPA

ZONES 2 3

	LAMP	WATT	INPUT	K	CRI	Lm	IP	CLASS	
1151003	Integral LED	3.1W	Mains 230V	3000	90	113	44		✓



EPSILON



KAPPA





ZEPP0 WALL (1176004)

PCh

ZEPP0 WALL

ZONES 2 3

	LAMP	WATT	IP	CLASS		
PCh 1176004	G9 LED▼	3W max	44		✓	✓

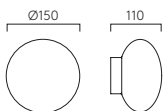

ZEPP0

▼ Lamp excluded, see page 714 / La lampe exclu, voir page 714 / La lampadina esclusi a pagina 714 / Das Leuchtmittel ist ausgeschlossen, sie auf Seite 714.





SAGARA (1168001)



SAGARA

ZONES **2 3**

	LAMP	WATT	IP	CLASS		
PCh 1168001	G9 LED ▼	3W max	44		✓	✓

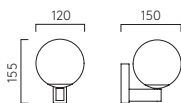

SAGARA

▼ Lamp excluded, see page 714 / La lampe exclu, voir page 714 / La lampadina esclusi a pagina 714 / Das Leuchtmittel ist ausgeschlossen, sie auf Seite 714.





BARI

ZONES 2 3

	LAMP	WATT	IP	CLASS		
PCh 1047001 MN 1047004 Br 1047005 MG 1047008	G9 LED	3W max	44		✓	✓
MB 1047006 MW 1047007 PCo 1047009						

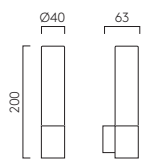

BARI

▼ Lamp excluded, see page 714 / La lampe exclu, voir page 714 / La lampadina esclusi a pagina 714 / Das Leuchtmittel ist ausgeschlossen, sie auf Seite 714.

LED





KARLA (1321001)

PCh

KARLA

ZONES 2 3

	LAMP	WATT	INPUT	K	CRI	Lm	IP	CLASS	
PCh 1321001	Integral LED	4.2W	Mains 230V	3000	80	280	44		✓

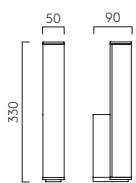

KARLA





TAKETA (1169001)



TAKETA

ZONES 2 3

	LAMP	WATT	IP	CLASS		
1169001	E14 LED▼	7W max	44		✓	✓

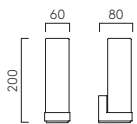

TAKETA

▼ Lamp excluded, see page 714 / La lampe exclu, voir page 714 / La lampadina esclusi a pagina 714 / Das Leuchtmittel ist ausgeschlossen, sie auf Seite 714.

LED





KYOTO (1060006)



VERONA (1147001)



KYOTO

ZONES 2 3

	LAMP	WATT	INPUT	K	CRI	Lm	IP	CLASS		
1060006	Integral LED	8.8W	Mains 230V	2700	80	357	44		-	✓

VERONA

ZONES 2 3

	LAMP	WATT	IP	CLASS		
1147001	E14 LED▼	7W max	44		✓	✓

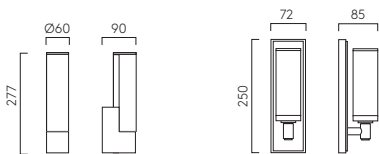

KYOTO LED

VERONA

▼ Lamp excluded, see page 714 / La lampe exclu, voir page 714 / La lampadina esclusi a pagina 714 / Das Leuchtmittel ist ausgeschlossen, sie auf Seite 714.



DOMINO (1355001)



DOMINO (1355001)

PCh

DOMINO

ZONES 2 3

	LAMP	WATT	INPUT	K	CRI	Lm	IP	CLASS	
PCh 1355001	Integral LED	5W	Mains 230V	3000	80	283	44	□	✓

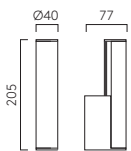

DOMINO



DAYTON (1044001) ROUGH LUXE HOTEL (PHOTOGRAPHER: MARCUS PEEL)



DAYTON

ZONES **2 3**

	LAMP	WATT	IP	CLASS		
PCh 1044001	G9 LED▼	2 x 3W max	44		✓	✓

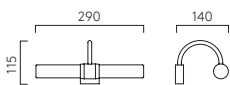

DAYTON

▼ Lamp excluded, see page 714 / La lampe exclu, voir page 714 / La lampadina esclusi a pagina 714 / Das Leuchtmittel ist ausgeschlossen, sie auf Seite 714.

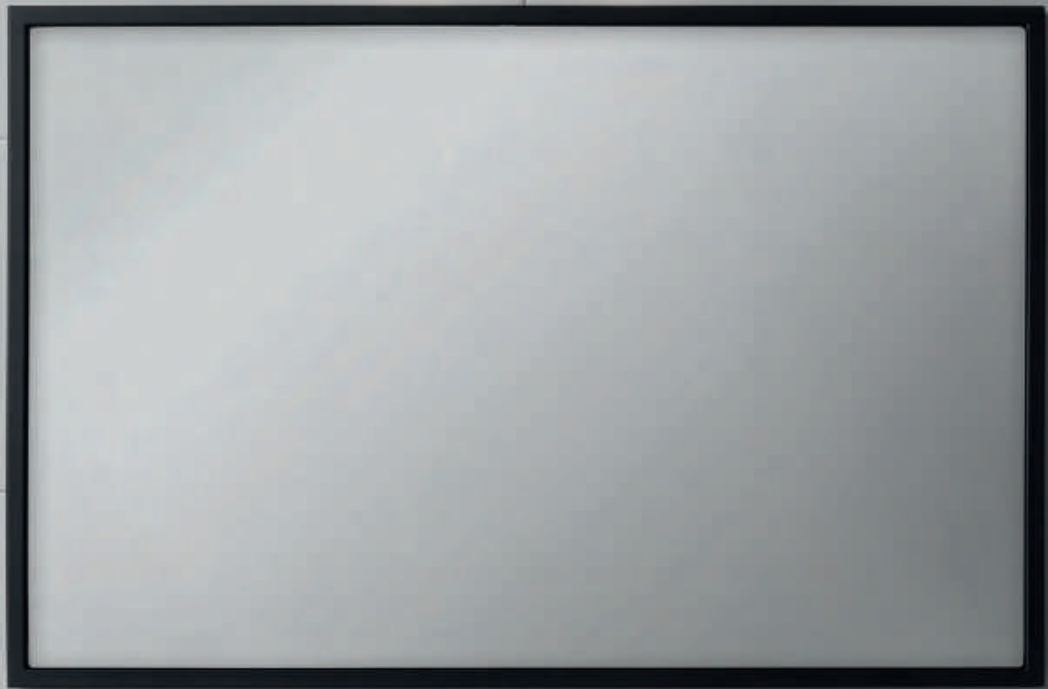



PADOVA SQUARE (1143004)



PADOVA

ZONES 2 3

	LAMP	WATT	IP	CLASS		
ROUND 1143001	G9 LED ▼	2 x 3W max	44		✓	✓
SQUARE 1143004	G9 LED ▼	2 x 3W max	44		✓	✓

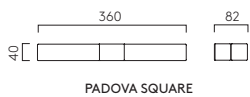
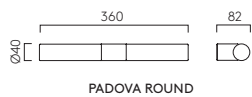

▼ Lamp excluded, see page 714 / La lampe exclu, voir page 714 / La lampadina esclusi a pagina 714 / Das Leuchtmittel ist ausgeschlossen, sie auf Seite 714.

LED





DIO (1305006)

PCh

DIO

ZONES 2 3

	LAMP	WATT	INPUT	K	CRI	Lm	IP	CLASS	
PCh 1305006	Integral LED	6.4W	Mains 230V	3000	80	320	44	□	✓

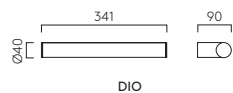

LED

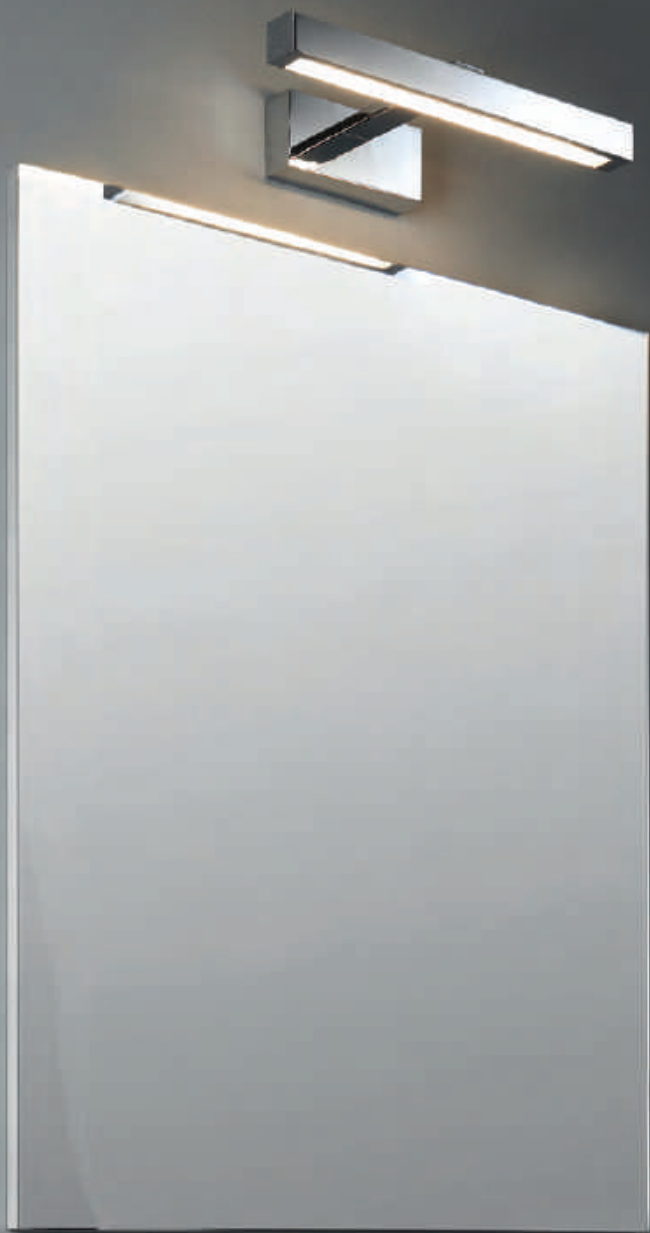



KASHIMA 620 (1174004)



KASHIMA

ZONES **2 3**

		LAMP	WATT	INPUT	K	CRI	Lm	IP	CLASS	
350	1174003	Integral LED	4.5W	Mains 230V	3000	80	165	44		✓
620	1174004	Integral LED	8.2W	Mains 230V	3000	80	387	44		✓

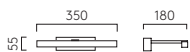

KASHIMA 350 LED

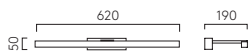

KASHIMA 620 LED



ZIP (1289001)



PCh

ZIP

ZONES 2 3

	LAMP	WATT	INPUT	K	CRI	Lm	IP	CLASS	
PCh 1289001	Integral LED	4.2W	Mains 230V	3000	90	184	44	□	✓



ZIP



SHAVER LIGHT (1022001)



SHAVER LIGHT

ZONES **3**

	LAMP	WATT	IP	CLASS			
PCh 1022001	E14 LED ▼	2 x 7W max	20		✓	✓	✓

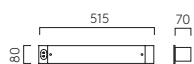

SHAVER LIGHT

Removable pull-cord switch/Tirette amovibile/Zugschalter entfernbar/Interruttore con filo a tirante rimovibile.

▼ Lamp excluded, see page 714/ La lampe exclu, voir page 714/ La lampadina esclusi a pagina 714/ Das Leuchtmittel ist ausgeschlossen, sie auf Seite 714.





CHIOS 80 (1310005)



CHIOS 150 (1310004)



CHIOS

ZONES 2 3

				LAMP	WATT	IP	CLASS		
80	1310002	1310005	1310007	GU10 LED▼	6W max	44		✓	✓
150	1310004	1310006	1310008	GU10 LED▼	2 x 6W max	44		✓	✓

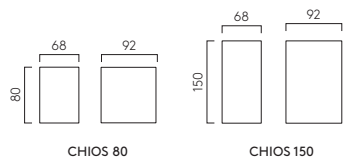

▼ Lamp excluded, see page 714 / La lampe exclu, voir page 714 / La lampadina esclusi a pagina 714 / Das Leuchtmittel ist ausgeschlossen, sie auf Seite 714.

LED



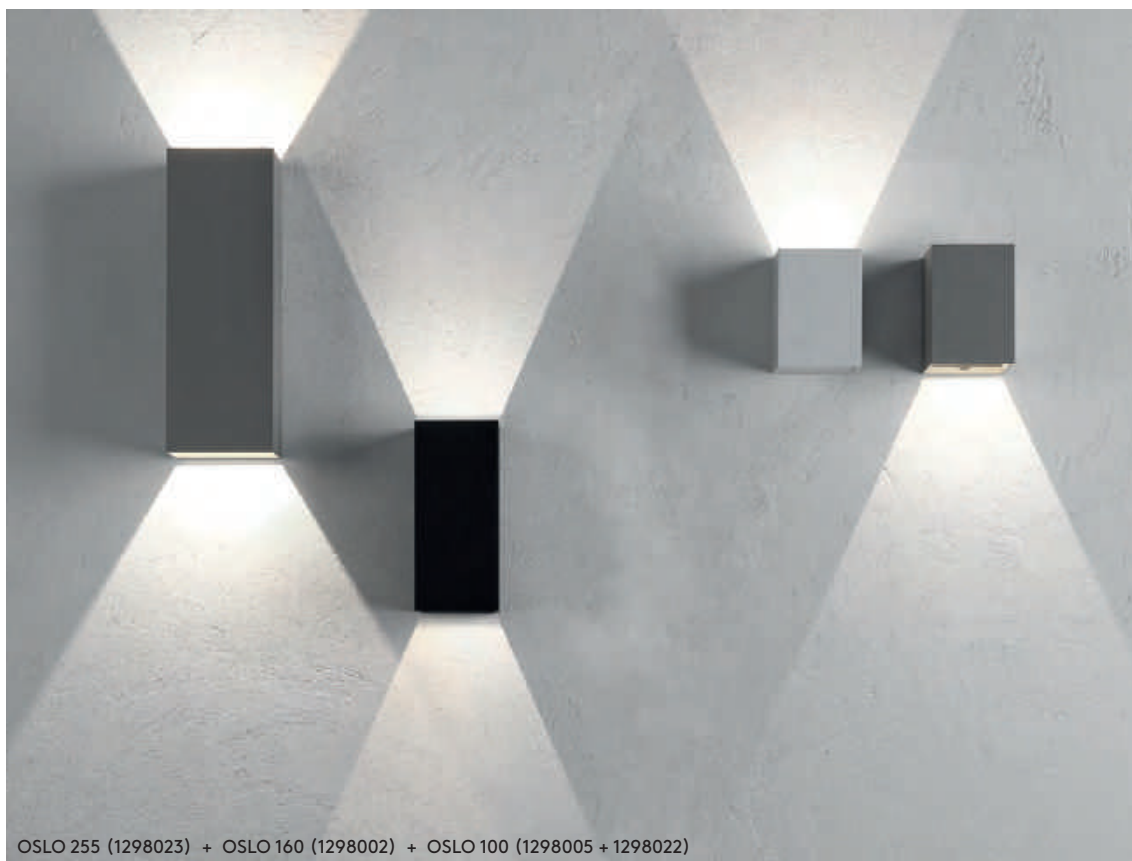

OSLO 255 (1298023) + OSLO 160 (1298002) + OSLO 100 (1298005 + 1298022)



OSLO

ZONES 1 2 3

				LAMP	WATT	INPUT	K	CRI	Lm	IP	CLASS	Ⓢ	Ⓜ
100	TB 1298004	TW 1298005	TG 1298022	Integral LED	3.8W	Mains 230V	3000	90	47	65	Ⓢ	✓	✓
160	TB 1298002	TW 1298006	TG 1298021	Integral LED	6W	Mains 230V	3000	90	99	65	Ⓢ	✓	✓
255	TB 1298007	TW 1298009	TG 1298023	Integral LED	7.5W	Mains 230V	3000	80	270	65	Ⓢ	-	✓

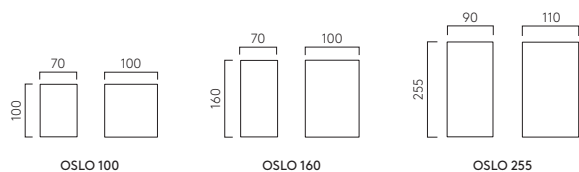



PCh MW

ORPHEUS

ZONES 1 2 3

	LAMP	WATT	INPUT	K	CRI	Lm	IP	CLASS			
1348001	Integral LED	2W	700mA▼	2700	90	66	65				
1348002											

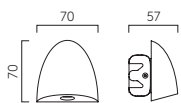

ORPHEUS

▼ Driver excluded, see page 713 / Driver exclu, voir page 713 / Driver esclusi a pagina 713 / Das treiber ist ausgeschlossen, sie auf Seite 713.

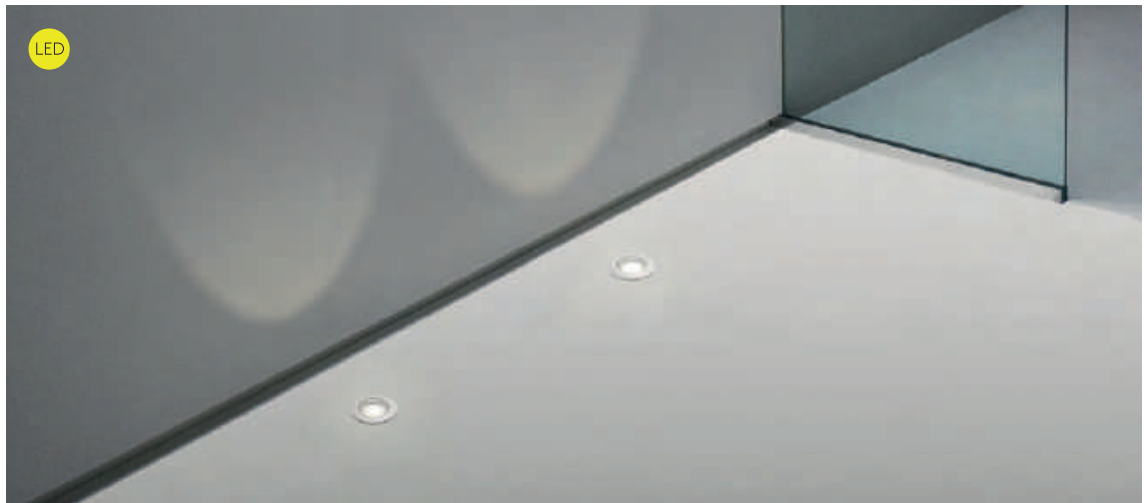

TERRA 42 (1201002)



TERRA 28 ROUND (1201003)



TERRA 28 SQUARE (1201004)



TERRA

ZONES 1 2 3

		LAMP	WATT	INPUT	K	CRI	Lm	IP	CLASS			
42	1201002	Integral LED	2.2W	700mA▼	3000	80	98	67		✓	✓	✓
90	1201001	Integral LED	4.2W	Mains 230V	3000	80	85	67		✓	-	✓
28 ROUND	1201003	Integral LED	1W	350mA▼	3000	80	40	65		✓	✓	✓
28 SQUARE	1201004	Integral LED	1W	350mA▼	3000	80	40	65		✓	✓	✓

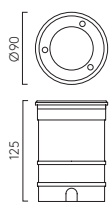

TERRA 90

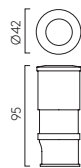

TERRA 42

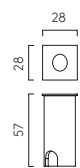

TERRA 28 SQUARE



TERRA 28 ROUND

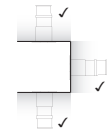

▼ Driver excluded, see page 713 / Driver exclu, voir page 713 / Driver esclusi a pagina 713 / Das treiber ist ausgeschlossen, sie auf Seite 713.



TANGO

ZONES 1 2 3

	LAMP	WATT	INPUT	K	CRI	Lm	IP	CLASS		
<p>PSS 1175005 BSS 1175002</p> <p>MW 1175001 TB 1175004</p>	Integral LED	1W	350mA▼	3000	90	23	65		✓	✓
<p>PSS 1175010 BSS 1175007</p> <p>MW 1175006 TB 1175009</p>	Integral LED	1W	350mA▼	2700	90	29	65		✓	✓

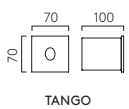

▼ Driver excluded, see page 713 / Driver exclu, voir page 713 / Driver esclusi a pagina 713 / Das treiber ist ausgeschlossen, sie auf Seite 713.



BORGEO 55 (1212010)



BORGEO 90 (1212009)



BORGEO

ZONES 1 2 3

					LAMP	WATT	INPUT	K	CRI	Lm	IP	CLASS	Ⓢ	Ⓣ	Ⓡ	
43	PSS	1212015	TW	1212017	BSS	1212016	Integral LED	1W	350mA CC▼	3000	90	15	65	Ⓢ	✓	✓
	PSS	1212029	TW	1212031	BSS	1212030	Integral LED	1W	350mA CC▼	2700	90	12	65	Ⓢ	✓	✓
	PSS	1212020	TW	1212019	BSS	1212018	Integral LED	1W	350mA CC▼	3000	90	30	65	Ⓢ	✓	✓
54	PSS	1212034	TW	1212033	BSS	1212032	Integral LED	1W	350mA CC▼	2700	90	30	65	Ⓢ	✓	✓
	PSS	1212010					Integral LED	2W	700mA CC▼	3000	90	39	65	Ⓢ	✓	✓
NEW 55MV	PSS	1212043	MW	1212045	BSS	1212044	Integral LED	4.1W	Mains 230V	3000	80	48	65	Ⓢ	✓	✓
	TW	1212050	TB	1212049												
90	PSS	1212009					Integral LED	2W	700mA CC▼	3000	90	72	65	Ⓢ	✓	✓
NEW 90MV	PSS	1212046	MW	1212048	BSS	1212047	Integral LED	4.1W	Mains 230V	3000	80	124	65	Ⓢ	✓	✓
	TW	1212052	TB	1212051												

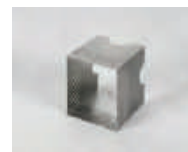
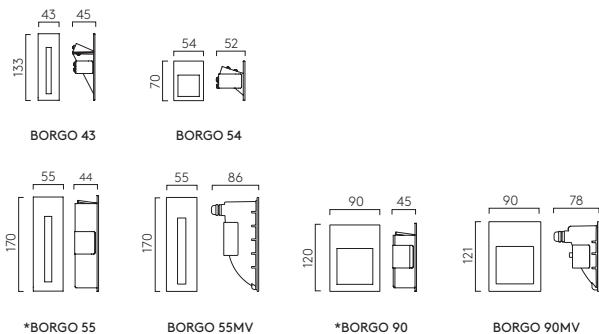

90 WALL BOX 6013002
H.108mm W.87mm D.100mm



55 WALL BOX 6013001
H.165mm W.51mm D.100mm

* A wall box accessory is available for installation of the Borgeo 55 and 90 into brick walls / Accessoire mural disponible pour l'installation de la gamme Borgeo dans des murs en brique / Als Zubehör sind Wandkästen erhältlich, die eine Installation der Borgeo Serie in Ziegelwänden ermöglichen. / Un accessorio per le pareti è disponibile per l'installazione del Borgeo in muri di mattoni.

LED Driver accessible after installation / Driver LED accessibles après installation / LED-Treiber ist nach der Installation zugänglich / Accesso al driver anche dopo l'installazione

▼ Driver excluded, see page 713 / Driver d'entrée exclu, voir page 713 / Driver esclusi a pagina 713 / Das treiber ist ausgeschlossen, sie auf Seite 713.





ROMA (1050001) + MIRROR MOUNTING KIT 1 (6001003)

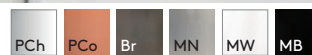

MIRROR MOUNTING KIT

DIMENSIONS

KIT 1 PCh PCo Br MN MW MB 6001003

Ø80mm D:12mm

KIT 2 PCh 6001002

Ø25mm D:21mm

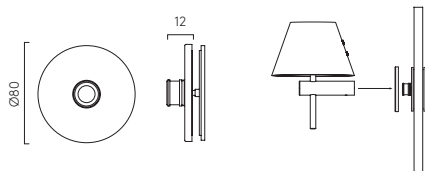

MIRROR MOUNTING KIT 1

For use with / convient pour / zur Verwendung mit / da utilizzare con: Tube, Roma (excluding Roma Switched 1050002) & Arezzo.

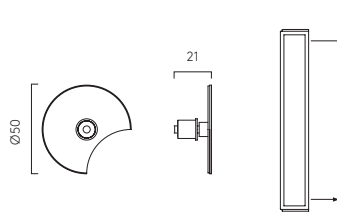

MIRROR MOUNTING KIT 2

For use with / convient pour / zur Verwendung mit / da utilizzare con: Palermo, Romano, Belgravia, Mashiko, Axios, Sparta, Artemis, Versailles, Monza LED, Altea 360 & 500 & Boston.



ILLUMINATED MIRRORS

MIROIRS · SPIEGEL · SPECCHI

ILLUMINATED MIRROR



●
IMOLA 900
P. 121



●
AVLON 900
P. 123



●
AVLON 1200
P. 123



●
MASCALI ROUND
P. 125



●
MASCALI SQUARE
P. 125



●
NIIMI ROUND
P. 127



●
NIIMI SQUARE
P. 127



●
CATENA
P. 129

LED



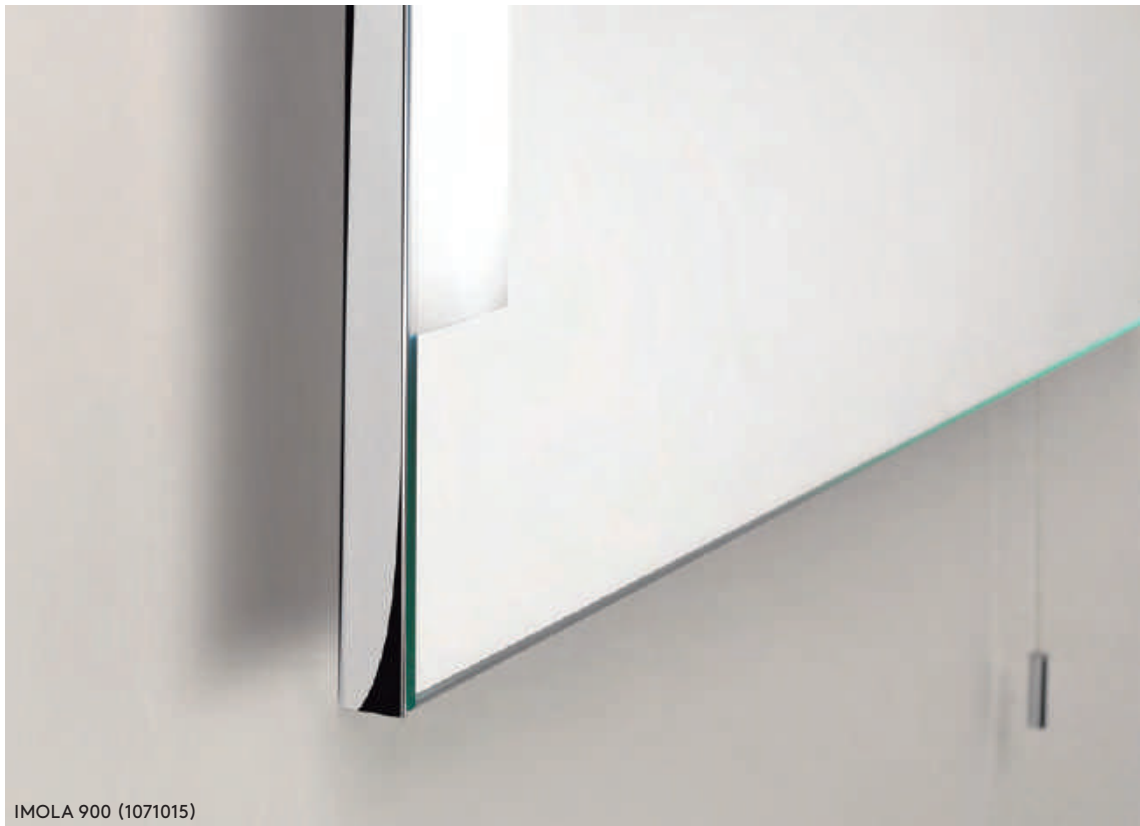

IMOLA 900 (1071015)



IMOLA 900

ZONES 2 3

	LAMP	WATT	INPUT	K	CRI	Lm	IP	CLASS	<input type="checkbox"/>	<input checked="" type="checkbox"/>
1071015	Integral LED	26.9W	Mains 230V	3000	80	415	44	<input type="checkbox"/>	<input checked="" type="checkbox"/>	<input checked="" type="checkbox"/>

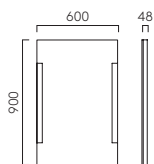

IMOLA 900

LED





AVLON 900 (1359017)



AVLON

ZONES 2 3

		LAMP	WATT	INPUT	K	CRI	Lm	IP	CLASS	ⓧ
900	1359017	Integral LED	24.6W	Mains 230V	3000	80	286	44		✓
1200	1359016	Integral LED	25.1W	Mains 230V	3000	80	460	44		✓

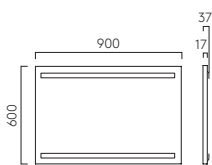

AVLON 900

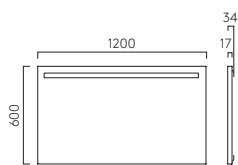

AVLON 1200

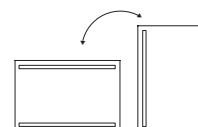

AVLON 900 (1359017)

LED

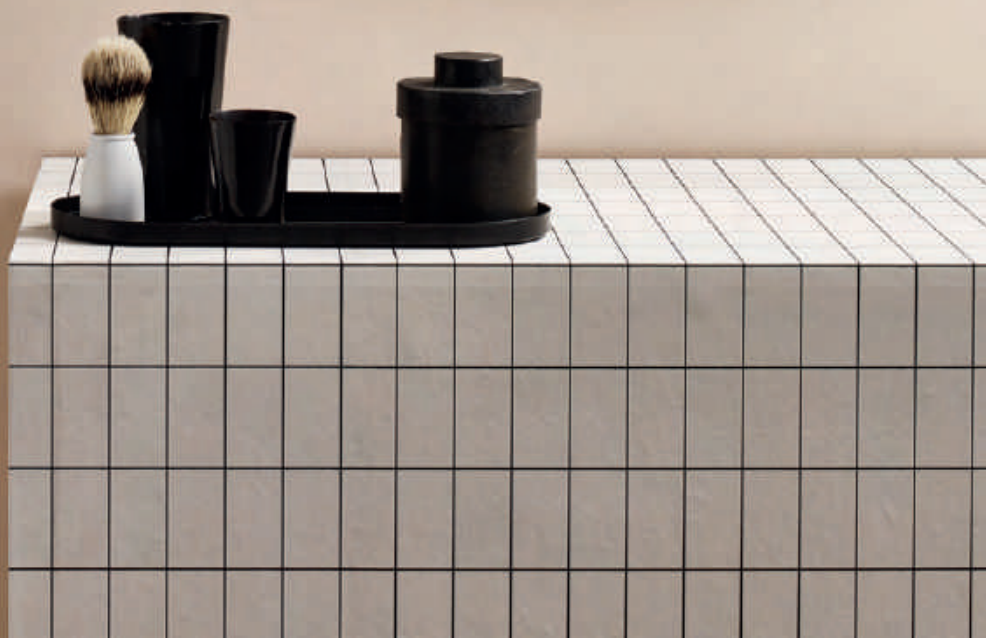

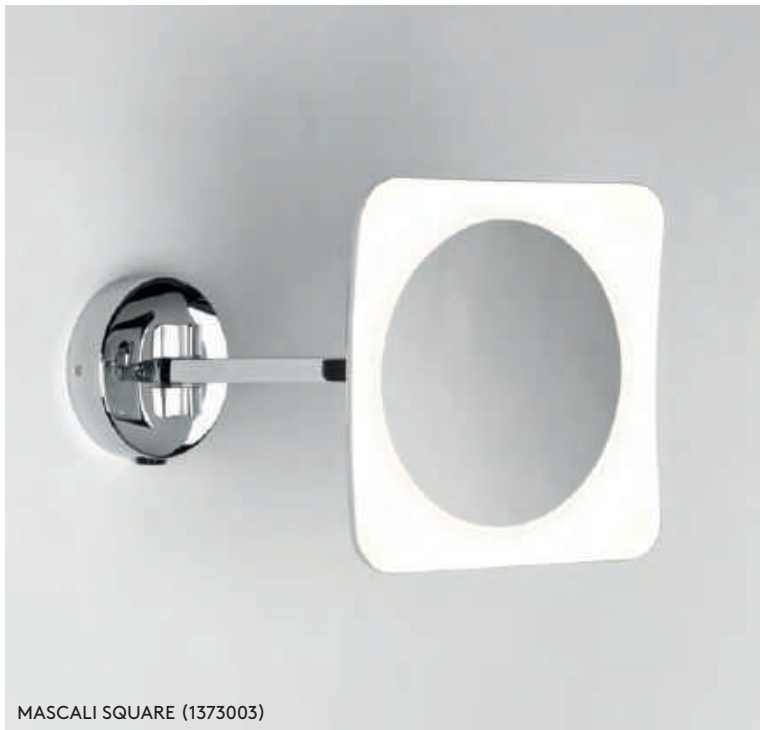

MASCALI

ZONES 2 3

	LAMP	WATT	INPUT	K	CRI	Lm	IP	CLASS	I	Ⓢ	Ⓜ	Ⓝ
SQUARE PCh 1373003	Integral LED	6.1W	Mains 230V	2700	80	153	44	□	✓	✓	✓	✓
ROUND PCh 1373001 MN 1373006	Integral LED	5.3W	Mains 230V	2700	80	76	44	□	✓	✓	✓	✓

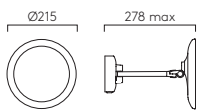

MASCALI ROUND

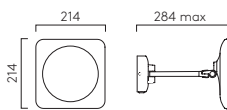

MASCALI SQUARE

Recommended for hospitality use / Recommandé pour l'hôtellerie / Zur Verwendung im Gastgewerbe geeignet / Adatto in strutture alberghiere.

LED





NIIMI ROUND (1163003)



NIIMI SQUARE (1163002)



NIIMI

ZONES 2 3

	PCh	MN	LAMP	WATT	INPUT	K	CRI	IP	CLASS	I	Ⓢ	Ⓜ
ROUND	1163001	1163003	Integral LED	5.2W	Mains 230V	3000	65	44	□	✓	✓	✓
SQUARE	1163002		Integral LED	5.2W	Mains 230V	3000	65	44	□	✓	✓	✓

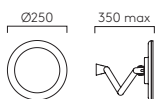

ZTVV ROUND

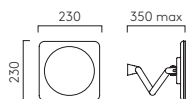

NIIMI SQUARE

LED





CATENA (1137003)



CATENA (1137003)



CATENA

ZONES 2 3

	LAMP	WATT	INPUT	K	CRI	Lm	IP	CLASS				
1137003	Integral LED	12.4W	Mains 230V	3000	80	216	44		<input checked="" type="checkbox"/>	<input checked="" type="checkbox"/>	<input checked="" type="checkbox"/>	<input checked="" type="checkbox"/>

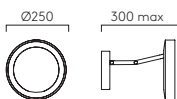

CATENA

Recommended for hospitality use / Recommandé pour l'hôtellerie / Zur Verwendung im Gastgewerbe geeignet / Adatto in strutture alberghiere.

▼ Lamp excluded, see page 714 / La lampe exclu, voir page 714 / La lampadina esclusi a pagina 714 / Das Leuchtmittel ist ausgeschlossen, sie auf Seite 714.

LED





OTTAVINO PENDANT (1411002)



NEW OTTAVINO PENDANT

ZONES 2 3

	LAMP	WATT	IP	CLASS		
PCh 1411002	E14 LED▼	5W max	44		✓	✓



OTTAVINO PENDANT

▼ Lamp excluded, see page 714 / La lampe exclu, voir page 714 / La lampadina esclusi a pagina 714 / Das Leuchtmittel ist ausgeschlossen, sie auf Seite 714.

LED





KYOTO PENDANT (1060007)



KYOTO PENDANT (1060008)

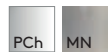

KYOTO PENDANT

ZONES 2 3

	LAMP	WATT	INPUT	K	CRI	Lm	IP	CLASS		
PCh 1060007	Integral LED	7.8W	Mains 230V	3000	80	411	44		<input checked="" type="checkbox"/>	<input checked="" type="checkbox"/>
MN 1060008										

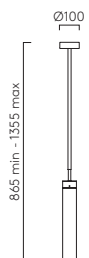

KYOTO PENDANT

LED





KIWI PENDANT (1390004)



KIWI PENDANT

ZONES **2 3**

	LAMP	WATT	INPUT	K	CRI	Lm	IP	CLASS		
PCh 1390004	Integral LED	7.6W	Mains 230V	2700	80	518	44		✓	✓



KIWI PENDANT



P. 73



P. 159

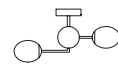

P. 139



P. 135



CEILING LIGHTS

LUMINAIRES DE PLAFOND · DECKENLEUCHTEN · LAMPADE DA SOFFITTO



●
KIWI THREE
P. 139



●
MASHIKO SQUARE
P. 141



●
MASHIKO ROUND
P. 143



●
TAKETA LED
P. 145



●
MALLON
P. 147



●
ALTEA
P. 149



●
OSAKA
P. 151



●
DAKOTA
P. 153



●
DENIA
P. 155



●
SABINA 280
P. 157



●
SABINA 170
P. 157



●
SABINA SQUARE
P. 157



●
KIWI CEILING
P. 159



●
ZEPP0 CEILING
P. 161



●
DENVER
P. 163



●
AREZZO CEILING
P. 165



●
ASINI
P. 166



●
SYROS
P. 167

LED

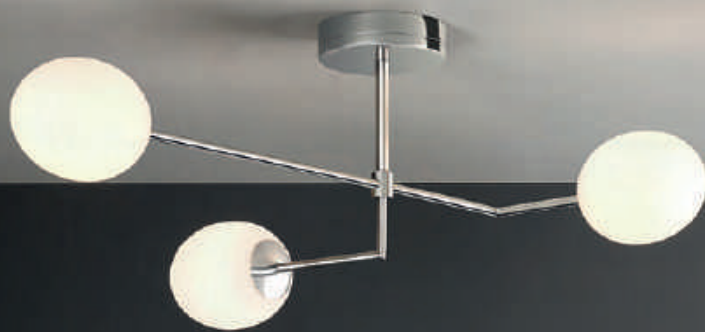



KIWI THREE (1390005)



KIWI THREE

ZONES **2 3**

	LAMP	WATT	INPUT	K	CRI	Lm	IP	CLASS	Ⓢ	🌐
PCh 1390005	Integral LED	21.2W	Mains 230V	2700	80	1575	44	☐	✓	✓

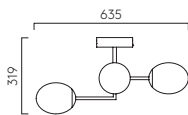

KIWI THREE



P. 73



P. 159



P. 139



P. 135

LED





MASHIKO SQUARE 400 LED (1121069)



MASHIKO SQUARE 200 (1121009)

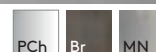

MASHIKO SQUARE

ZONES 2 3

				LAMP	WATT	INPUT	K	CRI	Lm	IP	CLASS			
200	1121009	1121056		E27 LED ▼	12W max	-	-	-	-	44		✓	✓	-
300 LED	1121040	1121062	1121071	Integral LED	16W	Mains 230V	2700	80	931	44		-	✓	✓
CLASSIC 300	1121005			E27 LED ▼	2 x 12W max	-	-	-	-	44		✓	✓	-
400	1121010	1121013		E27 LED ▼	4 x 12W max	-	-	-	-	44		✓	✓	-
400 LED	1121067	1121069		Integral LED	27.4W	Mains 230V	3000	80	2458	44		✓	✓	✓

EMERGENCY

400 LED basic	1121075	1121076		Integral LED	31.2W	Mains 230V	3000	80	2438	44		✓	✓	✓
400 LED selftest	1121072	1121074		Integral LED	31.2W	Mains 230V	3000	80	2438	44		✓	✓	✓



MASHIKO 200

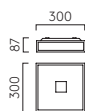

MASHIKO 300 LED / CLASSIC 300

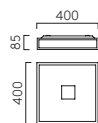

MASHIKO 400 / 400 LED / EMERGENCY 400 BASIC & SELFTEST

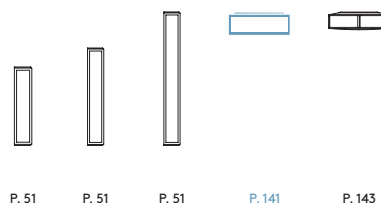

▼ Lamp excluded, see page 714 / La lampe exclu, voir page 714 / La lampadina esclusi a pagina 714 / Das Leuchtmittel ist ausgeschlossen, sie auf Seite 714.

LED





MASHIKO ROUND 230 (1121021)



MASHIKO ROUND 300 LED (1121045)



MASHIKO ROUND

ZONES 2 3

	LAMP	WATT	INPUT	K	CRI	Lm	IP	CLASS	☾	⊗	⊙
230	1121021	E27 LED▼	12W max	-	-	-	44		✓	✓	-
300	1121017 1121043	E27 LED▼	12W max	-	-	-	44		✓	✓	-
300 LED	1121041 1121045	Integral LED	16.4W	Mains 230V	2700	80	892	44		-	✓
400	1121026	E27 LED▼	3 x 12W max	-	-	-	44		✓	✓	-

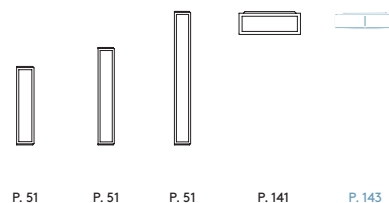
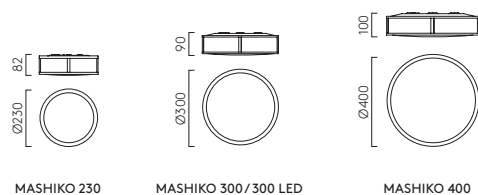

▼ Lamp excluded, see page 714 / La lampe exclu, voir page 714 / La lampadina esclusi a pagina 714 / Das Leuchtmittel ist ausgeschlossen, sie auf Seite 714.

LED





TAKETA 400 LED (1169015)



TAKETA 400 LED EMERGENCY (1169021)



TAKETA

ZONES 2 3

				LAMP	WATT	INPUT	K	CRI	Lm	IP	CLASS		
				Integral LED	16.3W	Mains 230V	2700	80	834	44		-	✓
NEW	400 LED	1169014	1169015	1169020	Integral LED	27.4W	Mains 230V	3000	83	2161	44		✓ ✓

EMERGENCY

NEW	400 LED basic	1169018	1169019	1169022	Integral LED	27.4W	Mains 230V	3000	83	2161	44		✓ ✓
NEW	400 LED selftest	1169016	1169017	1169021	Integral LED	27.4W	Mains 230V	3000	83	2161	44		✓ ✓

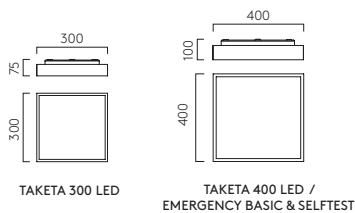

LED





MALLON LED (1125005)



MALLON LED (1125006)



MALLON LED

ZONES 2 3

	LAMP	WATT	INPUT	K	CRI	Lm	IP	CLASS	Ⓢ	Ⓜ
PCh 1125004 MN 1125005 Br 1125006	Integral LED	16.2W max	Mains 230V	2700	80	732	44	□	✓	✓

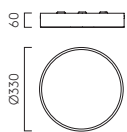

MALLON LED

LED





ALTEA 150 LED (1133004)



ALTEA 300 LED (1133007)



ALTEA

ZONES 2 3

		LAMP	WATT	INPUT	K	CRI	Lm	IP	CLASS	☾	ⓧ
150 LED	1133004	Integral LED	7.7W	Mains 230V	2700	80	346	44		✓	-
300 LED	1133007	Integral LED	15.6W	Mains 230V	2700	80	673	44		-	✓
300	1133002	E27 LED ▼	12W max	-	-	-	-	44		✓	✓

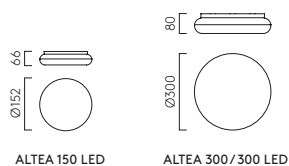

ALTEA 150 LED

ALTEA 300/300 LED

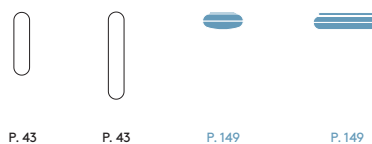

▼ Lamp excluded, see page 714 / La lampe exclu, voir page 714 / La lampadina esclusi a pagina 714 / Das Leuchtmittel ist ausgeschlossen, sie auf Seite 714.

LED





OSAKA 350 LED (1061006)



OSAKA

ZONES 2 3

	LAMP	WATT	INPUT	K	CRI	Lm	IP	CLASS	
LED	PCh 1061009	Integral LED	16W max	Mains 230V	2700	80	1048	44	
350 LED	PCh 1061006	Integral LED	23W max	Mains 230V	3000	80	1812	44	

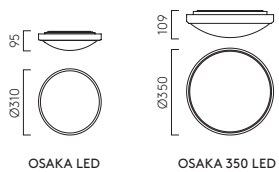

LED





DAKOTA 180 (1129006)



DAKOTA

ZONES 2 3

			LAMP	WATT	INPUT	K	CRI	Lm	IP	CLASS		
180	1129006		E14 LED ▼	7W max	-	-	-	-	44		✓	✓
300	1129001		E27 LED ▼	12W max	-	-	-	-	44		✓	✓
300 LED	1129007		Integral LED	16W	Mains 230V	2700	80	748	44		-	✓



DAKOTA 180

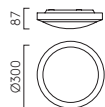

DAKOTA 300 LED

▼ Lamp excluded, see page 714 / La lampe exclu, voir page 714 / La lampadina esclusi a pagina 714 / Das Leuchtmittel ist ausgeschlossen, sie auf Seite 714.





DENIA (1134001)



DENIA

ZONES 2 3

	LAMP	WATT	IP	CLASS		
1134001	E14 LED▼	2 x E14 LED	44		<input checked="" type="checkbox"/>	<input checked="" type="checkbox"/>

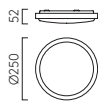

DENIA

▼ Lamp excluded, see page 714 / La lampe exclu, voir page 714 / La lampadina esclusi a pagina 714 / Das Leuchtmittel ist ausgeschlossen, sie auf Seite 714.

LED





SABINA 170 (1292001)



SABINA SQUARE (1292002)



SABINA

ZONES 2 3

		LAMP	WATT	INPUT	K	CRI	Lm	IP	CLASS		
170	1292001	E27 LED ▼	12W max	-	-	-	-	44		✓	✓
280	1292003	E27 LED ▼	12W max	-	-	-	-	44		✓	✓
280 LED	1292007	Integral LED	16W	Mains 230V	2700	80	931	44		-	✓
SQUARE	1292002	E27 LED ▼	12W max	-	-	-	-	44		✓	✓

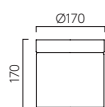

SABINA 170

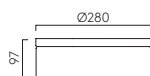

SABINA 280/280 LED

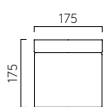

SABINA SQUARE

▼ Lamp excluded, see page 714 / La lampe exclu, voir page 714 / La lampadina esclusi a pagina 714 / Das Leuchtmittel ist ausgeschlossen, sie auf Seite 714.

LED





KIWI CEILING (1390002)



KIWI CEILING

ZONES **2 3**

	LAMP	WATT	INPUT	K	CRI	Lm	IP	CLASS		
PCh 1390002	Integral LED	7.3W	Mains 230V	2700	80	555	44		<input checked="" type="checkbox"/>	<input checked="" type="checkbox"/>

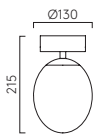

KIWI CEILING



P. 73



P. 159

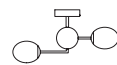

P. 139



P. 135

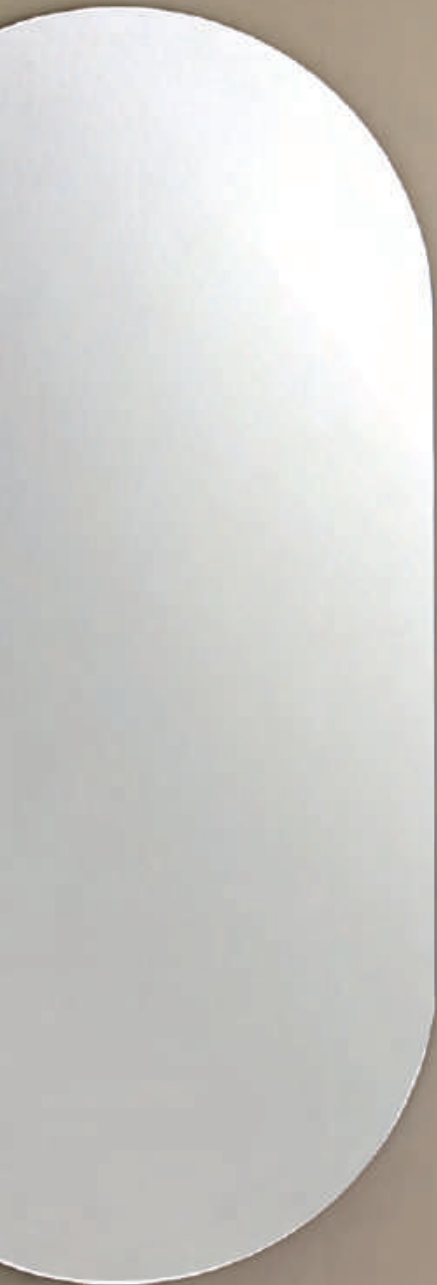



ZEPP0 CEILING (1176001)



ZEPP0 CEILING

ZONES 2 3

	LAMP	WATT	IP	CLASS		
1176001	E27 LED ▼	12W max	44		✓	✓

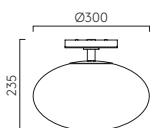

ZEPP0 CEILING

▼ Lamp excluded, see page 714 / La lampe exclu, voir page 714 / La lampadina esclusi a pagina 714 / Das Leuchtmittel ist ausgeschlossen, sie auf Seite 714.





DENVER (1038001)



DENVER

ZONES **2 3**

	LAMP	WATT	IP	CLASS		
1038001	G9 LED ▼	3W max	44		✓	✓

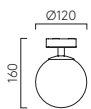

DENVER

▼ Lamp excluded, see page 714 / La lampe exclu, voir page 714 / La lampadina esclusi a pagina 714 / Das Leuchtmittel ist ausgeschlossen, sie auf Seite 714.





AREZZO CEILING (1049003)

PCh

AREZZO CEILING

ZONES **2 3**

	LAMP	WATT	IP	CLASS		
PCh 1049003	E27 LED▼	12W max	44		<input checked="" type="checkbox"/>	<input checked="" type="checkbox"/>



AREZZO CEILING

▼ Lamp excluded, see page 714 / La lampe exclu, voir page 714 / La lampadina esclusi a pagina 714 / Das Leuchtmittel ist ausgeschlossen, sie auf Seite 714.



ASINI (1324001)

PCh

ASINI

ZONES 2 3

	LAMP	WATT	IP	CLASS		
PCh 1324001	G9 LED ▼	3 x 3W max	44		✓	✓

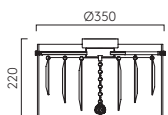

ASINI

▼ Lamp excluded, see page 714 / La lampe exclu, voir page 714 / La lampadina esclusi a pagina 714 / Das Leuchtmittel ist ausgeschlossen, sie auf Seite 714.



SYROS (1328001)

WG

SYROS

ZONES 2 3

	LAMP	WATT	IP	CLASS		
WG 1328001	E27 LED ▼	3 x 12W max	44		✓	✓

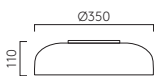

SYROS

▼ Lamp excluded, see page 714 / La lampe exclu, voir page 714 / La lampadina esclusi a pagina 714 / Das Leuchtmittel ist ausgeschlossen, sie auf Seite 714.



DOWNLIGHTS

DOWNLIGHTS · EINBAUSTRAHLER · FARETI DE INCASSO



●
VOID
P. 171



TRIMLESS ROUND
P. 173



TRIMLESS SQUARE
P. 173



●
MINIMA ROUND
P. 175



●
MINIMA SQUARE
P. 175



●
VETRO ROUND
P. 177



●
VETRO SQUARE
P. 177



VETRO TWIN
P. 177



●
OBSCURA ROUND
P. 179



●
OBSCURA SQUARE
P. 179



●
KOS ROUND
P. 181



●
KOS SQUARE
P. 181



VANCOUVER
P. 183



●
TERRA 28 ROUND
P. 185



●
TERRA 28 SQUARE
P. 185

LED 55 LED



LED 80 LED



LED 100 LED



THE VOID RANGE MUST BE INSTALLED BEFORE PLASTERING

La gamme Void doit être impérativement installée avant plafonnage. / Die Void Produktreihe muss vor dem Verputzen eingebaut werden. / La linea Void deve essere installata prima della posa del controsoffitto.

▶ TO VIEW A 'HOW TO INSTALL' VIDEO, PLEASE VISIT:
ASTROLIGHTING.COM

La gamme Void doit être impérativement installée avant plafonnage. Pour visionner une "vidéo d'installation" veuillez visiter. / Die Void Produktreihe muss vor dem Verputzen eingebaut werden. Um ein Montagevideo anzusehen, besuchen Sie bitte. / La linea Void deve essere installata prima della posa del controsoffitto. Per visualizzare un video su 'come installare' visitate il nostro sito.

VOID

ZONES 1 2 3



55

	LAMP	WATT	INPUT	K	CRI	Lm	IP	CLASS					
MW 1392004	Integral LED	6.8W	700mA▼	2700	80	501	65	◆	Ø70	✓	25°	✓	✓
MW 1392001	Integral LED	6.8W	700mA▼	3000	80	525	65	◆	Ø70	✓	25°	✓	✓
MW 1392017 MB 1392018	GU10 LED▼	6W max	-	-	-	-	65	□	Ø73	✓	-	✓	-

80

MW 1392002	Integral LED	9.1W	250mA▼	3000	80	877	65	◆	Ø95	✓	25°	✓	✓
MW 1392005	Integral LED	9.1W	250mA▼	2700	80	863	65	◆	Ø95	✓	14°	✓	✓
MW 1392006	Integral LED	9.1W	250mA▼	2700	93	690	65	◆	Ø95	✓	14°	✓	✓
MW 1392007	Integral LED	9.1W	250mA▼	3000	80	888	65	◆	Ø95	✓	14°	✓	✓
MW 1392008	Integral LED	9.1W	250mA▼	3000	93	668	65	◆	Ø95	✓	14°	✓	✓
MW 1392009	Integral LED	9.1W	250mA▼	2700	93	611	65	◆	Ø95	✓	25°	✓	✓
MW 1392010	Integral LED	9.1W	250mA▼	3000	93	653	65	◆	Ø95	✓	25°	✓	✓
MW 1392012	Integral LED	9.1W	250mA▼	2700	80	840	65	◆	Ø95	✓	25°	✓	✓
MW 1392019 MB 1392016	GU10 LED▼	6W max	-	-	-	-	65	□	Ø98	✓	-	✓	-

100

MW 1392003	Integral LED	12.7W	350mA▼	3000	80	1230	65	◆	Ø117	✓	25°	✓	✓
MW 1392011	Integral LED	12.7W	350mA▼	2700	80	1219	65	◆	Ø117	✓	25°	✓	✓

ACCESSORIES



55 BLACK BEZEL
1392013



80 BLACK BEZEL
1392014



100 BLACK BEZEL
1392015

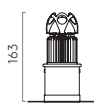

VOID 55 LED

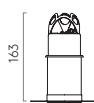

VOID 55 GU10



VOID 80 LED

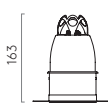

VOID 80 GU10

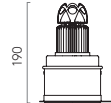

VOID 100 LED

⚡ Our fire rated downlights comply with all the latest building regulations: Part B - Fire Safety. The downlights have been tested to provide a minimum of 90 minutes fire protection (BS 476: part 21).

▼ Lamp or driver excluded, see page 713 / La lampe / driver exclu, voir page 713 / La lampadina / driver esclusi a pagina 713 Das Leuchtmittel / treiber ist ausgeschlossen, sie auf Seite 713.



THE TRIMLESS RANGE
MUST BE INSTALLED
BEFORE PLASTERING

La gamme Trimless doit être impérativement installée avant plafonnage. / Die Trimless Produktreihe muss vor dem Verputzen eingebaut werden. / La linea Trimless deve essere installata prima della posa del controsoffitto.

▶ TO VIEW A 'HOW TO INSTALL' VIDEO,
PLEASE VISIT: ASTROLIGHTING.COM

La gamme Trimless doit être impérativement installée avant plafonnage. Pour visionner une "vidéo d'installation" veuillez visiter. / Die Trimless Produktreihe muss vor dem Verputzen eingebaut werden. Um ein Montagevideo anzusehen, besuchen Sie bitte. / La linea Trimless deve essere installata prima della posa del controsoffitto. Per visualizzare un video su 'come installare' visitate il nostro sito.



TRIMLESS ROUND FIXED (1248001)



TRIMLESS SQUARE FIXED (1248005)



TRIMLESS

ZONES 1 2 3

	LAMP	WATT	INPUT	IP	CLASS				
ROUND FIXED									
1248001	GU5.3 LED ▼	6W max	12V ▼	65		Ø86	✓	✓	✓
1248002	GU10 LED ▼	6W max	-	65		Ø86	✓	✓	✓
SQUARE FIXED									
1248005	GU10 LED ▼	6W max	-	65		W: 95 H: 95	✓	✓	-

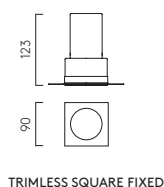
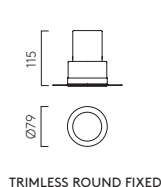

⚡ Our fire rated downlights comply with all the latest building regulations: Part B - Fire Safety. The downlights have been tested to provide a minimum of 90 minutes fire protection (BS 476: part 21).

▼ Lamp/transformer excluded, see page 714/ La lampe exclu, voir page 714/ La lampadina esclusi a pagina 714/ Das Leuchtmittel ist ausgeschlossen, sie auf Seite 714.

LED



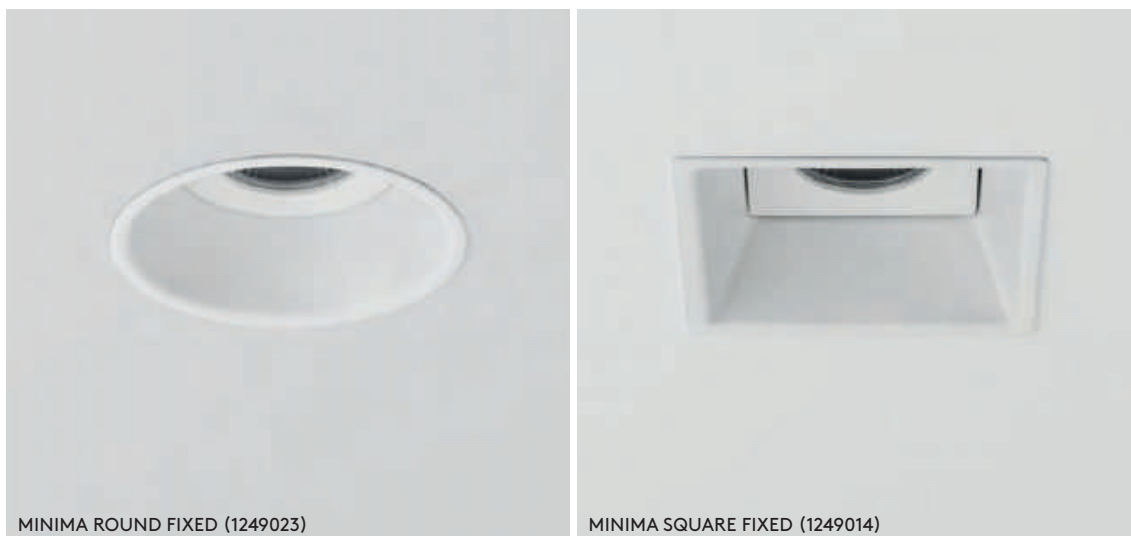

MINIMA ROUND FIXED (1249023)

MINIMA SQUARE FIXED (1249014)



MINIMA

ZONES 1 2 3

	LAMP	WATT	INPUT	K	CRI	Lm	IP	CLASS					
ROUND FIXED													
1249023	Integral LED	6.1W	Mains 230V	2700	90	665	65	◇	Ø86	✓	45°	✓	✓
1249012 1249017	GU10 LED [▼]	6W max	-	-	-	-	65	□	Ø76	✓	-	-	-
SQUARE FIXED													
1249024	Integral LED	6.1W	Mains 230V	2700	90	678	65	◇	W: 86 H: 86	✓	45°	✓	✓
1249018	GU10 LED [▼]	6W max	-	-	-	-	65	□	Ø76	✓	-	-	-



MINIMA ROUND FIXED LED

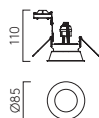

MINIMA ROUND FIXED GU10

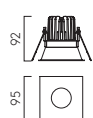

MINIMA SQUARE FIXED LED

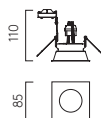

MINIMA SQUARE FIXED GU10

⚡ Our fire rated downlights comply with all the latest building regulations: Part B - Fire Safety. The downlights have been tested to provide a minimum of 90 minutes fire protection (BS 476: part 21).

▼ Lamp excluded, see page 714 / La lampe exclu, voir page 714 / La lampadina esclusi a pagina 714 / Das Leuchtmittel ist ausgeschlossen, sie auf Seite 714.

LED





VETRO TWIN (1254015)



VETRO SQUARE (1254017)



VETRO

ZONES 1 2 3

ROUND		LAMP	WATT	INPUT	K	CRI	Lm	IP	CLASS	☐	☐	☐	☐	☐	☐
Wh 1254013	Bk 1254016	Integral LED	6W	350mA▼	3000	80	629	65	☐	Ø70	✓	18°	-	✓	✓
Wh 1254009	Bk 1254010	Integral LED	6W	350mA▼	2700	80	594	65	☐	Ø76	✓	18°	✓	✓	✓
SQUARE															
Wh 1254014	Bk 1254017	Integral LED	6W	350mA▼	3000	80	629	65	☐	Ø79	✓	18°	-	✓	✓
Wh 1254007	Bk 1254008	Integral LED	6W	350mA▼	2700	80	594	65	☐	Ø76	✓	18°	✓	✓	✓
TWIN															
Wh 1254015	Bk 1254018	Integral LED	2 x 6W	350mA▼	3000	80	1232	65	☐	H: 160 W: 80	✓	18°	-	✓	✓

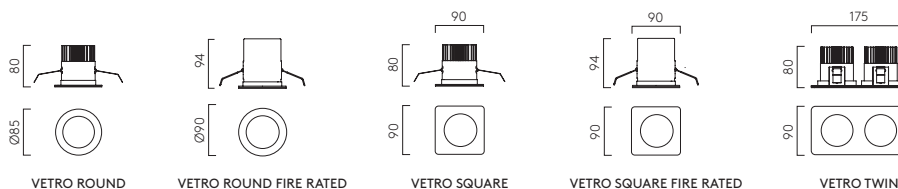

☐ Our fire rated downlights comply with all the latest building regulations: Part B - Fire Safety. The downlights have been tested to provide a minimum of 90 minutes fire protection (BS 476: part 21).

▼ Driver excluded, see page 713 / Driver exclu, voir page 713 / Driver esclusi a pagina 713 / Das treiber ist ausgeschlossen, sie auf Seite 713.

LED





OBSCURA SQUARE (1381005)



OBSCURA ROUND (1381006)



OBSCURA

ZONES 1 2 3

ROUND		LAMP	WATT	INPUT	K	CRI	Lm	IP	CLASS				
1381007	1381006	Integral LED	6.1W	Mains 230V	2700	90	388	65		Ø70	✓	✓	✓
SQUARE													
1381005	1381008	Integral LED	6.1W	Mains 230V	2700	90	388	65		Ø70	✓	✓	✓

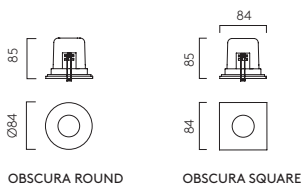

Our fire rated downlights comply with all the latest building regulations: Part B - Fire Safety. The downlights have been tested to provide a minimum of 90 minutes fire protection (BS 476: part 21).

LED





KOS

ZONES 1 2 3

	LAMP	WATT	IP	CLASS	⏻	ⓧ
ROUND						
TG 1326041 MW 1326039 TB 1326040 PCh 1326042	GU10 LED▼	6W max	65	⊕	✓	✓
100 LED TG 1326024 TW 1326025 TB 1326023	Integral LED	6.3W	65	⊞	phase	✓
140 LED TG 1326018 TW 1326019 TB 1326017	Integral LED	12.4W	65	⊞	phase	✓
SQUARE						
TG 1326045 MW 1326043 TB 1326044 PCh 1326046	GU10 LED▼	6W max	65	⊕	✓	✓
100 LED TG 1326027 TW 1326028 TB 1326026	Integral LED	6.3W	65	⊞	phase	✓
140 LED TG 1326021 TW 1326022 TB 1326020	Integral LED	12.4W	65	⊞	phase	✓

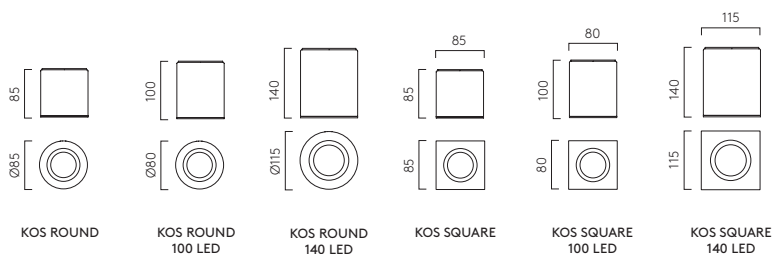

▼ Lamp excluded, see page 714/La lampe exclu, voir page 714/La lampadina esclusi a pagina 714/Das Leuchtmittel ist ausgeschlossen, sie auf Seite 714.

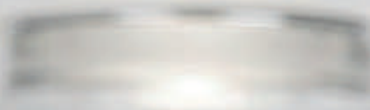



VANCOUVER SQUARE (1229004)



VANCOUVER SQUARE 90 (1229012)



VANCOUVER ROUND 90 (1229013)



VANCOUVER

ZONES 1 2 3

		LAMP	WATT	INPUT	K	CRI	Lm	IP	CLASS	☐	Ⓢ
ROUND	CA PCh 1229003	GU10 LED▼	6W max	-	-	-	-	65	☐	Ø90	✓
SQUARE	CA PCh 1229004	GU10 LED▼	6W max	-	-	-	-	65	☐	Ø90	✓
ROUND 90	CA PCh 1229012	Integral LED	6W	350mA▼	3000	80	681	44	Ⓢ	Ø79	✓
SQUARE 90	CA PCh 1229013	Integral LED	6W	350mA▼	3000	80	755	44	Ⓢ	Ø76	✓

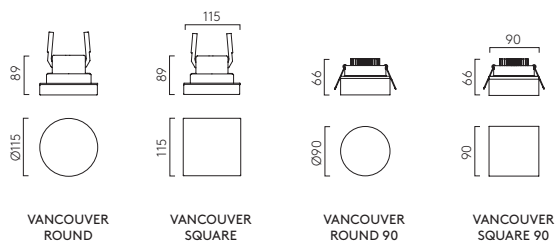

▼ Lamp/driver excluded, see page 714 / La lampe exclu, voir page 714 / La lampadina esclusi a pagina 714 / Das Leuchtmittel ist ausgeschlossen, sie auf Seite 714.

LED





TERRA 28 ROUND (1201003)



TERRA 28 SQUARE (1201004)

BSS

TERRA 28

ZONES 1 2 3

	LAMP	WATT	INPUT	K	CRI	Lm	IP	CLASS		
ROUND BSS 1201003	Integral LED	1W	350mA▼	3000	80	40	65		Ø25	✓
SQUARE BSS 1201004	Integral LED	1W	350mA▼	3000	80	40	65		Ø25	✓

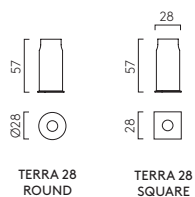

▼ Driver excluded, see page 713 / Driver exclu, voir page 713 / Driver esclusi a pagina 713 / Das treiber ist ausgeschlossen, sie auf Seite 713.



SPOTLIGHTS

SPOTS · SPOLIGHTS · RIFLETTORI ORIENTABILI



AQUA RECESS
P. 189



AQUA SINGLE
P. 189



AQUA TRIPLE ROUND
P. 189



AQUA TRIPLE BAR
P. 189



COMO SINGLE
P. 191



COMO TWIN
P. 191



COMO TRIPLE ROUND
P. 191



COMO TRIPLE BAR
P. 191

LED





AQUA SINGLE (1393004)



AQUA TRIPLE ROUND (1393002)

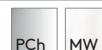

AQUA

ZONES 2 3

				LAMP	WATT	IP	CLASS		
SINGLE	1393004	1393001		GU10 LED▼	6W max	44		✓	✓
TRIPLE BAR	1393006	1393003		GU10 LED▼	3 x 6W max	44		✓	✓
TRIPLE ROUND	1393005	1393002		GU10 LED▼	3 x 6W max	44		✓	✓
RECESSED	1393008	1393007		GU10 LED▼	6W max	44		✓	✓



AQUA SINGLE

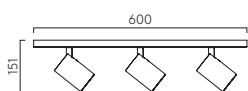

AQUA TRIPLE BAR

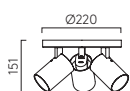

AQUA TRIPLE ROUND



AQUA RECESSED

▼ Lamp excluded, see page 714 / La lampe exclu, voir page 714 / La lampadina esclusi a pagina 714 / Das Leuchtmittel ist ausgeschlossen, sie auf Seite 714.





COMO

ZONES 2 3

		LAMP	WATT	IP	CLASS			
SINGLE	1282001	GU10 LED▼	6W max	44		✓	-	✓
TWIN	1282005	GU10 LED▼	2 x 6W max	44		-	✓	✓
TRIPLE ROUND	1282002	GU10 LED▼	3 x 6W max	44		✓	-	✓
TRIPLE BAR	1282003	GU10 LED▼	3 x 6W max	44		✓	-	✓



COMO SINGLE



COMO TWIN



COMO TRIPLE ROUND

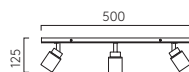

COMO TRIPLE BAR

COMO TWIN: Removable pull-cord switch / Tirette amovibile / Zugschalter entfernbar / Interruttore con filo a tirante rimovibile.

▼ Lamp excluded, see page 714 / La lampe exclu, voir page 714 / La lampadina esclusi a pagina 714 / Das Leuchtmittel ist ausgeschlossen, sie auf Seite 714.