

astro

2020/21

LIGHTING
CATALOGUE

FOLD COLLECTION

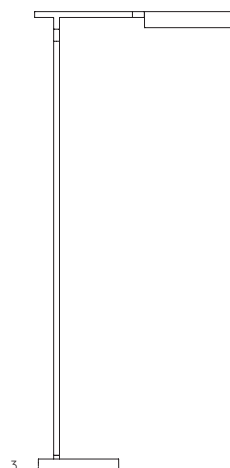
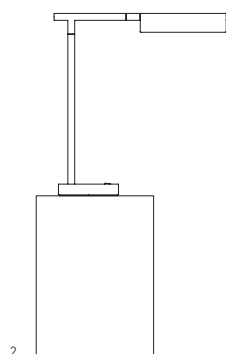
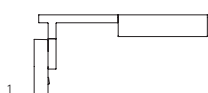

- 1. WALL [P. 307](#)
- 2. TABLE [P. 409](#)
- 3. FLOOR [P. 411](#)



ASCOLI COLLECTION

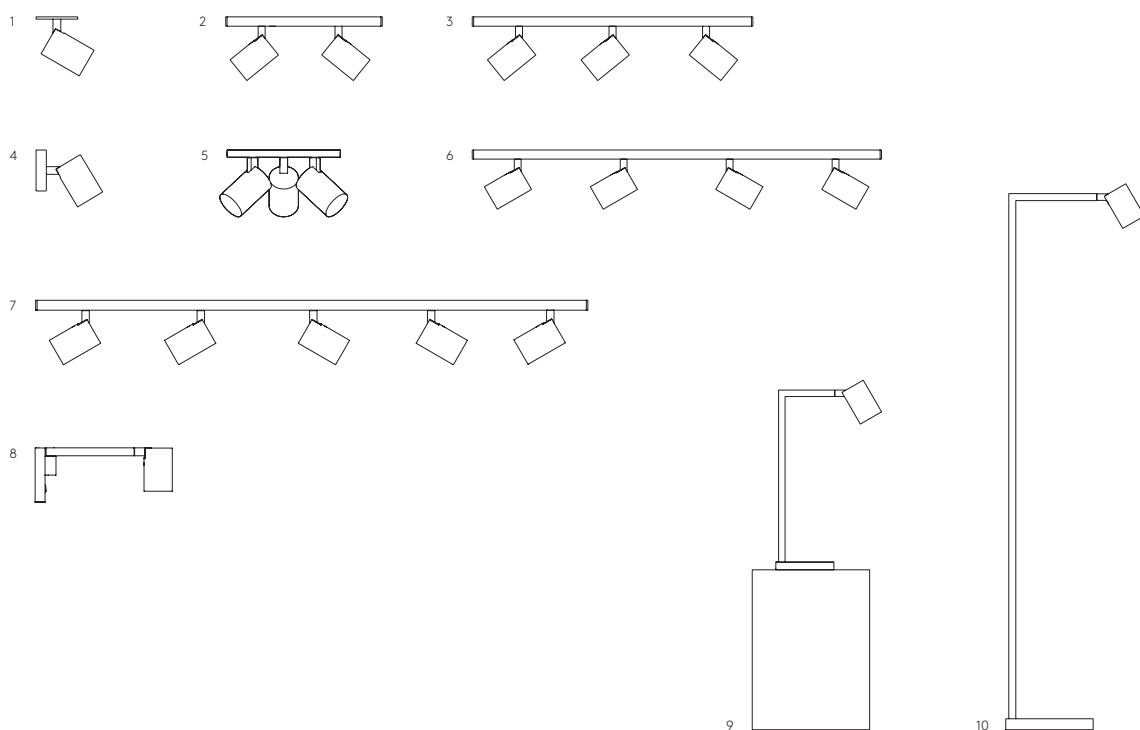

- | | |
|--------------------|--------|
| 1. RECESSED | P. 555 |
| 2. TWIN | P. 555 |
| 3. TRIPLE BAR | P. 555 |
| 4. SINGLE/SWITCHED | P. 555 |
| 5. TRIPLE ROUND | P. 555 |
| 6. FOUR BAR | P. 555 |
| 7. FIVE BAR | P. 555 |
| 8. SWING | P. 309 |
| 9. DESK | P. 413 |
| 10. FLOOR | P. 415 |



ENNA COLLECTION

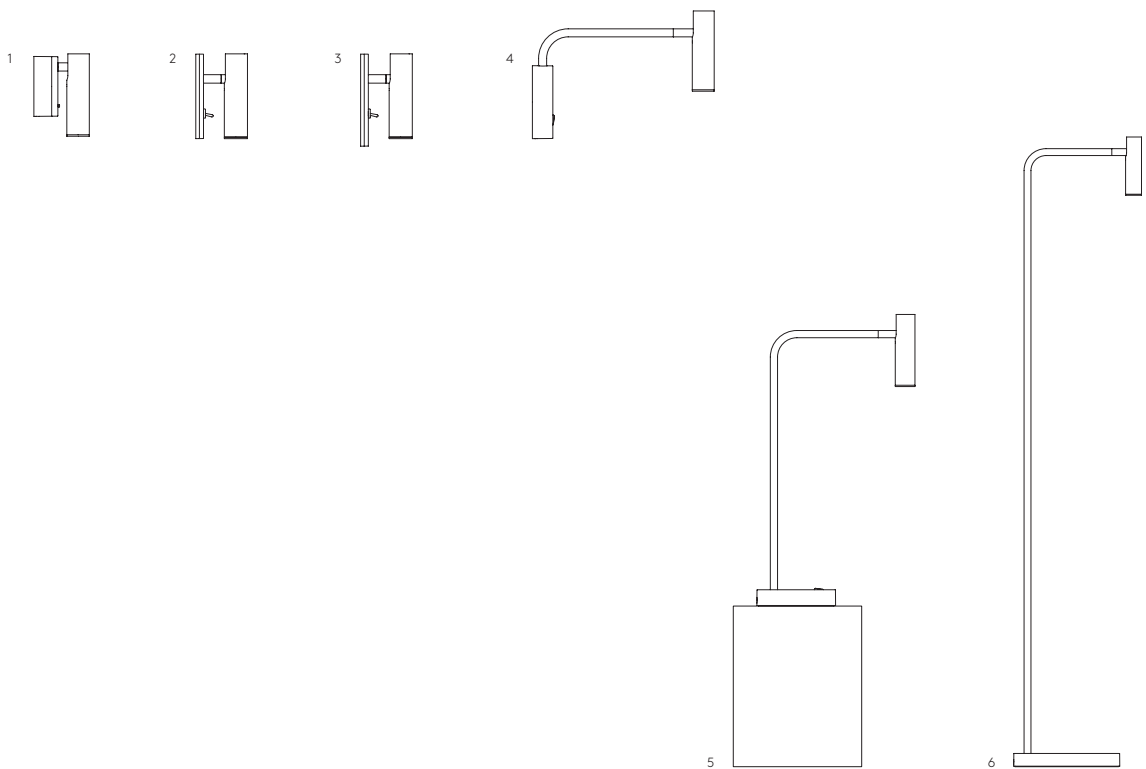

- | | |
|--------------------|--------|
| 1. SURFACE | P. 315 |
| 2. RECESS SWITCHED | P. 317 |
| 3. SQUARE SWITCHED | P. 313 |
| 4. WALL | P. 311 |
| 5. DESK | P. 417 |
| 6. FLOOR | P. 419 |



ATELIER COLLECTION

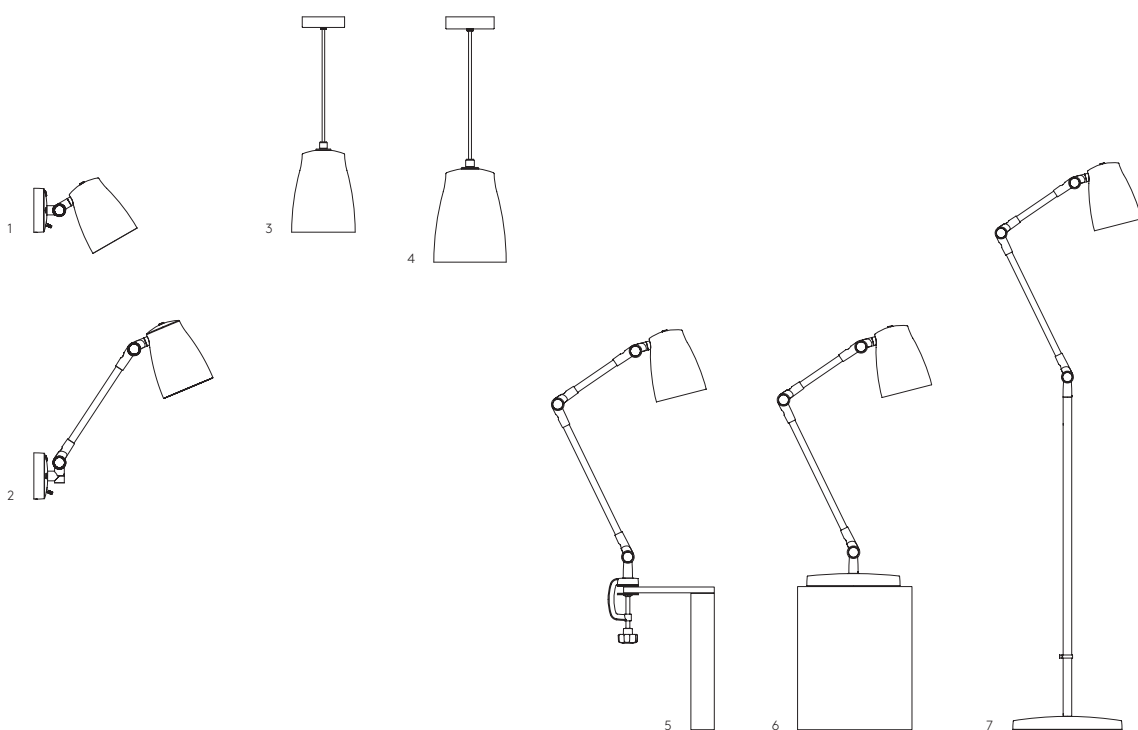

- | | |
|----------------|--------|
| 1. WALL | P. 283 |
| 2. GRANDE WALL | P. 285 |
| 3. PENDANT 150 | P. 497 |
| 4. PENDANT 200 | P. 497 |
| 5. CLAMP | P. 421 |
| 6. DESK | P. 421 |
| 7. FLOOR | P. 423 |



JOEL COLLECTION

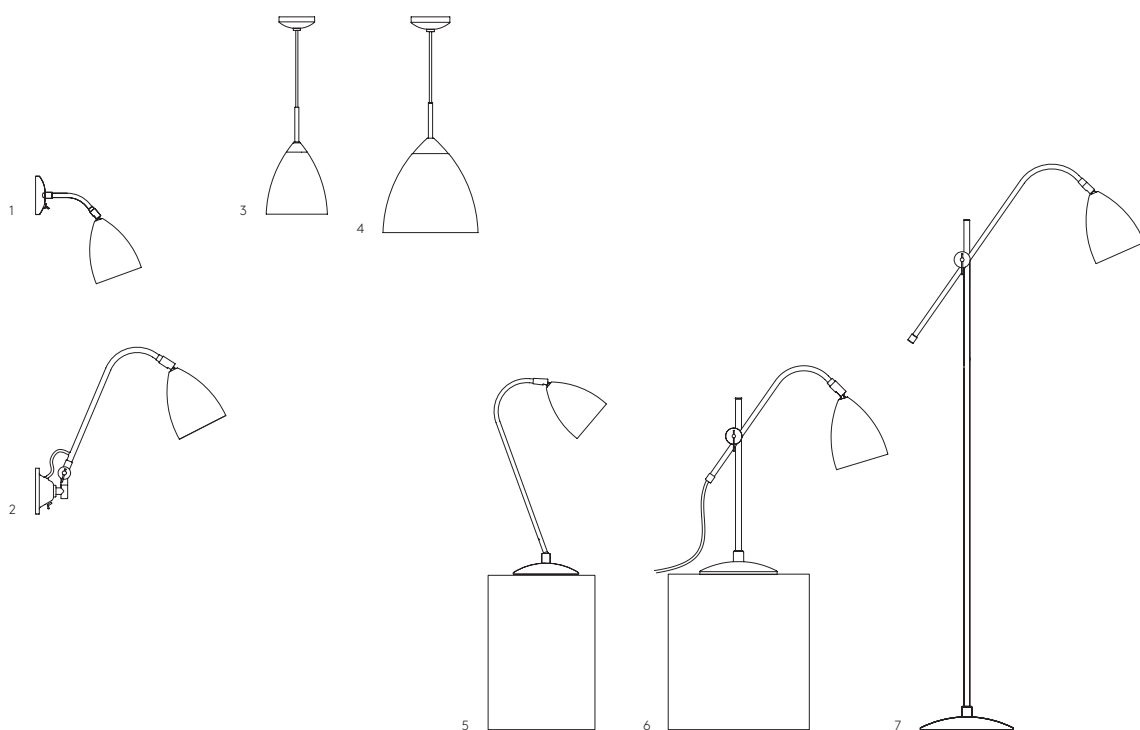

- | | |
|-----------------|--------|
| 1. WALL | P. 287 |
| 2. GRANDE WALL | P. 289 |
| 3. PENDANT 170 | P. 499 |
| 4. PENDANT 270 | P. 499 |
| 5. TABLE | P. 424 |
| 6. GRANDE TABLE | P. 425 |
| 7. FLOOR | P. 427 |



TELEGRAPH COLLECTION

GB The products on these pages are sold without shade to enable the user to mix and match the shades and bases.

FR Les luminaires décrits dans ces pages sont vendus sans abat-jour. Ceci permet d'assortir et de combiner luminaire et abat-jour.

DE Die Produkte auf diesen Seiten werden ohne Schirme geliefert, so dass Schirme und Leuchten nach Belieben kombiniert werden können.

IT I prodotti illustrati nelle presenti pagine sono venduti privi di paralume, per consentire al cliente di abbinare il corpo con il paralume della tonalità preferita.

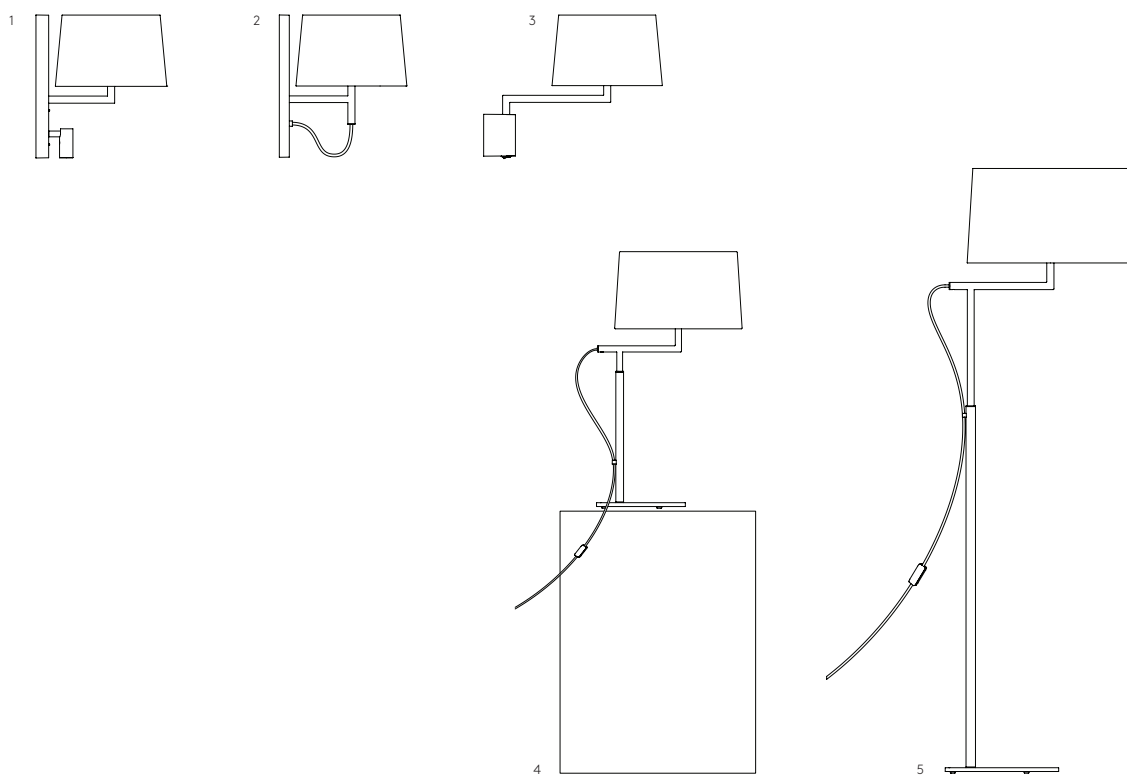

- 1. READER P. 295
- 2. WALL P. 251
- 3. SWING P. 253
- 4. TABLE P. 429
- 5. FLOOR P. 429



RAVELLO COLLECTION

GB The products on these pages are sold without shade to enable the user to mix and match the shades and bases.

FR Les luminaires décrits dans ces pages sont vendus sans abat-jour. Ceci permet d'assortir et de combiner luminaire et abat-jour.

DE Die Produkte auf diesen Seiten werden ohne Schirme geliefert, so dass Schirme und Leuchten nach Belieben kombiniert werden können.

IT I prodotti illustrati nelle presenti pagine sono venduti privi di paralume, per consentire al cliente di abbinare il corpo con il paralume della tonalità preferita.

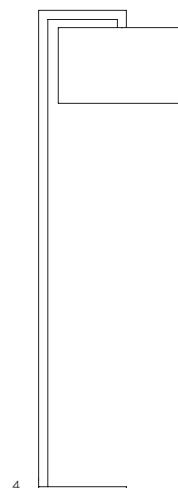
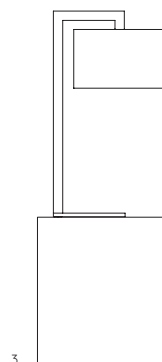
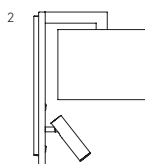
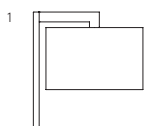

- 1. WALL P. 247
- 2. LED READER P. 301
- 3. TABLE P. 431
- 4. FLOOR P. 433



AZUMI COLLECTION

GB The products on these pages are sold without shade to enable the user to mix and match the shades and bases.

FR Les luminaires décrits dans ces pages sont vendus sans abat-jour. Ceci permet d'assortir et de combiner luminaire et abat-jour.

DE Die Produkte auf diesen Seiten werden ohne Schirme geliefert, so dass Schirme und Leuchten nach Belieben kombiniert werden können.

IT I prodotti illustrati nelle presenti pagine sono venduti privi di paralume, per consentire al cliente di abbinare il corpo con il paralume della tonalità preferita.

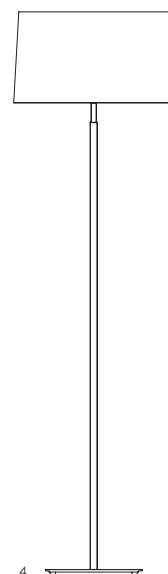
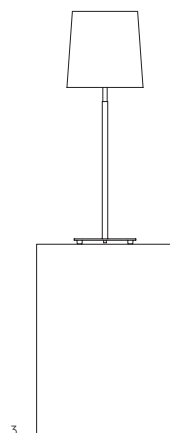
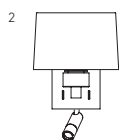
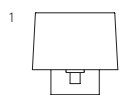

- 1. CLASSIC P. 249
- 2. READER P. 303
- 3. TABLE P. 434
- 4. FLOOR P. 435

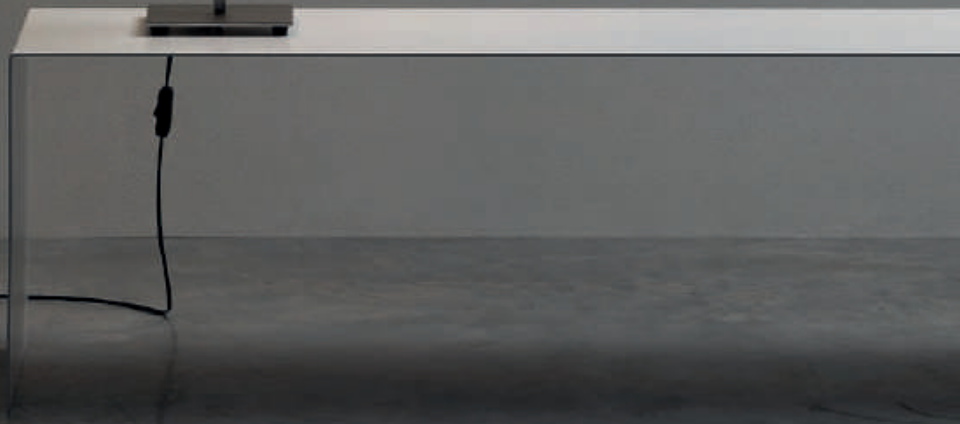

PARK LANE COLLECTION

GB The products on these pages are sold without shade to enable the user to mix and match the shades and bases.

FR Les luminaires décrits dans ces pages sont vendus sans abat-jour. Ceci permet d'assortir et de combiner luminaire et abat-jour.

DE Die Produkte auf diesen Seiten werden ohne Schirme geliefert, so dass Schirme und Leuchten nach Belieben kombiniert werden können.

IT I prodotti illustrati nelle presenti pagine sono venduti privi di paralume, per consentire al cliente di abbinare il corpo con il paralume della tonalità preferita.

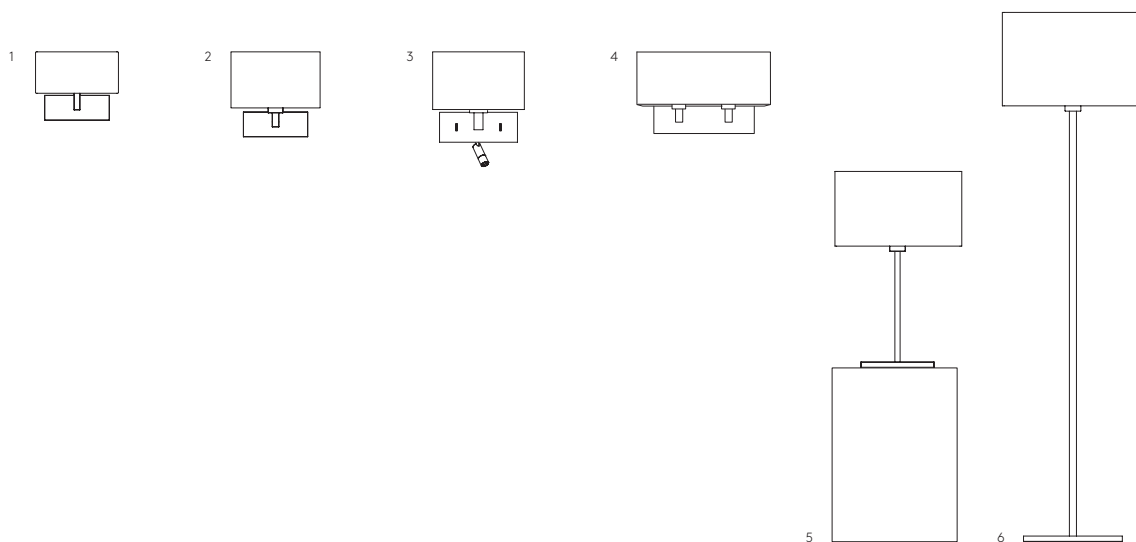

- 1. PARK LANE P. 241
- 2. GRANDE P. 243
- 3. READER P. 305
- 4. TWIN P. 245
- 5. TABLE P. 436
- 6. FLOOR P. 437





WALL

APPLIQUES MURALES · WANDLEUCHTEN · LAMPADE DA PARETE



CARME
P. 217



LIMA
P. 219



CASERTA
P. 221



VALBONNE
P. 223



BEAUVILLE
P. 225



GAUDI
P. 227



TATE
P. 229



MONTCLAIR TWIN
P. 230



DELPHI SINGLE
P. 231



RIVA 350
P. 233



LAGO 280
P. 235



NAPOLI
P. 237



CONNAUGHT
P. 239



PARK LANE
P. 241



PARK LANE GRANDE
P. 243



PARK LANE TWIN
P. 245



RAVELLO WALL
P. 247



AZUMI CLASSIC
P. 249



TELEGRAPH WALL
P. 251



TELEGRAPH SWING
P. 253



SAN MARINO SOLO
P. 255



MITSU WALL
P. 257



MITSU SWING ARM
P. 259



CHUO
P. 261



PETRA 180
P. 263



IOS 250
P. 264



ASHINO
P. 265



CREMONA
P. 267



KINZO LED
P. 269



YUMA LED
P. 271



JURA
P. 273



NEW
io WALL
P. 275



HARVARD WALL
P. 277



BOSTON
P. 279



VERSAILLES
P. 281



ATELIER WALL
P. 283



ATELIER
GRANDE WALL
P. 285



JOEL WALL
P. 287



JOEL GRANDE WALL
P. 289



SIDE BY SIDE
P. 293



TELEGRAPH
READER
P. 295



NAPOLI
READER
P. 297



NAPOLI LED
P. 299



RAVELLO
P. 301



AZUMI READER
P. 303



PARK LANE READER
P. 305



NEW
FOLD WALL
P. 307



ASCOLI SWING
P. 309



ENNA WALL
P. 311



ENNA SQUARE
P. 313



ENNA SURFACE
P. 315



ENNA RECESS
P. 317



MICRO RECESS
P. 319



NEW
FUSE/USB
P. 321



DIGIT
P. 323



TOSCA
P. 325



LEO SWITCHED
P. 327



FOSSO
P. 329



LINDOS
P. 331



EDGE READER MINI
P. 335



EDGE READER
P. 335



NEW
VELO
P. 341



NEW
SHADOW
P. 345



PARMA 100/110
P. 345



PARMA 160/210
P. 347



PARMA 250/625
P. 349



RIO
P. 351



PELLA
P. 353



PIENZA
P. 355



KOZA
P. 357



KYMI
P. 359



PERO
P. 361



MOSTO
P. 361



BRENTA
P. 363



S-LIGHT
P. 364



BOLOGNA 240
P. 365



SERIFOS
P. 367



● ECLIPSE ROUND
P. 369



● ECLIPSE SQUARE
P. 369



ARIA
P. 371



KYO
P. 373



GOSFORD
P. 375



MILO
P. 377



AMALFI
P. 379



● EDGE
P. 381



CYL
P. 383



LUGA
P. 385



OBROUND
P. 385



TOKYO
P. 387



● RENOIR
P. 389



● MONDRIAN FRAME
P. 391



● MONDRIAN
P. 393



● GOYA
P. 395



● LEROS TRIMLESS
P. 399



● OLYMPUS TRIMLESS
P. 399



● BORG0 TRIMLESS
P. 401



● BORG0 TRIMLESS
P. 401



● **NEW**
BORG0/MV
P. 403



● **NEW**
BORG0/MV
P. 403



● TANGO
P. 405





CARMEL (1405001 + 5013001)



CARMEL GRANDE (1405004 + 5001003)



CARMEL

SHADE EXCLUDED

| | | | LAMP | WATT | CLASS | |
|---------------|---------|---------|-----------|---------|-------|---|
| CARMEL | 1405001 | 1405002 | E14 LED ▼ | 7W max | | ✓ |
| GRANDE | 1405003 | 1405004 | E27 LED ▼ | 12W max | | ✓ |

CARMEL

CARMEL GRANDE

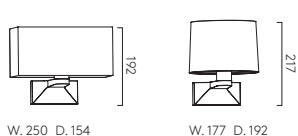

RECTANGLE 250

- 5001005
- 5001006
- 5001013
-
-

TAPERED DRUM 177

- 5013001
- 5013002
- 5013003
- 5013006
-

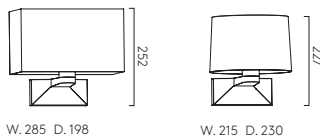

RECTANGLE 285

- 5001001
- 5001003
- 5001007
- 5001017
- 5011009

TAPERED ROUND 215

- 5006001
- 5006002
- 5006003
- 5006004
- 5035011

P. 716: Special Shade Colours / Couleurs spéciales / Sonderfarben / Colori speciali

▼ Lamp excluded, see page 714 / La lampe exclu, voir page 714 / La lampadina esclusi a pagina 714 / Das Leuchtmittel ist ausgeschlossen, sie auf Seite 714.





LIMA (1318001 + 5026001)



LIMA (1318009 + 5026003)



LIMA

SHADE EXCLUDED

| | PCh | MN | Br | LAMP | WATT | CLASS | |
|--|---------|---------|---------|-----------|---------|-------|---|
| | 1318001 | 1318002 | 1318009 | E27 LED ▼ | 12W max | | ✓ |

SEMI DRUM 320

W. 325 D. 130

- WF 5026001
- BF 5026002
- OF 5026003
- PF 5026005
- MF 5029007

P. 716: Special Shade Colours
Couleurs spéciales / Sonderfarben /
Colori speciali

▼ Lamp excluded, see page 714 / La lampe exclu, voir
page 714 / La lampadina esclusi a pagina 714 / Das
Leuchtmittel ist ausgeschlossen, sie auf Seite 714.





CASERTA (1349010 + 5026003)



CASERTA (1349001 + 5026002)



CASERTA

SHADE EXCLUDED

| | LAMP | WATT | CLASS | |
|---|-----------|---------|-------|---|
| <p>PCh 1349001 MN 1349002 Br 1349010 MG 1349005</p> | E27 LED ▼ | 12W max | | ✓ |

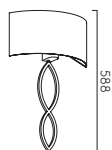

W. 320 D. 128

SEMI DRUM 320

- WF 5026001
- BF 5026002
- OF 5026003
- PF 5026005
- MF 5290087

P. 716: Special Shade Colours
Couleurs spéciales / Sonderfarben /
Colori speciali

▼ Lamp excluded, see page 714 / La lampe exclu, voir
page 714 / La lampadina esclusi a pagina 714 / Das
Leuchtmittel ist ausgeschlossen, sie auf Seite 714.





VALBONNE (1356001 + 5029003)



VALBONNE (1356007 + 5029002)

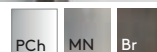

VALBONNE

SHADE EXCLUDED

| | LAMP | WATT | CLASS | |
|--|-----------|---------|-------|---|
| PCh 1356001 MN 1356003 Br 1356007 | E27 LED ▼ | 12W max | | ✓ |

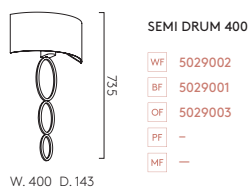

W. 400 D. 143

P. 716: Special Shade Colours
Couleurs spéciales / Sonderfarben /
Colori speciali

▼ Lamp excluded, see page 714 / La lampe exclu, voir
page 714 / La lampadina esclusi a pagina 714 / Das
Leuchtmittel ist ausgeschlossen, sie auf Seite 714.





BEAUVILLE (1388001 + 5033003)



BEAUVILLE (1388001 + 5033002)

PCh Br

BEAUVILLE

SHADE EXCLUDED

| | LAMP | WATT | CLASS | |
|------------------------|-----------|---------|-------|---|
| PCh 1388001 Br 1388003 | E27 LED ▼ | 12W max | | ✓ |

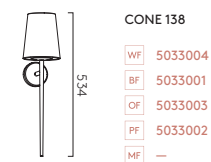

W. 138 D. 162

P. 716: Special Shade Colours
Couleurs spéciales / Sonderfarben /
Colori speciali

▼ Lamp excluded, see page 714 / La lampe exclu, voir
page 714 / La lampadina esclusi a pagina 714 / Das
Leuchtmittel ist ausgeschlossen, sie auf Seite 714.





GAUDI (1385003 + 5026002)



GAUDI (1385002 + 5026003)

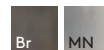

GAUDI

SHADE EXCLUDED

| | LAMP | WATT | CLASS | |
|---|-----------|---------|-------|---|
| Br 1385003 MN 1385002 | E27 LED ▼ | 12W max | | ✓ |

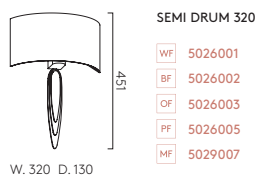

P. 716: Special Shade Colours
Couleurs spéciales / Sonderfarben /
Colori speciali

▼ Lamp excluded, see page 714 / La lampe exclu, voir
page 714 / La lampadina esclusi a pagina 714 / Das
Leuchtmittel ist ausgeschlossen, sie auf Seite 714.





TATE (1334003 + 5026002)



TATE (1334007 + 5026003)

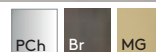

TATE

SHADE EXCLUDED

| | LAMP | WATT | CLASS | |
|--|----------|---------|-------|---|
| PCh 1334002 Br 1334007 MG 1334003 | E27 LED▼ | 12W max | | ✓ |

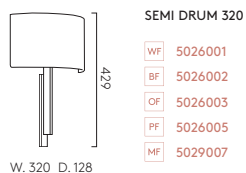

P. 716: Special Shade Colours
Couleurs spéciales / Sonderfarben /
Colori speciali

▼ Lamp excluded, see page 714 / La lampe exclu, voir
page 714 / La lampadina esclusi a pagina 714 / Das
Leuchtmittel ist ausgeschlossen, sie auf Seite 714.

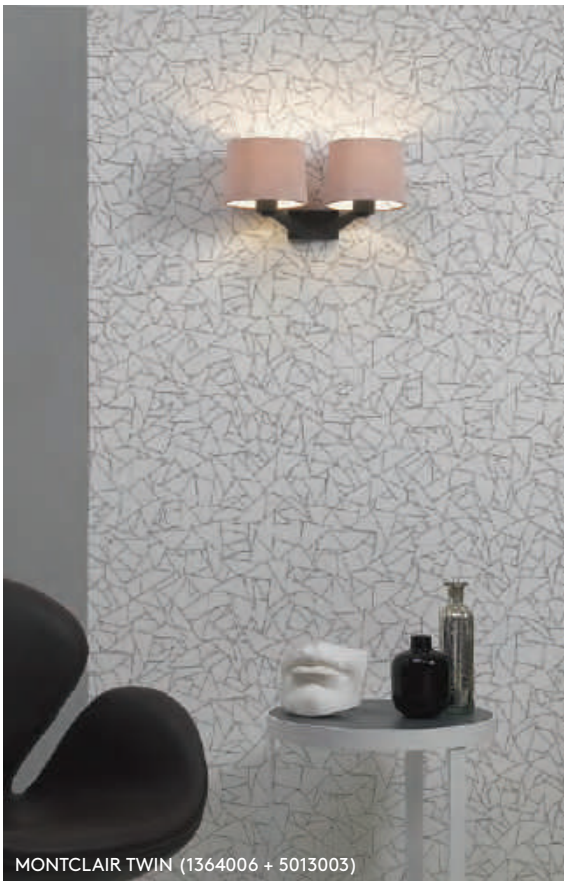

MONTCLAIR TWIN (1364006 + 5013003)



MONTCLAIR TWIN (1364005 + 5013002)

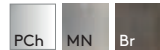

MONTCLAIR TWIN

SHADE EXCLUDED

| | LAMP | WATT | CLASS | |
|-------------|-----------|-------------|-------|---|
| PCh 1364004 | E27 LED ▼ | 2 x 12W max | | ✓ |

TAPERED DRUM 177

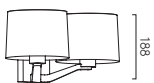

W. 382 D. 209

| | |
|----|---------|
| WF | 5013001 |
| BF | 5013002 |
| OF | 5013003 |
| PF | 5013006 |
| MF | — |

P. 716: Special Shade Colours
Couleurs spéciales / Sonderfarben /
Colori speciali

▼ Lamp excluded, see page 714 / La lampe exclu, voir
page 714 / La lampadina esclusi a pagina 714 / Das
Leuchtmittel ist ausgeschlossen, sie auf Seite 714.



DELPHI SINGLE (1313002 + 5018011)



DELPHI SINGLE (1313002 + 5018012)



DELPHI SINGLE

SHADE EXCLUDED

| | LAMP | WATT | CLASS | | |
|--------------------|-----------|---------|-------|---|---|
| PCh 1313002 | E27 LED ▼ | 12W max | | ✓ | ✓ |

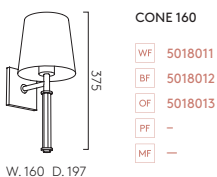

- WF 5018011
- BF 5018012
- OF 5018013
- PF -
- MF -

P. 716: Special Shade Colours
Couleurs spéciales / Sonderfarben /
Colori speciali

▼ Lamp excluded, see page 714 / La lampe exclu, voir
page 714 / La lampadina esclusi a pagina 714 / Das
Leuchtmittel ist ausgeschlossen, sie auf Seite 714.





RIVA 350 (1214008 + 5018004)



RIVA 350 (1214010 + 5018014)



RIVA 350

SHADE EXCLUDED

| | LAMP | WATT | CLASS | | | | | |
|--------------------|-------------------|-------------------|-------------------|-----------|---------|--|---|---|
| PCh 1214001 | MN 1214004 | Br 1214010 | MG 1214008 | E27 LED ▼ | 12W max | | ✓ | ✓ |

CONE 240

W. 140 D. 162

- WG** 5018007
- WP** 5018004
- BF** 5018015
- OF** -
- PF** 5018014
- MF** -

P. 716: Special Shade Colours
Couleurs spéciales / Sonderfarben /
Colori speciali

▼ Lamp excluded, see page 714 / La lampe exclu, voir
page 714 / La lampadina esclusi a pagina 714 / Das
Leuchtmittel ist ausgeschlossen, sie auf Seite 714.





LAGO 280 (1297002 + 5018001)



LAGO 280 (1297001 + 5019001)



LAGO 280

SHADE EXCLUDED

| | LAMP | WATT | IP | CLASS | | |
|--|----------|---------|----|-------|---|---|
| PCh 1297001 MN 1297002 Br 1297007 | E27 LED▼ | 12W max | 44 | | ✓ | ✓ |

CONE 195

| | |
|-----------------|---------|
| WG | 5019001 |
| WF | 5018001 |
| BF | - |
| OF | - |
| PF | - |
| MF | - |

W. 113 D. 135

P. 716: Special Shade Colours
Couleurs spéciales / Sonderfarben /
Colori speciali

▼ Lamp excluded, see page 714 / La lampe exclu, voir
page 714 / La lampadina esclusi a pagina 714 / Das
Leuchtmittel ist ausgeschlossen, sie auf Seite 714.





NAPOLI (1185001 + 5014001)



NAPOLI (1185001 + 5014003)

MN

NAPOLI

SHADE EXCLUDED

| | LAMP | WATT | CLASS | |
|---------|-----------|---------|-------|---|
| 1185001 | E27 LED ▼ | 12W max | | ✓ |

OVAL 285



W. 285 D. 160

- 5014001
- 5014002
- 5014003
- 5014004
- 5014016

P. 716: Special Shade Colours
Couleurs spéciales / Sonderfarben /
Colori speciali

▼ Lamp excluded, see page 714 / La lampe exclu, voir
page 714 / La lampadina esclusi a pagina 714 / Das
Leuchtmittel ist ausgeschlossen, sie auf Seite 714.





CONNAUGHT + BLACK SHADE (1099003)



CONNAUGHT + WHITE SHADE (1099004)



CONNAUGHT

| | | LAMP | WATT | CLASS | |
|-------------|---------|-----------|--------|-------|---|
| WHITE SHADE | 1099004 | E14 LED ▼ | 7W max | | ✓ |
| BLACK SHADE | 1099003 | E14 LED ▼ | 7W max | | ✓ |



W. 180 D. 140

CONNAUGHT

▼ Lamp excluded, see page 714 / La lampe exclu, voir page 714 / La lampadina esclusi a pagina 714 / Das Leuchtmittel ist ausgeschlossen, sie auf Seite 714.





PARK LANE + BLACK SHADE (1080002)



PARK LANE

| | PCh | MN | Br | LAMP | WATT | CLASS | 🔌 |
|--------------------|---------|---------|---------|----------|--------|-------|---|
| WHITE SHADE | 1080011 | 1080009 | 1080044 | E14 LED▼ | 7W max | 🔌 | ✓ |
| BLACK SHADE | 1080002 | 1080022 | | E14 LED▼ | 7W max | 🔌 | ✓ |



W. 250 D. 141

PARK LANE

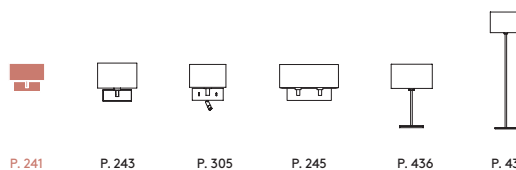

Oyster coloured shades (ref: 5001013) available to order separately. / Les abat-jours couleur coquille d'huître (ref: 5001013) peuvent être commandées séparément. / Schirme in der Farbe Oyster (Art. Nr.: 5001013) können separat bestellt werden. / Sono disponibili paralumi di colore 'oyster' (ref: 5001013), da ordinare separatamente.

▼ Lamp excluded, see page 714 / La lampe exclu, voir page 714 / La lampadina esclusi a pagina 714 / Das Leuchtmittel ist ausgeschlossen, sie auf Seite 714.





PARK LANE GRANDE (1080004 + 5034003)



PARK LANE GRANDE (1080007 + 5034004)



PARK LANE GRANDE

SHADE EXCLUDED

| | LAMP | WATT | CLASS | |
|--|-----------|---------|-------|---|
| PCh 1080004 MN 1080007 Br 1080045 | E27 LED ▼ | 12W max | | ✓ |

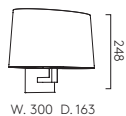
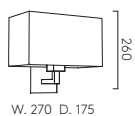

RECTANGLE 285

- WF 5001001
- BF 5001003
- OF 5001007
- PF 5001017
- MF 5011009

TAPERED OVAL*

- WF 5034001
- BF 5034002
- OF 5034003
- PF 5034004
- MF -

P. 716: Special Shade Colours / Couleurs spéciales / Sonderfarben / Colori speciali

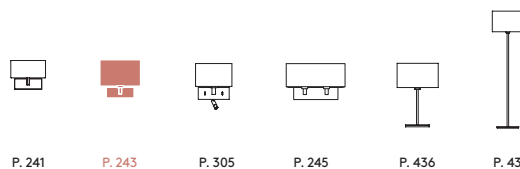

* To be used with LED/CFL lamp only / Pour utilisation avec lampe LED/CFL seulement. / nur mit Kompaktleuchtstofflampe / LED verwenden / Solo per l'uso con lampade a LED/CFL.

▼ Lamp excluded, see page 714 / La lampe exclu, voir page 714 / La lampadina esclusi a pagina 714 / Das Leuchtmittel ist ausgeschlossen, sie auf Seite 714.

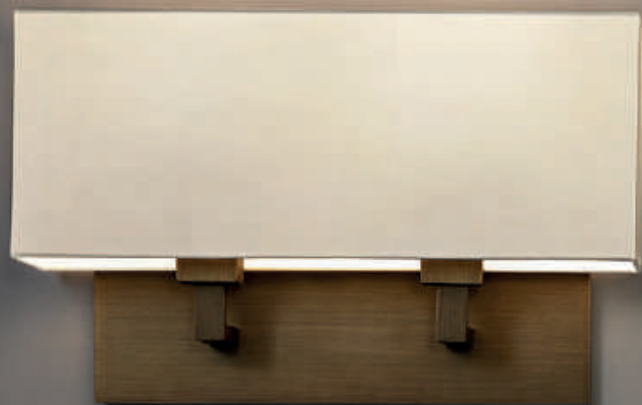



PARK LANE TWIN (1080020 + 5001016)

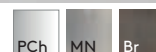

PARK LANE TWIN

SHADE EXCLUDED

| | LAMP | WATT | CLASS | |
|--------------------|------------------|-------------|-------|---|
| PCh 1080019 | E27 LED ▼ | 2 x 12W max | | ✓ |

MN 1080020 **Br** 1080048

PARK LANE TWIN SHADE

| | |
|----|---------|
| WF | 5001014 |
| BF | 5001015 |
| OF | 5001016 |
| PF | 5001029 |
| MF | - |

W. 445 D. 177

P. 716: Special Shade Colours
Couleurs spéciales / Sonderfarben / Colori speciali

| | | | | | |
|--------|--------|--------|--------|--------|--------|
| | | | | | |
| P. 241 | P. 243 | P. 305 | P. 245 | P. 436 | P. 437 |

▼ Lamp excluded, see page 714 / La lampe exclu, voir page 714 / La lampadina esclusi a pagina 714 / Das Leuchtmittel ist ausgeschlossen, sie auf Seite 714.





RAVELLO WALL (1222012 + 5015007)



RAVELLO WALL (1222040 + 5016009)

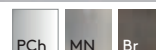

RAVELLO WALL

SHADE EXCLUDED

LAMP WATT CLASS

PCh 1222012 **MN** 1222013 **Br** 1222040

E27 LED ▾ 12W max

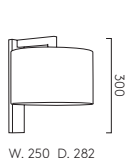

DRUM 250

- WF** 5016007
- BF** 5016008
- OF** 5016009
- PF** 5016019
- MF** 5016078

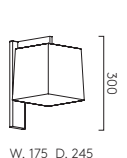

RAVELLO TAPERED SQUARE 175

- WF** 5030004
- BF** 5030003
- OF** 5030005
- PF** 5030006
- MF** -

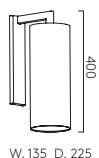

TUBE 135

- WF** 5015004
- BF** 5015005
- OF** 5015006
- PF** 5015007
- MF** -

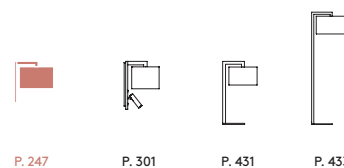

P. 716: Special Shade Colours
Couleurs spéciales / Sonderfarben / Colori speciali

▾ Lamp excluded, see page 714 / La lampe exclu, voir page 714 / La lampadina esclusi a pagina 714 / Das Leuchtmittel ist ausgeschlossen, sie auf Seite 714.





AZUMI CLASSIC (1142044 + 5006001)



AZUMI CLASSIC

SHADE EXCLUDED

LAMP WATT CLASS

Br 1142044 PN 1142016 MN 1142017

E27 LED 12W max

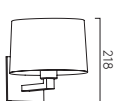

W. 215 D. 247

TAPERED ROUND 215

- 5006001
- 5006002
- 5006003
- 5006004
- 5035011

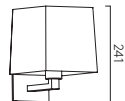

W. 175 D. 223

TAPERED SQUARE 175

- 5005001
- 5005002
- 5005003
- 5005004
-

P. 716: Special Shade Colours
Couleurs spéciales / Sonderfarben / Colori speciali

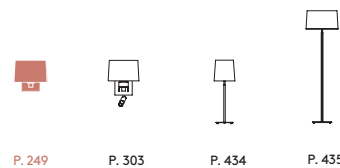

▼ Lamp excluded, see page 714 / La lampe exclu, voir page 714 / La lampadina esclusi a pagina 714 / Das Leuchtmittel ist ausgeschlossen, sie auf Seite 714.





TELEGRAPH WALL (1404010)



TELEGRAPH WALL (1404011)



TELEGRAPH WALL

SHADE EXCLUDED

| | LAMP | WATT | CLASS | |
|---|---------|---------|-------|-------------------------------------|
| MB 1404010 MN 1404011 Br 1404012 | E27 LED | 12W max | | <input checked="" type="checkbox"/> |

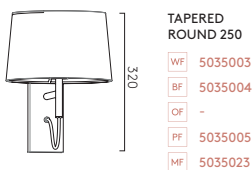

P. 716: Special Shade Colours
Couleurs spéciales / Sonderfarben / Colori speciali

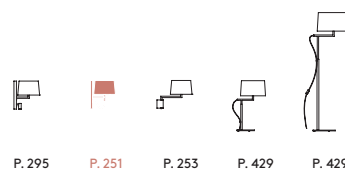

▼ Lamp excluded, see page 714 / La lampe exclu, voir page 714 / La lampadina esclusi a pagina 714 / Das Leuchtmittel ist ausgeschlossen, sie auf Seite 714.





TELEGRAPH SWING (1404001 + 5035005)



TELEGRAPH SWING (1404002 + 5035004)

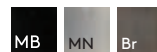

TELEGRAPH SWING

SHADE EXCLUDED

| | LAMP | WATT | CLASS | |
|---|-----------|---------|-------|---|
| MB 1404001 MN 1404002 Br 1404003 | E27 LED ▼ | 12W max | | ✓ |

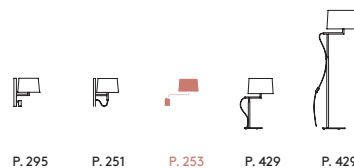
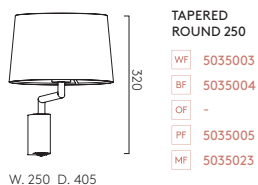

P. 716: Special Shade Colours
Couleurs spéciales / Sonderfarben /
Colori speciali

▼ Lamp excluded, see page 714 / La lampe exclu, voir
page 714 / La lampadina esclusi a pagina 714 / Das
Leuchtmittel ist ausgeschlossen, sie auf Seite 714.





SAN MARINO SOLO (1076005 + 5013001)



SAN MARINO SOLO (1076007 + 5015001)



SAN MARINO SOLO

SHADE EXCLUDED

LAMP WATT CLASS

Br 1076007 PCh 1076005 MN 1076006

G9 LED 3W max



DRUM 150

- WF 5016001
- BF 5016002
- OF 5016003
- PF -
- MF -

TAPERED DRUM 177

- WF 5013001
- BF 5013002
- OF 5013003
- PF 5013006
- MF -

TAPERED DRUM 95

- WF -
- BF 5013004
- OF 5013005
- PF -
- MF -

TUBE 120

- WF 5015001
- BF 5015002
- OF 5015003
- PF -
- MF -

RECTANGLE 285

- WF 5001001
- BF 5001003
- OF 5001007
- PF 5001017
- MF 5011009

P. 716: Special Shade Colours / Couleurs spéciales / Sonderfarben / Colori speciali

▼ Lamp excluded, see page 714 / La lampe exclu, voir page 714 / La lampadina esclusi a pagina 714 / Das Leuchtmittel ist ausgeschlossen, sie auf Seite 714.

LED





MITSU WALL

SHADE EXCLUDED

| MN | Br | LAMP | WATT | CLASS |
|---------|---------|-----------|---------|-------|
| 1394003 | 1394004 | E27 LED ▼ | 12W max | |

CONE 173

W. 173 D. 208

- 5018031
- 5018032
- 5018033
- 5018034
- 5018045

P. 716: Special Shade Colours
Couleurs spéciales / Sonderfarben /
Colori speciali

▼ Lamp excluded, see page 714 / La lampe exclu, voir
page 714 / La lampadina esclusi a pagina 714 / Das
Leuchtmittel ist ausgeschlossen, sie auf Seite 714.





MITSU SWING ARM (1394001 + 5018031)



MITSU SWING ARM (1394002 + 5018033)



MITSU SWING ARM

SHADE EXCLUDED

| | LAMP | WATT | CLASS |
|-----------------------|-----------|---------|-------|
| MN 1394001 Br 1394002 | E27 LED ▼ | 12W max | ⊕ |

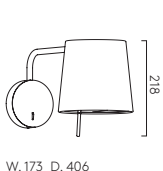

- CONE 173**
- WF 5018031
 - BF 5018032
 - OF 5018033
 - PF 5018034
 - MF 5018045

P. 716: Special Shade Colours
Couleurs spéciales / Sonderfarben /
Colori speciali

▼ Lamp excluded, see page 714 / La lampe exclu, voir
page 714 / La lampadina esclusi a pagina 714 / Das
Leuchtmittel ist ausgeschlossen, sie auf Seite 714.





CHUO SQUARE 250 (5024007 + 1367003)



CHUO RECTANGLE 190 (5024006 + 1367002)



CHUO

| | WF | OF | BACKPLATE EXCL. | LAMP | WATT | CLASS | Ⓢ |
|----------------------|---------|---------|-----------------------|----------|-------------|-------|---|
| RECTANGLE 380 | 5024001 | 5024003 | Backplate 1 - 1367001 | E27 LED▼ | 2 x 12W max | Ⓢ | ✓ |
| SQUARE 250 | 5024007 | 5024009 | Backplate 3 - 1367003 | E27 LED▼ | 12W max | Ⓢ | ✓ |
| RECTANGLE 190 | 5024004 | 5024006 | Backplate 2 - 1367002 | E27 LED▼ | 12W max | Ⓢ | ✓ |

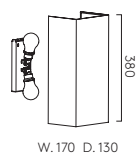

CHUO RECTANGLE 380

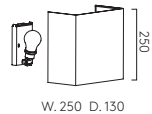

CHUO SQUARE 250

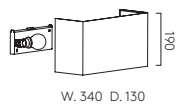

CHUO RECTANGLE 190

● P. 716: Special Shade Colours / Couleurs spéciales / Sonderfarben / Colori speciali

▼ Lamp excluded, see page 714 / La lampe exclu, voir page 714 / La lampadina esclusi a pagina 714 / Das Leuchtmittel ist ausgeschlossen, sie auf Seite 714.





PETRA 180 (5027001 + 1367003)



PETRA 180 (5027003 + 1367003)



PETRA 180

| | BACKPLATE EXCL. | LAMP | WATT | CLASS | |
|------------|-----------------|-----------------------|-----------|---------|-----|
| WF 5027001 | OF 5027003 | Backplate 3 - 1367003 | E27 LED ▼ | 12W max | ⊕ ✓ |

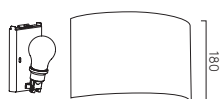

W. 315 D. 120

P. 716: Special Shade Colours
 Couleurs spéciales / Sonderfarben /
 Colori speciali

▼ Lamp excluded, see page 714 / La lampe exclu, voir
 page 714 / La lampadina esclusi a pagina 714 / Das
 Leuchtmittel ist ausgeschlossen, sie auf Seite 714.



IOS 250 (5028001 + 1367003)



IOS 250

| | | BACKPLATE EXCL. | LAMP | WATT | CLASS | |
|-------------------|-------------------|-----------------------|----------|---------|-------|---|
| WF 5028001 | OF 5028003 | Backplate 3 - 1367003 | E27 LED▼ | 12W max | | ✓ |

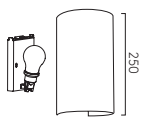

W. 144 D. 120

P. 716: Special Shade Colours
Couleurs spéciales / Sonderfarben /
Colori speciali

▼ Lamp excluded, see page 714 / La lampe exclu, voir page 714 / La lampadina esclusi a pagina 714 / Das Leuchtmittel ist ausgeschlossen, sie auf Seite 714.



ASHINO (1166001)



ASHINO WIDE (1166002)

WF

ASHINO

| | | LAMP | WATT | CLASS | | |
|--------------------|---------|-----------|---------|-------|---|---|
| ASHINO | 1166001 | E14 LED ▼ | 7W max | | ✓ | ✓ |
| ASHINO WIDE | 1166002 | E27 LED ▼ | 12W max | | ✓ | - |

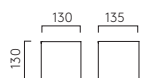

ASHINO

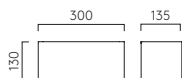

ASHINO WIDE

▼ Lamp excluded, see page 714 / La lampe exclu, voir page 714 / La lampadina esclusi a pagina 714 / Das Leuchtmittel ist ausgeschlossen, sie auf Seite 714.





CREMONA (1067001)



CREMONA

W 1067001

| LAMP | WATT | CLASS | |
|----------|--------|-------|---|
| E14 LED▼ | 7W max | | ✓ |

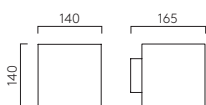

CREMONA

▼ Lamp excluded, see page 714 / La lampe exclu, voir page 714 / La lampadina esclusi a pagina 714 / Das Leuchtmittel ist ausgeschlossen, sie auf Seite 714.

LED





KINZO 110 (1398003)

KINZO 210 (1398006)

KINZO 260 (1398016)



KINZO

| | | | | | LAMP | WATT | INPUT | K | CRI | Lm | CLASS | | |
|------------|------------|------------|------------|------------|--------------|-------|------------|------|-----|---------|-------|-------|---|
| 110 | TB 1398001 | TW 1398002 | MN 1398003 | Br 1398004 | Integral LED | 5.9W | Mains 230V | 2700 | 80 | 167-243 | ⊕ | Phase | ✓ |
| 210 | TB 1398005 | TW 1398006 | MN 1398007 | Br 1398008 | Integral LED | 11.6W | Mains 230V | 2700 | 80 | 322-677 | ⊕ | Phase | ✓ |
| 260 | TB 1398013 | TW 1398014 | MN 1398015 | Br 1398016 | Integral LED | 15.1W | Mains 230V | 2700 | 80 | 449-941 | ⊕ | Phase | ✓ |
| 300 | TB 1398009 | TW 1398010 | MN 1398011 | Br 1398012 | Integral LED | 11.7W | Mains 230V | 2700 | 80 | 186-280 | ⊕ | Phase | ✓ |

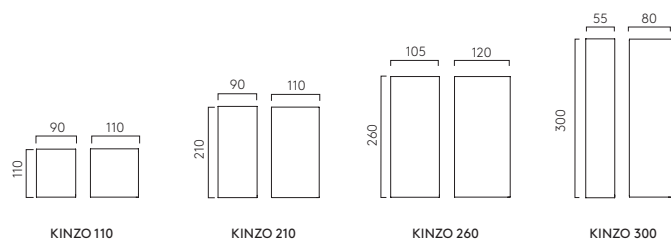

LED





YUMA 120 (1399007)

YUMA 240 (1399009)



YUMA

| | LAMP | WATT | INPUT | K | CRI | Lm | CLASS | | | | | | |
|------------|------------|------------|------------|------------|--------------|-------|------------|------|----|-----|---|-------|---|
| 120 | TW 1399005 | TB 1399006 | MN 1399007 | Br 1399008 | Integral LED | 7.6W | Mains 230V | 2700 | 80 | 435 | ⊕ | Phase | ✓ |
| 240 | TW 1399009 | TB 1399010 | MN 1399011 | Br 1399012 | Integral LED | 15W | Mains 230V | 2700 | 80 | 892 | ⊕ | Phase | ✓ |
| 300 | TW 1399001 | TB 1399002 | MN 1399003 | Br 1399004 | Integral LED | 11.8W | Mains 230V | 2700 | 80 | 388 | ⊕ | Phase | ✓ |

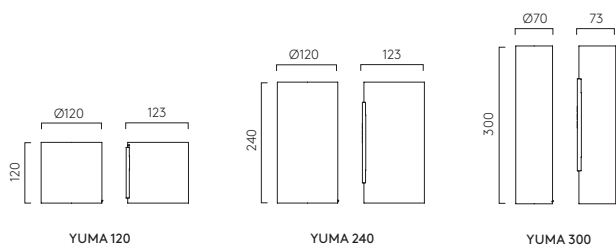

LED





JURA

| | AB | PN | LAMP | WATT | IP | CLASS | ☾ | 💡 |
|---------------|---------|---------|------------|------------|----|-------|---|---|
| SINGLE | 1375001 | 1375005 | GU10 LED ▼ | 6W max | 44 | ⊕ | ✓ | ✓ |
| TWIN | 1375002 | 1375006 | GU10 LED ▼ | 2 x 6W max | 44 | ⊕ | ✓ | ✓ |

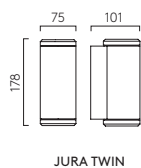
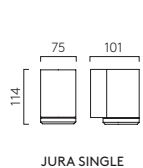

▼ Lamp excluded, see page 714 / La lampe exclu, voir page 714 / La lampadina esclusi a pagina 714 / Das Leuchtmittel ist ausgeschlossen, sie auf Seite 714.



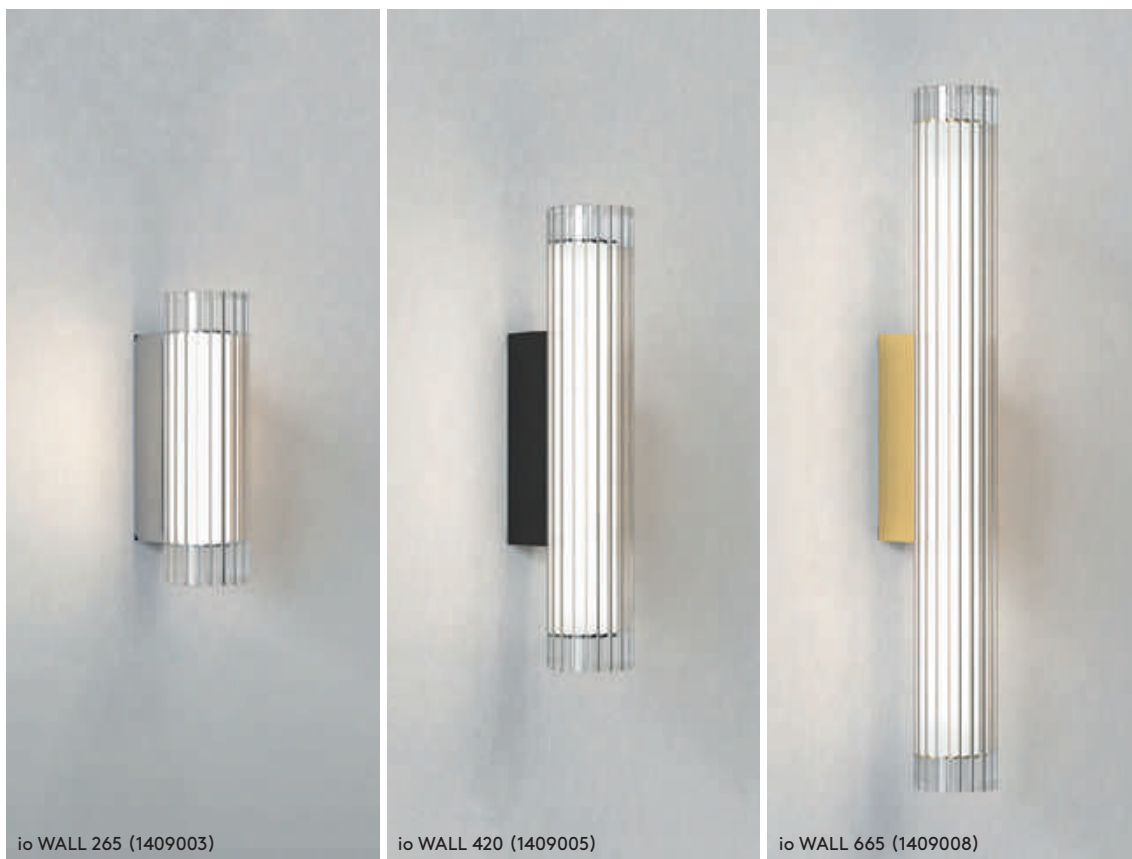

NEW io WALL

| | | | | LAMP | WATT | INPUT | K | CRI | Lm | CLASS | | | |
|------------|----------------|----------------|----------------|--------------|------|------------|------|-----|-----|-------|---|---|---|
| 265 | 1409003 | | | Integral LED | 4.9W | Mains 230V | 3000 | 80 | 403 | | ✓ | ✓ | ✓ |
| 420 | 1409001 | 1409005 | 1409006 | Integral LED | 6.5W | Mains 230V | 3000 | 80 | 605 | | ✓ | ✓ | ✓ |
| 665 | 1409002 | 1409007 | 1409008 | Integral LED | 8.2W | Mains 230V | 3000 | 80 | 825 | | ✓ | ✓ | ✓ |

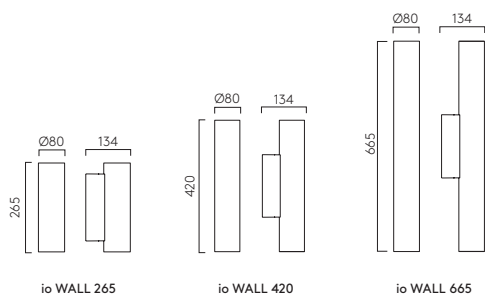





HARVARD WALL (1402007)



HARVARD WALL (1402008)



HARVARD WALL (1402010)



HARVARD WALL

| | LAMP | WATT | CLASS | IP | ☼ | ⚡ |
|--|-----------|--------|-------|----|---|---|
| PSS 1402008 Br 1402009 MB 1402010 NB 1402007 | E27 LED ▼ | 4W max | ⊕ | 44 | ✓ | ✓ |

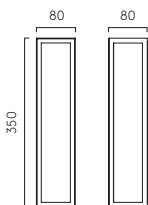

HARVARD WALL

▼ Lamp excluded, see page 714 / La lampe exclu, voir page 714 / La lampadina esclusi a pagina 714 / Das Leuchtmittel ist ausgeschlossen, sie auf Seite 714.

LED





BOSTON 370 (1370002)



BOSTON 600 (1370005)



BOSTON

| | | | LAMP | WATT | INPUT | K | CRI | Lm | CLASS | Ⓢ | Ⓢ |
|------------|--------------------|-------------------|--------------|-------|------------|------|-----|-----|-------|---|---|
| 370 | PCh 1370002 | Br 1370004 | Integral LED | 13.9W | Mains 230V | 3000 | 80 | 465 | □ | ✓ | ✓ |
| 600 | PCh 1370003 | Br 1370005 | Integral LED | 21.9W | Mains 230V | 3000 | 80 | 211 | □ | ✓ | ✓ |

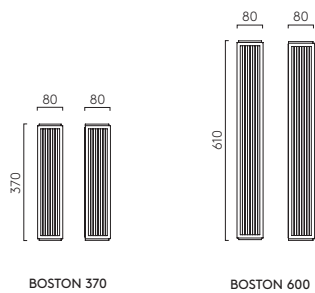

BOSTON 370

BOSTON 600

LED



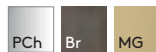
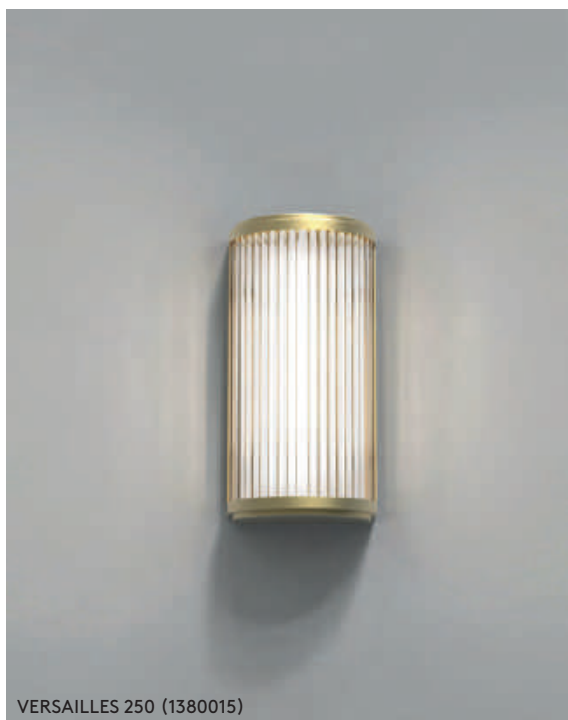

VERSAILLES

| | PCh | Br | MG | LAMP | WATT | INPUT | K | CRI | Lm | IP | CLASS | Ⓧ | 🌐 |
|-----|---------|---------|---------|--------------|-------|------------|------|-----|------|----|-------|---|---|
| 250 | 1380001 | 1380004 | 1380015 | Integral LED | 4.7W | Mains 230V | 3000 | 80 | 371 | 44 | □ | ✓ | ✓ |
| 370 | 1380013 | 1380014 | | Integral LED | 15.1W | Mains 230V | 3000 | 80 | 609 | 44 | □ | ✓ | ✓ |
| 400 | 1380002 | 1380003 | 1380016 | Integral LED | 7.2W | Mains 230V | 3000 | 80 | 650 | 44 | □ | ✓ | ✓ |
| 600 | 1380011 | 1380012 | | Integral LED | 25W | Mains 230V | 3000 | 80 | 1078 | 44 | □ | ✓ | ✓ |

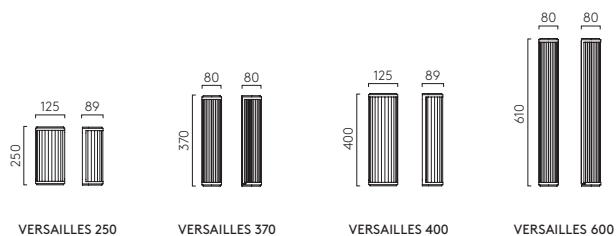





ATELIER WALL (1224011)



ATELIER WALL (1224012)



ATELIER WALL

PA 1224011 MW 1224012 MB 1224013

| LAMP | WATT | CLASS | | |
|-----------|---------|-------|---|---|
| E27 LED ▼ | 12W max | | ✓ | ✓ |

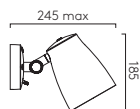

ATELIER WALL

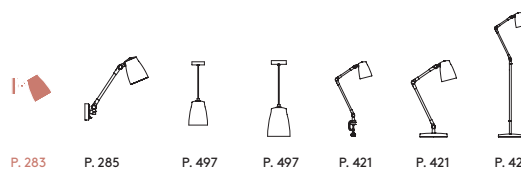

▼ Lamp excluded, see page 714 / La lampe exclu, voir page 714 / La lampadina esclusi a pagina 714 / Das Leuchtmittel ist ausgeschlossen, sie auf Seite 714.





ATELIER GRANDE WALL (1224016)



ATELIER GRANDE WALL (1224014)



ATELIER GRANDE WALL

PA 1224014 MW 1224015 MB 1224016

| LAMP | WATT | CLASS | | |
|----------------------|---------|-------|---|---|
| E27 LED [▼] | 12W max | | ✓ | ✓ |

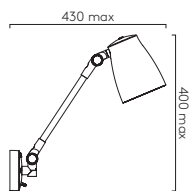

Supplied with removable plug and lead set / Fourni avec prise et cordon amovibles / Inklusive abnehmbarem Stecker und Kabel / Fornito con cavo e spina rimovibile.

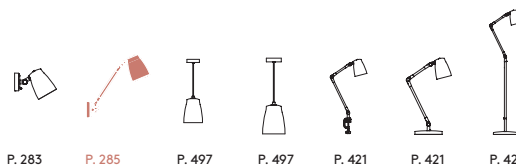

▼ Lamp excluded, see page 714 / La lampe exclu, voir page 714 / La lampadina esclusi a pagina 714 / Das Leuchtmittel ist ausgeschlossen, sie auf Seite 714.





JOEL WALL (1223014)

MB Cr

JOEL WALL

MB 1223014 Cr 1223015

| LAMP | WATT | CLASS | | |
|----------|---------|-------|---|---|
| E27 LED▼ | 12W max | | ✓ | ✓ |

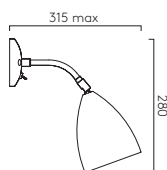

JOEL WALL

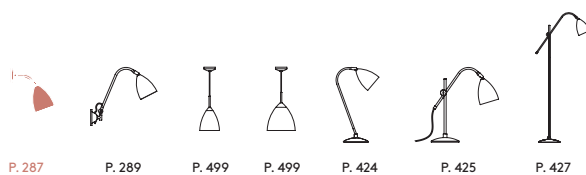

▼ Lamp excluded, see page 714 / La lampe exclu, voir page 714 / La lampadina esclusi a pagina 714 / Das Leuchtmittel ist ausgeschlossen, sie auf Seite 714.





JOEL GRANDE WALL (1223021)

MB Cr

JOEL GRANDE WALL

| | LAMP | WATT | CLASS | |
|------------|-----------|---------|-------|---|
| MB 1223022 | E27 LED ▼ | 12W max | □ | ✓ |

Cr 1223021

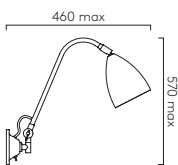

JOEL GRANDE WALL

Supplied with removable plug and lead set. / Fourni avec prise et cordon amovibles. / Inklusive abnehmbarem Stecker und Kabel. / Fornito con cavo e spina rimovibile.

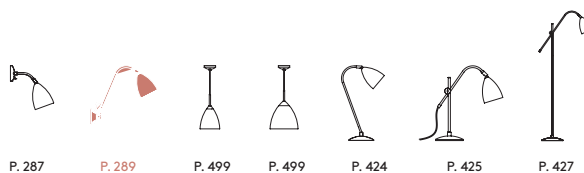

▼ Lamp excluded, see page 714 / La lampe exclu, voir page 714 / La lampadina esclusi a pagina 714 / Das Leuchtmittel ist ausgeschlossen, sie auf Seite 714.



READING

LISEUSES · LESELEUCHTEN · LUCI DI LETTURA



● SIDE BY SIDE
P. 293



● TELEGRAPH
READER
P. 295



● NAPOLI
READER
P. 297



● NAPOLI LED
P. 299



● RAVELLO LED
P. 301



● AZUMI READER
P. 303



● PARK LANE READER
P. 305



● **NEW**
FOLD WALL
P. 307



● ASCOLI SWING
P. 309



● ENNA WALL
P. 311



● ENNA SQUARE
P. 313



● ENNA SURFACE
P. 315



● ENNA RECESS
P. 317



● MICRO RECESS
P. 319



● **NEW**
FUSE/USB
P. 321



● DIGIT
P. 323



● TOSCA
P. 325



● LEO SWITCHED
P. 327



● FOSSO
P. 329



● LINDOS
P. 331



● EDGE READER MINI
P. 333



● EDGE READER
P. 335

LED





SIDE BY SIDE

| | | | LAMP | WATT | INPUT | K | CRI | CLASS | ⓘ |
|-------------------|-------------------|-------------------|--|------|------------|------|-----|-------|---|
| MB 1406002 | MN 1406003 | Br 1406004 | E27 LED [▼] + Integral LED (4.1W) 12W max | | Mains 230V | 2700 | 90 | ⊕ | ✓ |

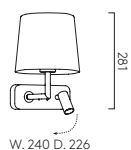

CONE 180

- WF** 5018035
- BF** 5018036
- OF** -
- PF** 5018037
- MF** 5018044

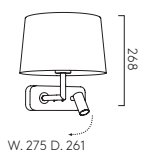

TAPERED ROUND 250

- WF** 5035003
- BF** 5035004
- OF** -
- PF** 5035005
- MF** 5035023

P. 716: Special Shade Colours
Couleurs spéciales / Sonderfarben / Colori speciali

CAN BE MOUNTED IN 3 ORIENTATIONS / Montage reversible (gauche/droite) / Kann beidseitig montiert werden / Può essere montato anche rivolto verso l'alto.

[▼] Lamp excluded, see page 714 / La lampe exclu, voir page 714 / La lampadina esclusi a pagina 714 / Das Leuchtmittel ist ausgeschlossen, sie auf Seite 714.

LED





TELEGRAPH READER (1404014 + 5035005)



TELEGRAPH READER (1404013 + 5035005)

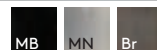

TELEGRAPH READER

SHADE EXCLUDED

| | LAMP | WATT | INPUT | K | CRI | CLASS | |
|---|--|---------|------------|------|-----|-------|--|
| MB 1404013 MN 1404014 Br 1404015 | E27 LED [▼] + Integral LED (2W) | 12W max | Mains 230V | 2700 | 90 | | |

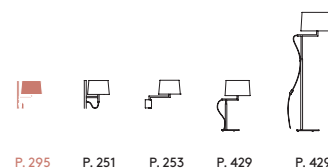
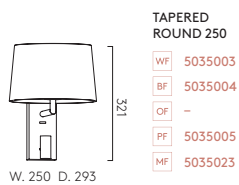

P. 716: Special Shade Colours
Couleurs spéciales / Sonderfarben /
Colori speciali

[▼] Lamp excluded, see page 714 / La lampe exclu, voir
page 714 / La lampadina esclusi a pagina 714 / Das
Leuchtmittel ist ausgeschlossen, sie auf Seite 714.

LED





NAPOLI READER (1185003 + 5014001)

MN

NAPOLI READER

SHADE EXCLUDED

| | LAMP | WATT | INPUT | K | CRI | CLASS | |
|------------|--|---------|------------|------|-----|-------|---|
| MN 1185003 | E27 LED [▼] + Integral LED (2W) | 12W max | Mains 230V | 2700 | 90 | | ✓ |

OVAL 285

W. 285 D. 160

- 5014001
- 5014002
- 5014003
- 5014004
- 5014016

P. 716: Special Shade Colours
Couleurs spéciales / Sonderfarben /
Colori speciali

[▼] Lamp excluded, see page 714 / La lampe exclu, voir
page 714 / La lampadina esclusi a pagina 714 / Das
Leuchtmittel ist ausgeschlossen, sie auf Seite 714.

LED





NAPOLI LED (1185002 + 5014002)



NAPOLI LED (1185002 + 5014003)

MN

NAPOLI LED

SHADE EXCLUDED

| | LAMP | WATT | INPUT | K | CRI | CLASS | |
|-------------------|--|---------|------------|------|-----|-------|--|
| MN 1185002 | E27 LED [▼] + Integral LED (1W) | 12W max | Mains 230V | 3000 | 90 | | |

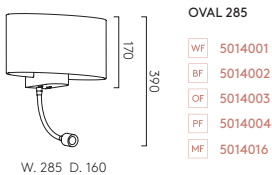

P. 716: Special Shade Colours
Couleurs spéciales / Sonderfarben /
Colori speciali

[▼] Lamp excluded, see page 714 / La lampe exclu, voir
page 714 / La lampadina esclusi a pagina 714 / Das
Leuchtmittel ist ausgeschlossen, sie auf Seite 714.

LED

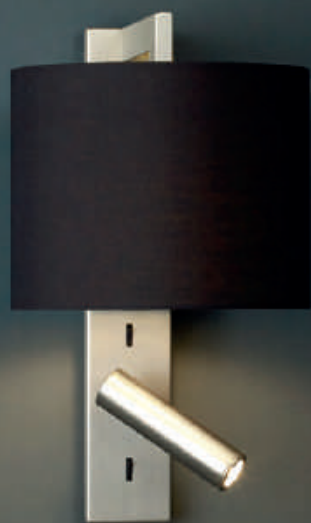



RAVELLO LED READER (1222018 + 5016020)



RAVELLO LED READER (1222020 + 5016021)



RAVELLO LED READER

SHADE EXCLUDED

| | LAMP | WATT | INPUT | K | CRI | Lm | CLASS |
|--------------------|-------------------|-------------------|------------------------------|---------|------------|------|--------|
| PCh 1222018 | MN 1222019 | Br 1222020 | E27 LED* + Integral LED (2W) | 12W max | Mains 230V | 2700 | 90 111 |

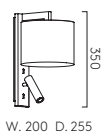

DRUM 200

- WF 5016020
- BF 5016021
- OF 5016022
- PF 5016029
- MF 5016076

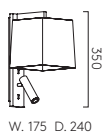

RAVELLO TAPERED SQUARE 175

- WF 5030004
- BF 5030003
- OF 5030005
- PF 5030006
- MF -

P. 716: Special Shade Colours
Couleurs spéciales / Sonderfarben / Colori speciali

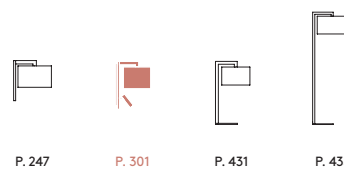

▼ Lamp excluded, see page 714 / La lampe exclu, voir page 714 / La lampadina esclusi a pagina 714 / Das Leuchtmittel ist ausgeschlossen, sie auf Seite 714.

LED





AZUMI READER (1142033 + 5006003)



AZUMI READER (1142034 + 5005003)



AZUMI READER

SHADE EXCLUDED

| | LAMP | WATT | INPUT | K | CRI | Lm | CLASS | |
|--|--|---------|------------|------|-----|----|-------|--|
| PCh 1142033 MN 1142034 Br 1142048 | E27 LED [▼] + Integral LED (2.2W) | 12W max | Mains 230V | 2700 | 90 | 76 | | |

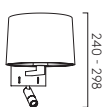

W. 215 D. 247

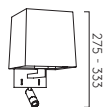

W. 215 D. 224

TAPERED ROUND 215

- WF 5006001
- BF 5006002
- OF 5006003
- PF 5006004
- MF 5035011

TAPERED SQUARE 175

- WF 5005001
- BF 5005002
- OF 5005003
- PF 5005004
- MF -

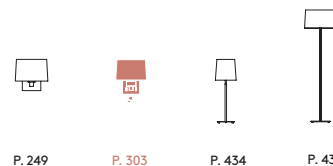

P. 716: Special Shade Colours
Couleurs spéciales / Sonderfarben / Colori speciali

[▼] Lamp excluded, see page 714 / La lampe exclu, voir page 714 / La lampadina esclusi a pagina 714 / Das Leuchtmittel ist ausgeschlossen, sie auf Seite 714.





PARK LANE READER (1080029 + 5001007)



PARK LANE READER (1080051 + 5001001)

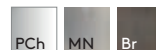

PARK LANE READER

SHADE EXCLUDED

| | LAMP | WATT | INPUT | K | CRI | Lm | CLASS |
|---|--|---------|------------|------|-----|----|-------|
| PCh 1080029 MN 1080030 Br 1080051 | E27 LED [▼] + Integral LED (2.2W) | 12W max | Mains 230V | 2700 | 90 | 76 | ✓ |

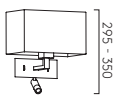

W. 285 D. 187

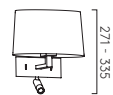

W. 300 D. 185

RECTANGLE 285

- WF 5001001
- BF 5001003
- OF 5001007
- PF 5001017
- MF 5011009

TAPERED OVAL*

- WF 5034001
- BF 5034002
- OF 5034003
- PF 5034004
- MF -

P. 716: Special Shade Colours / Couleurs spéciales / Sonderfarben / Colori speciali

* To be used with CFL/LED lamp only / Pour utilisation avec lampe CFL/LED seulement. / nur mit Kompaktleuchtstofflampe //LED verwenden / Solo per l'uso con lampade a CFL/LED.

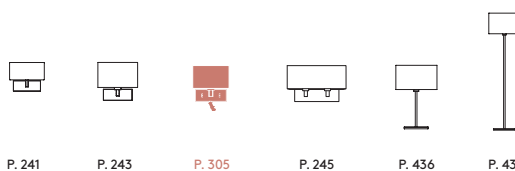

▼ Lamp excluded, see page 714 / La lampe exclu, voir page 714 / La lampadina esclusi a pagina 714 / Das Leuchtmittel ist ausgeschlossen, sie auf Seite 714.

LED





FOLD WALL (1408003)



FOLD WALL (1408001)



NEW FOLD WALL LED

| | LAMP | WATT | INPUT | K | CRI | Lm | CLASS | |
|------------|--------------|------|------------|------|-----|-----|-------|---|
| MW 1408001 | Integral LED | 5W | Mains 230V | 2700 | 90 | 151 | ⊕ | ✓ |
| MB 1408002 | | | | | | | | |
| MN 1408003 | | | | | | | | |

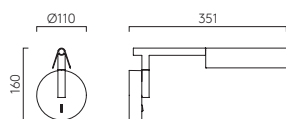

FOLD WALL

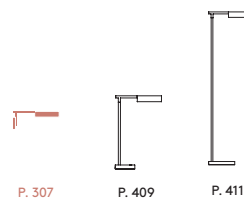

LED





ASCOLI SWING (1286065)



ASCOLI SWING (1286067)



ASCOLI SWING (1286088)



NEW

ASCOLI SWING

TW 1286065 MN 1286066 Br 1286067 MB 1286088

LAMP WATT CLASS

GU10 LED ▼ 6W max □ ✓



ASCOLI SWING

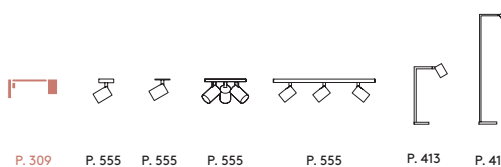

▼ Lamp excluded, see page 714 / La lampe exclu, voir page 714 / La lampadina esclusi a pagina 714 / Das Leuchtmittel ist ausgeschlossen, sie auf Seite 714.

LED





ENNA WALL (1058056)



ENNA WALL (1058033)



ENNA WALL (1058032)



ENNA WALL

| | LAMP | WATT | INPUT | K | CRI | Lm | CLASS |
|---|--------------|------|------------|------|-----|-----|-------|
| MW 1058032 MB 1058033 MN 1058056 MG 1058105 | Integral LED | 4.7W | Mains 230V | 2700 | 90 | 105 | |

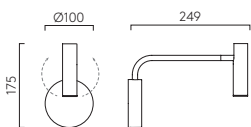

ENNA WALL

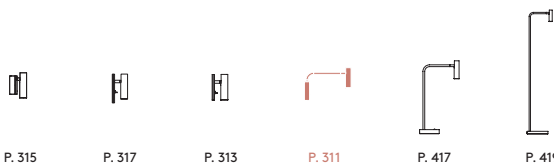

LED





ENNA SQUARE SWITCHED (1058018)



ENNA SQUARE SWITCHED (1058085)



ENNA SQUARE SWITCHED (1058016)



ENNA SQUARE SWITCHED

| | LAMP | WATT | INPUT | K | CRI | Lm | CLASS | | | | | | | |
|--|-------------------|-------------------|-------------------|--------------------|-------------------|-------------------|--------------|------|------------|------|----|-----|---|---|
| <table border="0"> <tr> <td>TW 1058016</td> <td>Br 1058085</td> <td>MN 1058018</td> </tr> <tr> <td>PCh 1058019</td> <td>MB 1058024</td> <td>MG 1058030</td> </tr> </table> | TW 1058016 | Br 1058085 | MN 1058018 | PCh 1058019 | MB 1058024 | MG 1058030 | Integral LED | 4.5W | Mains 230V | 2700 | 90 | 111 | ⊕ | ✓ |
| TW 1058016 | Br 1058085 | MN 1058018 | | | | | | | | | | | | |
| PCh 1058019 | MB 1058024 | MG 1058030 | | | | | | | | | | | | |

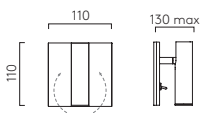

ENNA SQUARE SWITCHED

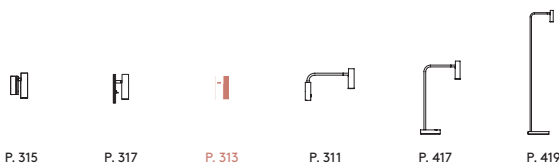

This product is available without a switch by special order with a minimum order quantity of 100 pcs / Cet article est disponible sans interrupteur dans le cadre d'une commande spéciale, pour une quantité minimum de 100 pièces. / Dieses Produkt ist ohne Schalter bei Bestellung einer Mindestbestellmenge von 100 Stück verfügbar. / Questo articolo è disponibile senza interruttore solo dietro ordine speciale con quantità minima di 100 pz.

LED





ENNA SURFACE (1058084)



ENNA SURFACE (1058027)



ENNA SURFACE

- Br 1058084
- MN 1058013
- PCh 1058014
- MW 1058015
- MB 1058027
- MG 1058108

| LAMP | WATT | INPUT | K | CRI | Lm | CLASS | |
|--------------|------|------------|------|-----|-----|-------|--|
| Integral LED | 4.5W | Mains 230V | 2700 | 90 | 111 | | |

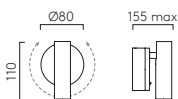

ENNA SURFACE

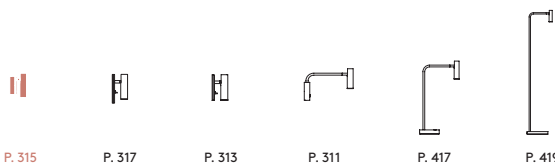

This product is available without a switch by special order with a minimum order quantity of 100 pcs / Cet article est disponible sans interrupteur dans le cadre d'une commande spéciale, pour une quantité minimum de 100 pièces. / Dieses Produkt ist ohne Schalter bei Bestellung einer Mindestbestellmenge von 100 Stück verfügbar. / Questo articolo è disponibile senza interruttore solo dietro ordine speciale con quantità minima di 100 pz.

LED





ENNA RECESS SWITCHED (1058064)



ENNA RECESS SWITCHED (1058062)



ENNA RECESS SWITCHED

| | LAMP | WATT | INPUT | K | CRI | Lm | CLASS | |
|-------------|--------------|------|------------|------|-----|-----|-------|---|
| MW 1058062 | Integral LED | 3.9W | Mains 230V | 2700 | 90 | 151 | ⊕ | ✓ |
| PCh 1058064 | | | | | | | | |
| MN 1058065 | | | | | | | | |
| Br 1058088 | | | | | | | | |
| MB 1058067 | | | | | | | | |

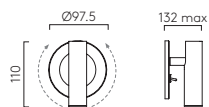

ENNA RECESS SWITCHED

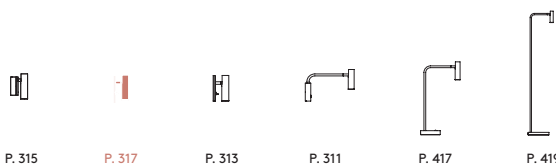

This product is available without a switch by special order with a minimum order quantity of 100 pcs / Cet article est disponible sans interrupteur dans le cadre d'une commande spéciale, pour une quantité minimum de 100 pièces. / Dieses Produkt ist ohne Schalter bei Bestellung einer Mindestbestellmenge von 100 Stück verfügbar. / Questo articolo è disponibile senza interruttore solo dietro ordine speciale con quantità minima di 100 pz.

LED





MICRO RECESS SWITCHED (1407010)



MICRO RECESS UNSWITCHED (1407003)

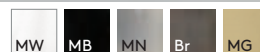

MICRO RECESS

| | | | | | | LAMP | WATT | INPUT | K | CRI | Lm | CLASS | |
|-------------------|------------|------------|------------|------------|------------|--------------|------|------------|------|-----|-----|-------|---|
| SWITCHED | MW 1407006 | MB 1407007 | MN 1407008 | Br 1407009 | MG 1407010 | Integral LED | 3.4W | Mains 230V | 2700 | 90 | 166 | ⊕ | ✓ |
| UNSWITCHED | MW 1407001 | MB 1407002 | MN 1407003 | Br 1407004 | MG 1407005 | Integral LED | 2W | 700mA▼ | 2700 | 90 | 164 | ⊕ | - |

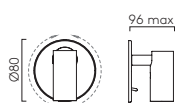

MICRO RECESS SWITCHED

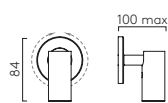

MICRO RECESS UNSWITCHED

▼ Driver excluded, see page 713 / Driver d'entrée exclu, voir page 713 / Driver esclusi a pagina 713 / Das treiber ist ausgeschlossen, sie auf Seite 713

LED





FUSE SWITCHED (1215038)



FUSE USB SWITCHED (1215084)



FUSE

SWITCHED

| | LAMP | WATT | INPUT | K | CRI | Lm | CLASS | | |
|--|--------------|------|------------|------|-----|-----|-------|---|---|
| PCh 1215035 Br 1215038 MW 1215036 | Integral LED | 4.2W | Mains 230V | 2700 | 90 | 171 | ⊕ | ✓ | ✓ |
| MB 1215037 MN 1215039 | | | | | | | | | |

NEW

USB SWITCHED

| | | | | | | | | | |
|--|--------------|------|------------|------|----|-----|---|---|---|
| PCh 1215083 Br 1215085 MW 1215081 | Integral LED | 3.5W | Mains 230V | 2700 | 90 | 185 | ⊕ | ✓ | ✓ |
| MB 1215082 MN 1215084 MG 1215103 | | | | | | | | | |

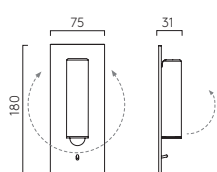

FUSE SWITCHED LED

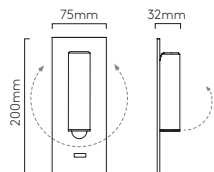

FUSE USB SWITCHED LED

This product is available without a switch by special order with a minimum order quantity of 100 pcs / Cet article est disponible sans interrupteur dans le cadre d'une commande spéciale, pour une quantité minimum de 100 pièces. / Dieses Produkt ist ohne Schalter bei Bestellung einer Mindestbestellmenge von 100 Stück verfügbar. / Questo articolo è disponibile senza interruttore solo dietro ordine speciale con quantità minima di 100 pz.

LED





DIGIT (1323007)



DIGIT II (1323010)



DIGIT

| | LAMP | WATT | INPUT | K | CRI | Lm | CLASS | □ | ⊕ |
|---------------|--------------|------|------------|------|-----|-----|-------|---|---|
| LED | Integral LED | 3.9W | Mains 230V | 2700 | 80 | 114 | □ | ✓ | ✓ |
| LED II | Integral LED | 4.4W | Mains 230V | 2700 | 90 | 175 | ⊕ | ✓ | ✓ |

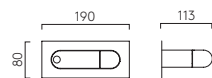

DIGIT LED / LED II

CAN BE MOUNTED EITHER WAY ROUND / Montage reversible (gauche / droite) / Kann beidseitig montiert werden / Può essere montato anche rivolto verso l'alto.

LED





TOSCA (1157012)



TOSCA (1157003)

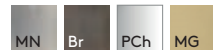

TOSCA

| | LAMP | WATT | INPUT | K | CRI | Lm | CLASS | | |
|-------------|--------------|------|------------|------|-----|----|-------|---|-----|
| MN 1157001 | Integral LED | 2.2W | Mains 230V | 2700 | 90 | 61 | | ⏚ | ✓ ✓ |
| Br 1157012 | | | | | | | | | |
| PCh 1157003 | | | | | | | | | |
| MG 1157007 | | | | | | | | | |

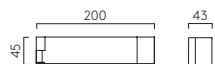

TOSCA

CAN BE MOUNTED EITHER WAY ROUND / Montage reversible (gauche/droite) / Kann beidseitig montiert werden / Può essere montato anche rivolto verso l'alto.

LED





LEO SWITCHED (1295002)



LEO SWITCHED

| | LAMP | WATT | INPUT | K | CRI | Lm | CLASS | ⏏ | ⚡ |
|-------------|--------------|------|------------|------|-----|-----|-------|---|---|
| PCh 1295001 | Integral LED | 4W | Mains 230V | 3000 | 90 | 193 | ⏏ | ✓ | ✓ |
| MN 1295002 | | | | | | | | | |
| Br 1295003 | | | | | | | | | |

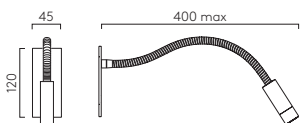

LEO SWITCHED

This product is available without a switch by special order with a minimum order quantity of 100 pcs / Cet article est disponible sans interrupteur dans le cadre d'une commande spéciale, pour une quantité minimum de 100 pièces. / Dieses Produkt ist ohne Schalter bei Bestellung einer Mindestbestellmenge von 100 Stück verfügbar. / Questo articolo è disponibile senza interruttore solo dietro ordine speciale con quantità minima di 100 pz.

LED





FOSSO SWITCHED (1138011)



FOSSO SWITCHED (1138005)

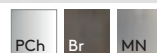

FOSSO

| | LAMP | WATT | INPUT | K | CRI | Lm | CLASS | |
|--------------------|--------------|------|------------|------|-----|----|-------|---|
| SWITCHED* | | | | | | | | |
| PCh 1138005 | Integral LED | 2.5W | Mains 230V | 3000 | 90 | 90 | ⊕ | ✓ |
| Br 1138011 | | | | | | | | |
| MN 1138008 | | | | | | | | |

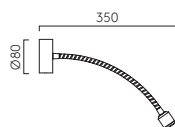

FOSSO

* This product is available without a switch by special order with a minimum order quantity of 100 pcs / Cet article est disponible sans interrupteur dans le cadre d'une commande spéciale, pour une quantité minimum de 100 pièces. / Dieses Produkt ist ohne Schalter bei Bestellung einer Mindestbestellmenge von 100 Stück verfügbar. / Questo articolo è disponibile senza interruttore solo dietro ordine speciale con quantità minima di 100 pz.

LED





LINDOS SWITCHED (1316007)



LINDOS SWITCHED (1316010)



LINDOS SWITCHED

| | LAMP | WATT | INPUT | K | CRI | Lm | CLASS | |
|-------------|------------|------------|--------------|------|------------|-------------|-------|---|
| PCh 1316007 | MN 1316008 | Br 1316010 | Integral LED | 2.3W | Mains 230V | 3000 90 102 | □ | ✓ |

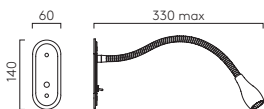

LINDOS SWITCHED

This product is available without a switch by special order with a minimum order quantity of 100 pcs / Cet article est disponible sans interrupteur dans le cadre d'une commande spéciale, pour une quantité minimum de 100 pièces. / Dieses Produkt ist ohne Schalter bei Bestellung einer Mindestbestellmenge von 100 Stück verfügbar. / Questo articolo è disponibile senza interruttore solo dietro ordine speciale con quantità minima di 100 pz.

LED





EDGE READER MINI (1352018)

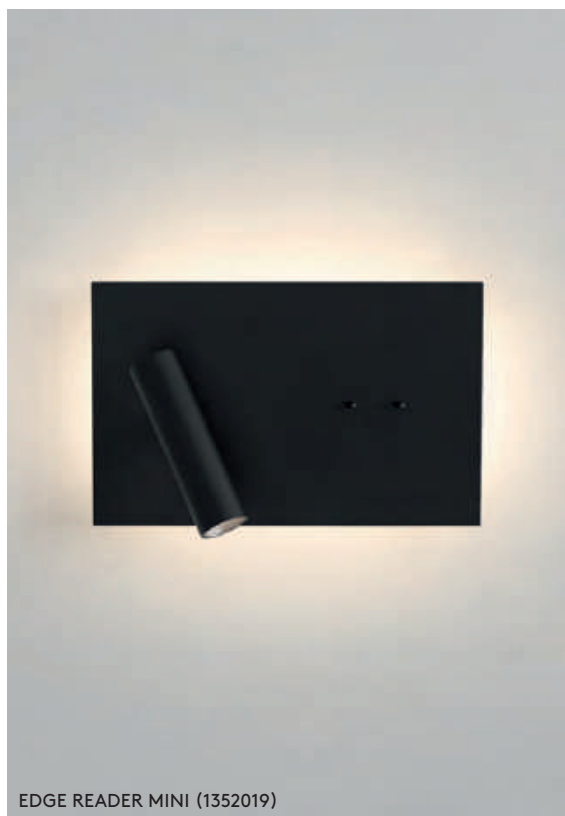

EDGE READER MINI (1352019)



EDGE READER MINI

| | LAMP | WATT | INPUT | K | CRI | Lm | CLASS | | |
|-------------------------------------|-------------------------|------|------------|------|-----|-----|-------|---|---|
| MW 1352018 MB 1352019 | Reader: Integral LED | 9.7W | Mains 230V | 2700 | 80 | 112 | | ✓ | ✓ |
| | Backlight: Integral LED | 4.1W | Mains 230V | 2700 | 90 | 149 | - | ✓ | ✓ |

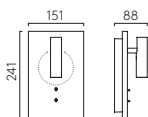

EDGE READER MINI

LED





EDGE READER (1352007)



EDGE READER

| | | LAMP | WATT | INPUT | K | CRI | Lm | CLASS | | |
|----------------------|------------|------------|--------------|-------|------------|------|----|-------|---|---|
| EDGE READER | MW 1352007 | Reader: | Integral LED | 14.8W | Mains 230V | 2700 | 80 | 427 | ⊕ | ✓ |
| | | Backlight: | Integral LED | 4.1W | Mains 230V | 2700 | 90 | 123 | - | ✓ |
| SINGLE SWITCH | MW 1352008 | Reader: | Integral LED | 15.7W | Mains 230V | 2700 | 80 | 548 | ⊕ | ✓ |
| | | Backlight: | Integral LED | 4.1W | Mains 230V | 2700 | 90 | 120 | - | ✓ |

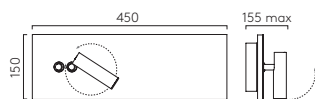

EDGE READER

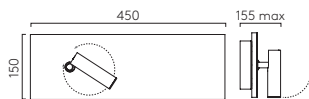

EDGE READER SINGLE SWITCH





PLASTER & CERAMIC

APPLIQUES EN PLÂTRE ET CÉRAMIQUE · GIPS - UND KERAMIKLEUCHTEN · LAMPADRE IN GESSO E CERAMICA



NEW
VELO
P. 341



NEW
SHADOW
P. 343



●
PARMA 100/110
P. 345



●
PARMA 160/210
P. 347



●
PARMA 250/625
P. 349



●
RIO
P. 351



PELLA
P. 353



●
PIENZA
P. 355



KOZA
P. 357



KYMI
P. 359



PERO
P. 361



MOSTO
P. 361



BRENTA
P. 363



S-LIGHT
P. 364



BOLOGNA 240
P. 365



●
SERIFOS
P. 367



●
ECLIPSE ROUND
P. 369



●
ECLIPSE SQUARE
P. 369



ARIA
P. 371



KYO
P. 373



GOSFORD
P. 375



MILO
P. 377



AMALFI
P. 379

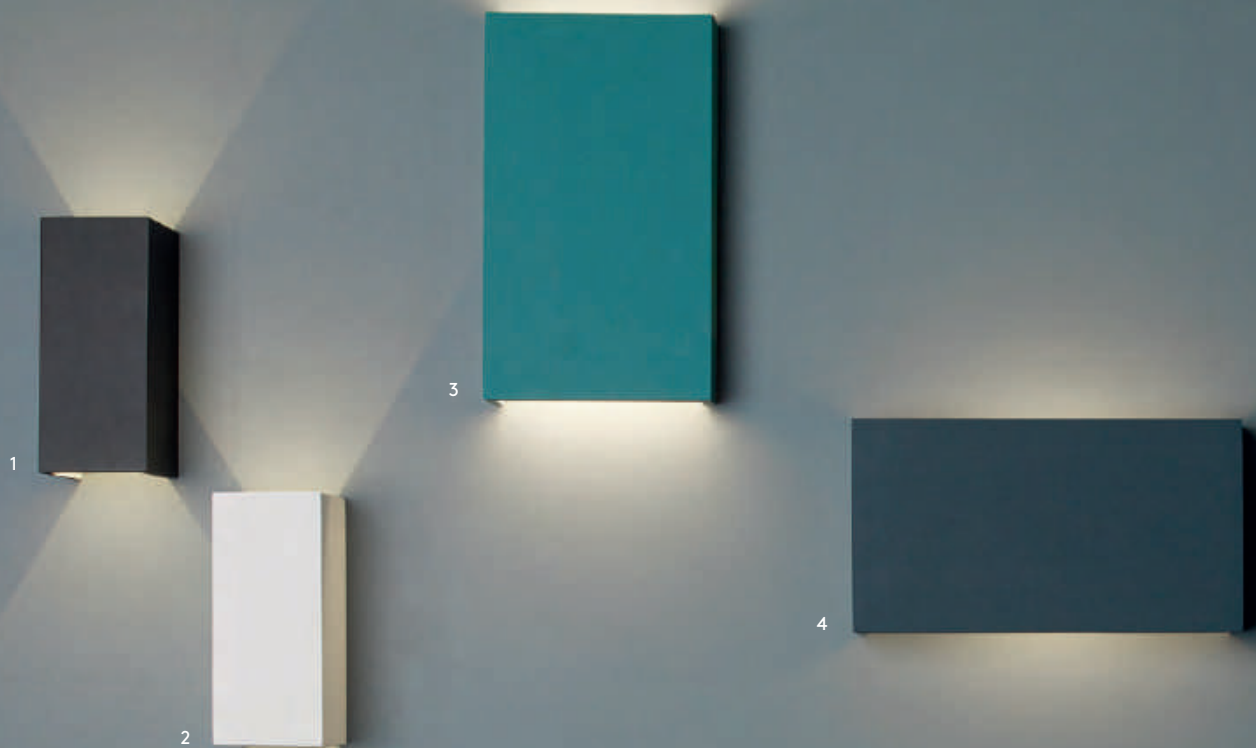

1. PARMA 210 P. 341
2. PARMA 210 P. 341
3. RIO 190 P. 345

4. PELLA 325 P. 347
5. SERIFOS 170 P. 361
6. PELLA 325 P. 347

7. BOLOGNA 160 P. 359
8. BOLOGNA 160 P. 359



5

7

8

6

PRODUCTS HAVE BEEN PAINTED
Le produit a été peint
Das Produkt wurde lackiert
Il prodotto e' stato verniciato





VELO 280 (1417001)



VELO 390 (1417002)



NEW VELO

| | | LAMP | WATT | CLASS | |
|-----|---------|----------|-------------|-------|---|
| 280 | 1417001 | E27 LED▼ | 12W max | | ✓ |
| 390 | 1417002 | E27 LED▼ | 2 x 12W max | | ✓ |

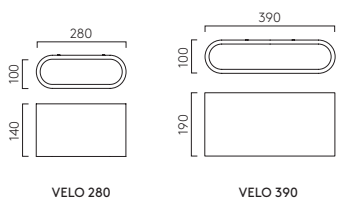

Can be painted / Peut être peint / kann lackiert werden / Può essere verniciato

▼ Lamp excluded, see page 714 / La lampe exclu, voir page 714 / La lampadina esclusi a pagina 714 / Das Leuchtmittel ist ausgeschlossen, sie auf Seite 714.





SHADOW 150 (1414001)



SHADOW 300 (1414002)

P

NEW SHADOW

| | | LAMP | WATT | CLASS | |
|-----|---------|-----------|------------|-------|---|
| 150 | 1414001 | GU10 LED▼ | 1 x 6W max | | ✓ |
| 300 | 1414002 | GU10 LED▼ | 2 x 6W max | | ✓ |

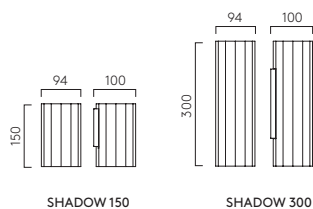

Can be painted / Peut être peint / kann lackiert werden / Può essere verniciato

▼ Lamp excluded, see page 714 / La lampe exclu, voir page 714 / La lampadina esclusi a pagina 714 / Das Leuchtmittel ist ausgeschlossen, sie auf Seite 714.

LED





PARMA 110 (1187009)



PARMA 100 LED (1187004)

P

PARMA

| | LAMP | WATT | INPUT | K | CRI | Lm | CLASS | | |
|---|--------------|--------|------------|------|-----|-----|-------|---|---|
| 100 LED P 1187004 | Integral LED | 4W | Mains 230V | 3000 | 80 | 104 | | - | ✓ |
| 100 LED P 1187016 | Integral LED | 3.9W | Mains 230V | 2700 | 80 | 76 | | - | ✓ |
| 110 P 1187009 | GU10 LED▼ | 6W max | - | - | - | - | | ✓ | - |

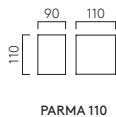
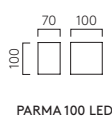

Can be painted / Peut être peint / kann lackiert werden / Può essere verniciato

▼ Lamp excluded, see page 714 / La lampe exclu, voir page 714 / La lampadina esclusi a pagina 714 / Das Leuchtmittel ist ausgeschlossen, sie auf Seite 714.

LED





PARMA 160 LED (1187001)



PARMA 210 LED (1187019)



PARMA

| | | LAMP | WATT | INPUT | K | CRI | Lm | CLASS | | |
|---------|---------|--------------|------------|------------|------|-----|-----|-------|---------------|---|
| 160 LED | 1187001 | Integral LED | 6.4W | Mains 230V | 3000 | 80 | 134 | | - | ✓ |
| 160 LED | 1187014 | Integral LED | 6.4W | Mains 230V | 2700 | 80 | 155 | | - | ✓ |
| 210 | 1187003 | GU10 LED▼ | 2 x 6W max | - | - | - | - | | ✓ | - |
| 210 LED | 1187019 | Integral LED | 8W | Mains 230V | 2700 | 80 | 550 | | Phase + 1-10V | ✓ |
| 210 LED | 1187021 | Integral LED | 7.7W | Mains 230V | 3000 | 80 | 504 | | Phase + 1-10V | ✓ |

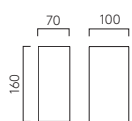

PARMA 160 LED

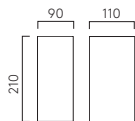

PARMA 210 / 210 LED



Can be painted / Peut être peint / kann lackiert werden / Può essere verniciato

▼ Lamp excluded, see page 714 / La lampe exclu, voir page 714 / La lampadina esclusi a pagina 714 / Das Leuchtmittel ist ausgeschlossen, sie auf Seite 714.

LED



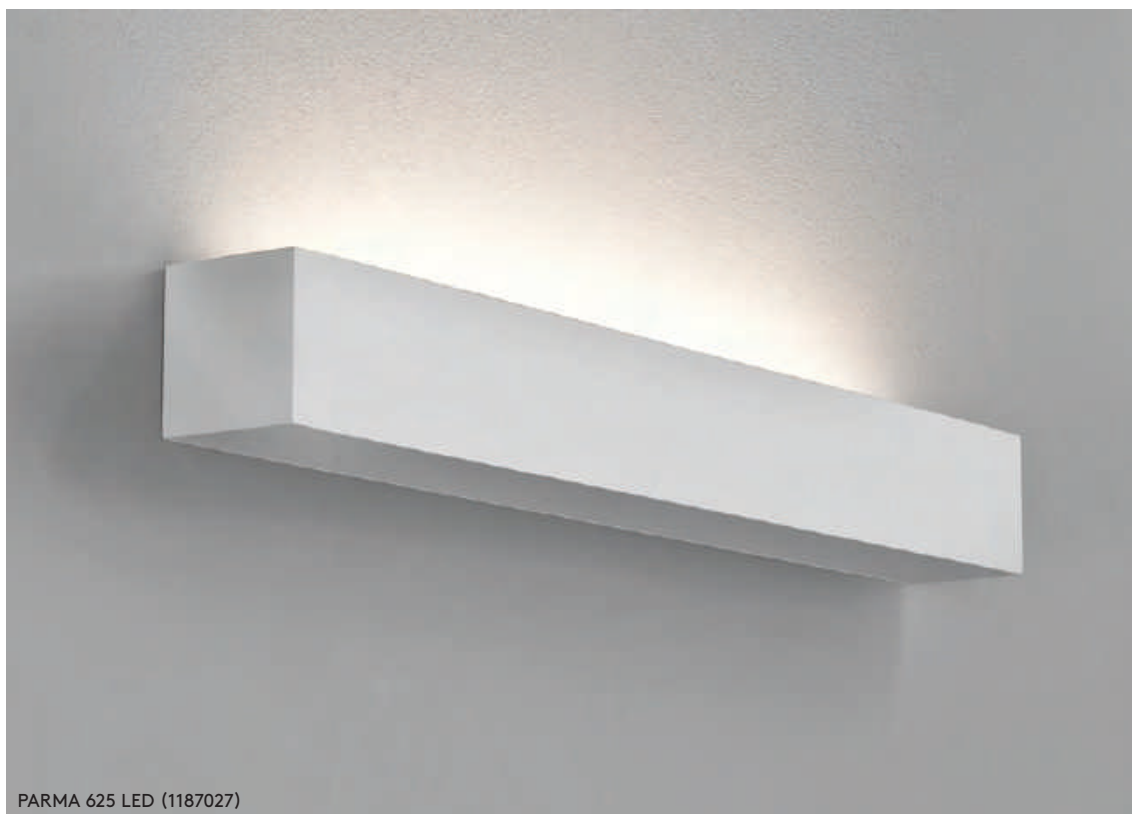

PARMA 625 LED (1187027)



PARMA

| | | LAMP | WATT | INPUT | K | CRI | Lm | CLASS | | |
|---------|---------|--------------|-----------|------------|------|-----|------|-------|---|---|
| 200 | 1187005 | E14 LED▼ | 7W max | - | - | - | - | | ✓ | - |
| 250 LED | 1187002 | Integral LED | 9W | Mains 230V | 3000 | 80 | 301 | | - | ✓ |
| 250 LED | 1187015 | Integral LED | 8.7W | Mains 230V | 2700 | 80 | 319 | | - | ✓ |
| 625 LED | 1187027 | Integral LED | 29.5W max | Mains 230V | 2700 | 80 | 1497 | | ✓ | ✓ |

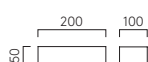

PARMA 200

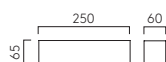

PARMA 250 LED

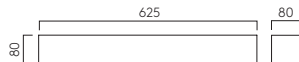

PARMA 625 LED

Can be painted / Peut être peint / kann lackiert werden / Può essere verniciato

▼ Lamp excluded, see page 714 / La lampe exclu, voir page 714 / La lampadina esclusi a pagina 714 / Das Leuchtmittel ist ausgeschlossen, sie auf Seite 714.

LED





RIO 325 (1325009)



RIO 190 (1325002)



RIO

| | | LAMP | WATT | INPUT | K | CRI | Lm | CLASS | | |
|-----|---------|--------------|-------|------------|------|-----|------|-------|-------|---|
| 125 | 1325007 | Integral LED | 5.7W | Mains 230V | 2700 | 90 | 197 | | - | ✓ |
| 190 | 1325002 | Integral LED | 14.6W | Mains 230V | 3000 | 80 | 1228 | | 1-10V | ✓ |
| 190 | 1325006 | Integral LED | 15.1W | Mains 230V | 2700 | 80 | 1366 | | 1-10V | ✓ |
| 190 | 1325010 | Integral LED | 16.6W | Mains 230V | 2700 | 80 | 1637 | | Phase | ✓ |
| 210 | 1325008 | Integral LED | 5.9W | Mains 230V | 2700 | 90 | 195 | | - | ✓ |
| 325 | 1325001 | Integral LED | 14.7W | Mains 230V | 3000 | 80 | 1198 | | 1-10V | ✓ |
| 325 | 1325005 | Integral LED | 15.1W | Mains 230V | 2700 | 80 | 1134 | | 1-10V | ✓ |
| 325 | 1325009 | Integral LED | 16.4W | Mains 230V | 2700 | 80 | 1551 | | Phase | ✓ |

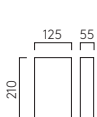

RIO 125

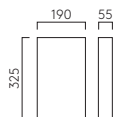

RIO 190

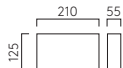

RIO 210

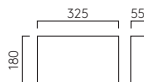

RIO 325



Can be painted / Peut être peint / kann lackiert werden / Può essere verniciato





PELLA 190 (1315002)



PELLA

| | LAMP | WATT | CLASS | |
|--------------------|------------|------------|-------|---|
| 190 1315002 | GU10 LED ▼ | 2 x 6W max | | ✓ |
| 325 1315001 | E27 LED ▼ | 12W max | | ✓ |

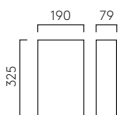

PELLA 190

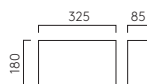

PELLA 325



Can be painted / Peut être peint / kann lackiert werden / Può essere verniciato

▼ Lamp excluded, see page 714 / La lampe exclu, voir page 714 / La lampadina esclusi a pagina 714 / Das Leuchtmittel ist ausgeschlossen, sie auf Seite 714.

LED





PIENZA 165 (1196003)



PIENZA 140 SWITCHED (1196004)



PIENZA

| | | LAMP | WATT | INPUT | K | CRI | Lm | CLASS | | | |
|---------------------|---------|--------------|---------|------------|------|-----|-----|-------|---|---|---|
| 140 | 1196001 | E14 LED ▼ | 7W max | - | - | - | - | | ✓ | - | - |
| 140 SWITCHED | 1196004 | E14 LED ▼ | 7W max | - | - | - | - | | ✓ | ✓ | - |
| 140 LED | 1196002 | Integral LED | 6.2W | Mains 230V | 3000 | 90 | 199 | | - | - | ✓ |
| 140 LED | 1196006 | Integral LED | 5.7W | Mains 230V | 2700 | 90 | 357 | | - | - | ✓ |
| 165 | 1196003 | E27 LED ▼ | 12W max | - | - | - | - | | ✓ | - | - |

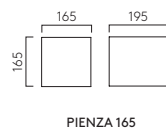
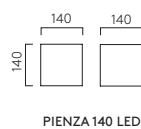
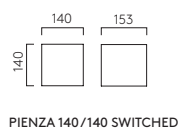

Can be painted / Peut être peint / kann lackiert werden / Può essere verniciato

▼ Lamp excluded, see page 714 / La lampe exclu, voir page 714 / La lampadina esclusi a pagina 714 / Das Leuchtmittel ist ausgeschlossen, sie auf Seite 714.





KOZA (1155001)



KOZA (1155001)



KOZA

P 1155001

| LAMP | WATT | CLASS | | | |
|----------|--------|-------|---|---|---|
| E14 LED▼ | 7W max | | ✓ | ✓ | ✓ |

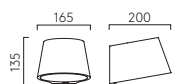

KOZA



Can be painted / Peut être peint / kann lackiert werden / Può essere verniciato

▼ Lamp excluded, see page 714 / La lampe exclu, voir page 714 / La lampadina esclusi a pagina 714 / Das Leuchtmittel ist ausgeschlossen, sie auf Seite 714.

PRODUCT HAS BEEN PAINTED
Le produit a été peint
Das Produkt wurde lackiert
Il prodotto è stato verniciato





KYMI 220 (1335001)



KYMI

| | | LAMP | WATT | CLASS | |
|-----|---------|-----------|------------|-------|---|
| 220 | 1335001 | GU10 LED▼ | 2 x 6W max | | ✓ |
| 300 | 1335003 | GU10 LED▼ | 2 x 6W max | | ✓ |

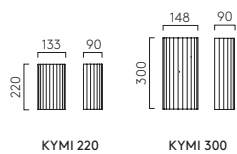

Can be painted / Peut être peint / kann lackiert werden / Può essere verniciato

▼ Lamp excluded, see page 714 / La lampe exclu, voir page 714 / La lampadina esclusi a pagina 714 / Das Leuchtmittel ist ausgeschlossen, sie auf Seite 714.





PERO (1172001)



MOSTO (1173001)



PERO

| | LAMP | WATT | CLASS | |
|---------|---------|--------|-------|---|
| 1172001 | G9 LED▼ | 3W max | | ✓ |

MOSTO

| | LAMP | WATT | CLASS | |
|---------|---------|--------|-------|---|
| 1173001 | G9 LED▼ | 3W max | | ✓ |

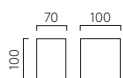

PERO

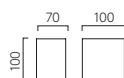

MOSTO



Can be painted / Peut être peint / kann lackiert werden / Può essere verniciato

▼ Lamp excluded, see page 714 / La lampe exclu, voir page 714 / La lampadina esclusi a pagina 714 / Das Leuchtmittel ist ausgeschlossen, sie auf Seite 714.





BRENTA 130 (1195001)



BRENTA 175 (1195003)



BRENTA

| | LAMP | WATT | CLASS | | |
|--------------|----------|---------|-------|---|---|
| 130 1195001 | E14 LED▼ | 7W max | | ✓ | ✓ |
| 175 1195003 | E27 LED▼ | 12W max | | ✓ | - |

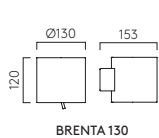

BRENTA 130

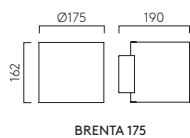

BRENTA 175



Can be painted / Peut être peint / kann lackiert werden / Può essere verniciato

▼ Lamp excluded, see page 714 / La lampe exclu, voir page 714 / La lampadina esclusi a pagina 714 / Das Leuchtmittel ist ausgeschlossen, sie auf Seite 714.



S-LIGHT (1213001)

P

S-LIGHT

P 1213001

LAMP WATT CLASS 

E14 LED ▼ 7W max  

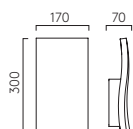

S-LIGHT



Can be painted / Peut être peint / kann lackiert werden / Può essere verniciato

▼ Lamp excluded, see page 714 / La lampe exclu, voir page 714 / La lampadina esclusi a pagina 714 / Das Leuchtmittel ist ausgeschlossen, sie auf Seite 714.



BOLOGNA 240 (1287002)



BOLOGNA 240

P 1287002

| LAMP | WATT | CLASS | |
|-----------|------------|-------|---|
| GU10 LED▼ | 2 x 6W max | | ✓ |



BOLOGNA 240



Can be painted / Peut être peint / kann lackiert werden / Può essere verniciato

▼ Lamp excluded, see page 714 / La lampe exclu, voir page 714 / La lampadina esclusi a pagina 714 / Das Leuchtmittel ist ausgeschlossen, sie auf Seite 714.

LED





SERIFOS 170 LED (1350001)



SERIFOS

| | LAMP | WATT | INPUT | K | CRI | Lm | CLASS | | | |
|----------------|---------|--------------|------------|------------|------|----|-------|--|---|---|
| 170 | 1350002 | Integral LED | 6W | Mains 230V | 2700 | 90 | 220 | | - | |
| 170 LED | 1350001 | Integral LED | 6.3W | Mains 230V | 3000 | 90 | 287 | | - | |
| 220 | 1350003 | GU10 LED | 2 x 6W max | - | - | - | | | - | - |

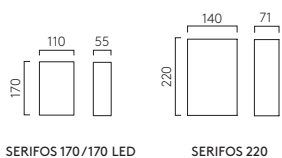

SERIFOS 170/170 LED

SERIFOS 220



Can be painted / Peut être peint / kann lackiert werden / Può essere verniciato

▼ Lamp excluded, see page 714 / La lampe exclu, voir page 714 / La lampadina esclusi a pagina 714 / Das Leuchtmittel ist ausgeschlossen, sie auf Seite 714.

LED



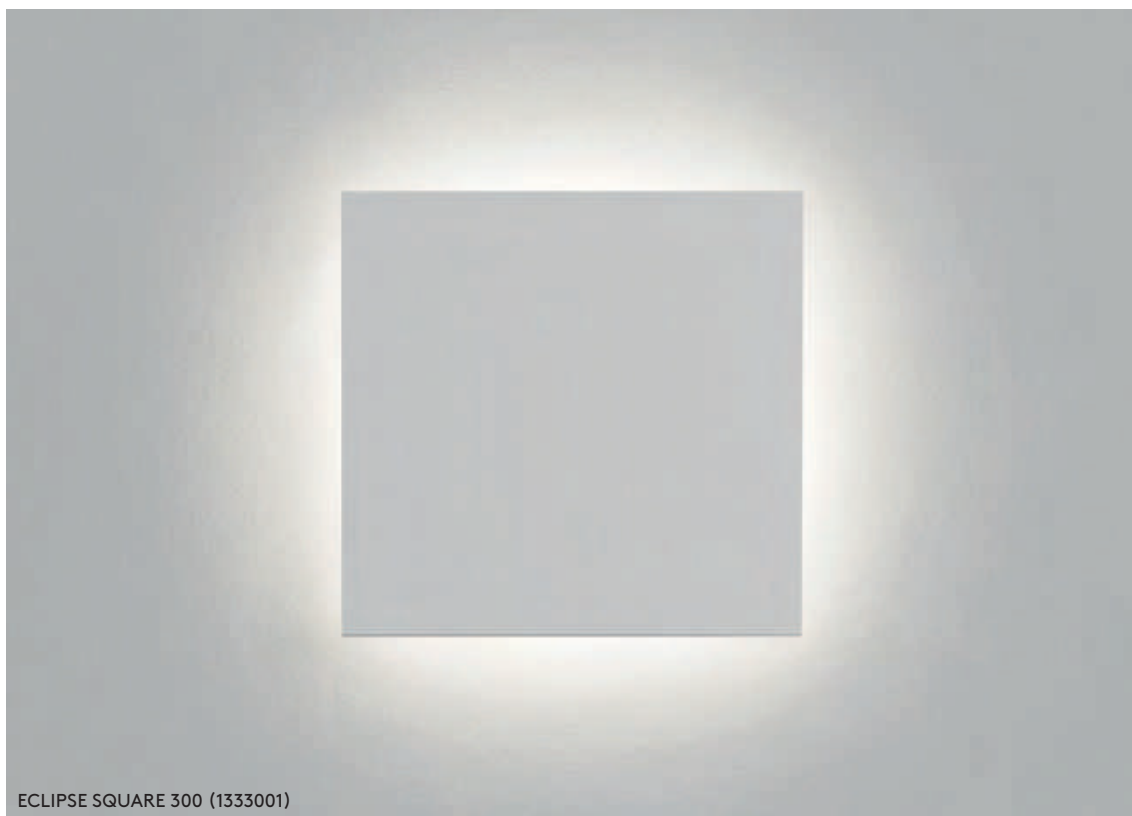

ECLIPSE SQUARE 300 (1333001)



ECLIPSE

| | | LAMP | WATT | INPUT | K | CRI | Lm | CLASS | |
|-------------------|---------|--------------|-------|------------|------|-----|-----|-------|---|
| ROUND 250 | 1333002 | Integral LED | 10.4W | Mains 230V | 3000 | 60 | 452 | | ✓ |
| ROUND 250 | 1333005 | Integral LED | 8.1W | Mains 230V | 2700 | 60 | 357 | | ✓ |
| ROUND 350 | 1333003 | Integral LED | 12.3W | Mains 230V | 3000 | 60 | 432 | | ✓ |
| ROUND 350 | 1333006 | Integral LED | 12.3W | Mains 230V | 2700 | 60 | 463 | | ✓ |
| SQUARE 300 | 1333001 | Integral LED | 15.1W | Mains 230V | 3000 | 60 | 716 | | ✓ |
| SQUARE 300 | 1333004 | Integral LED | 12.2W | Mains 230V | 2700 | 60 | 576 | | ✓ |

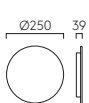

ROUND 250

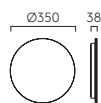

ROUND 350

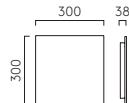

SQUARE 300



Can be painted / Peut être peint / kann lackiert werden / Può essere verniciato





ARIA 300 (1300001)



ARIA

| | | LAMP | WATT | CLASS | |
|-----|---------|----------|---------|-------|---|
| 300 | 1300001 | E27 LED▼ | 12W max | | ✓ |
| 370 | 1300002 | E27 LED▼ | 12W max | | ✓ |

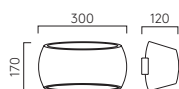

ARIA 300

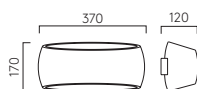

ARIA 370



Can be painted / Peut être peint / kann lackiert werden / Può essere verniciato

▼ Lamp excluded, see page 714 / La lampe exclu, voir page 714 / La lampadina esclusi a pagina 714 / Das Leuchtmittel ist ausgeschlossen, sie auf Seite 714.





KYO (1301001)



KYO

| | LAMP | WATT | CLASS | |
|------------------|-----------|---------|-------|---|
| C 1301001 | E27 LED ▼ | 12W max | | ✓ |

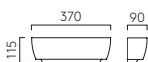

KYO



Can be painted / Peut être peint / kann lackiert werden / Può essere verniciato

▼ Lamp excluded, see page 714 / La lampe exclu, voir page 714 / La lampadina esclusi a pagina 714 / Das Leuchtmittel ist ausgeschlossen, sie auf Seite 714.





GOSFORD 340 (1383001)



GOSFORD

| | | LAMP | WATT | CLASS | |
|-----|---------|-----------|---------|-------|---|
| 340 | 1383001 | E27 LED ▼ | 12W max | | ✓ |
| 460 | 1383002 | E27 LED ▼ | 12W max | | ✓ |

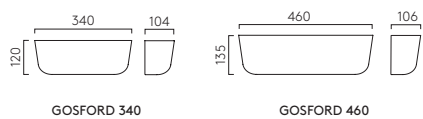

CAN BE PAINTED
 Peut être peint / kann lackiert
 werden / Può essere verniciato

▼ Lamp excluded, see page 714 / La lampe exclu, voir page 714 / La lampadina esclusi a pagina 714 / Das Leuchtmittel ist ausgeschlossen, sie auf Seite 714.





MILO 400 (1299002)



MILO

| | | LAMP | WATT | CLASS | |
|-----|---------|----------|---------|-------|---|
| 300 | 1299001 | E27 LED▼ | 12W max | | ✓ |
| 400 | 1299002 | E27 LED▼ | 12W max | | ✓ |

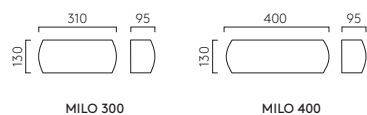

Can be painted / Peut être peint / kann lackiert werden / Può essere verniciato

▼ Lamp excluded, see page 714 / La lampe exclu, voir page 714 / La lampadina esclusi a pagina 714 / Das Leuchtmittel ist ausgeschlossen, sie auf Seite 714.





AMALFI 315 (1079001)



AMALFI

| | | LAMP | WATT | CLASS | 🔌 |
|-----|---|----------|---------|---|---|
| 315 |  1079001 | E27 LED▼ | 12W max |  | ✓ |
| 380 |  1079004 | E27 LED▼ | 12W max |  | ✓ |

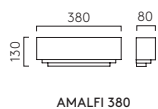
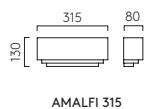

Can be painted / Peut être peint / kann lackiert werden / Può essere verniciato

▼ Lamp excluded, see page 714 / La lampe exclu, voir page 714 / La lampadina esclusi a pagina 714 / Das Leuchtmittel ist ausgeschlossen, sie auf Seite 714.

LED





EDGE 560D (1352006)

MW

EDGE

| | | LAMP | WATT | INPUT | K | CRI | Lm | CLASS | | |
|-------------|---------|--------------|-------|------------|------|-----|-----|-------|---|---|
| 560 | 1352001 | Integral LED | 15.5W | 700mA CC▼ | 3000 | 80 | 479 | | ✓ | ✓ |
| 560 | 1352004 | Integral LED | 14.7W | 700mA CC▼ | 2700 | 80 | 426 | | ✓ | ✓ |
| 560D | 1352006 | Integral LED | 14.7W | Mains 230V | 2700 | 80 | 426 | | - | ✓ |

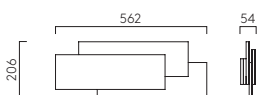

EDGE 560/560D

▼ The Edge 560 should be ordered with one of the following drivers:
 Le "Edge 560" devrait être commandé avec l'un des drivers suivants
 / Die Leuchte Edge 560 muss zusammen mit einem der folgenden
 Betriebsgeräte bestellt werden / Il Edge 560 deve essere ordinato
 con uno dei seguenti driver: 6008016, 6008020

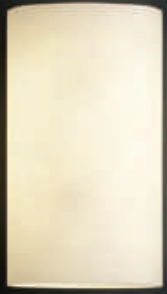

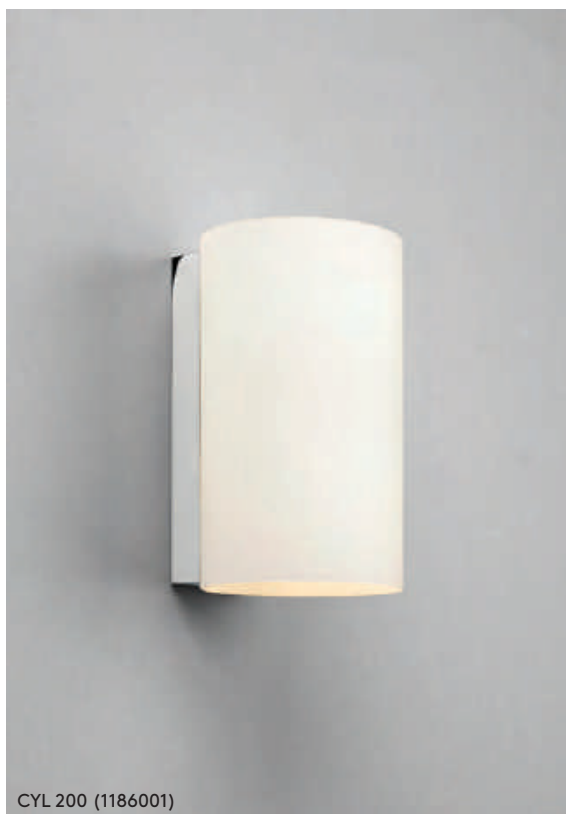

CYL 200 (1186001)



CYL 260 (1186002)

WG

CYL

| | | LAMP | WATT | CLASS | | |
|-----|---------|----------|-------------|-------|---|---|
| 200 | 1186001 | E14 LED▼ | 2 x 7W max | | ✓ | ✓ |
| 260 | 1186002 | E27 LED▼ | 2 x 12W max | | ✓ | ✓ |

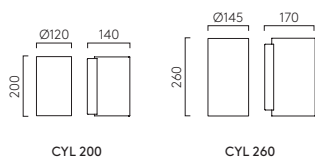

▼ Lamp excluded, see page 714 / La lampe exclu, voir page 714 / La lampadina esclusi a pagina 714 / Das Leuchtmittel ist ausgeschlossen, sie auf Seite 714.





LUGA (1074001)



OBROUND (1072001)

WG

LUGA

WG 1074001

| LAMP | WATT | CLASS | | | |
|---------|--------|-------|---|---|---|
| E14 LED | 7W max | | ✓ | ✓ | ✓ |

OBROUND

WG 1072001

| LAMP | WATT | CLASS | | |
|---------|--------|-------|---|---|
| E14 LED | 7W max | | ✓ | ✓ |

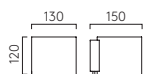

LUGA



OBROUND

▼ Lamp excluded, see page 714 / La lampe exclu, voir page 714 / La lampadina esclusi a pagina 714 / Das Leuchtmittel ist ausgeschlossen, sie auf Seite 714.





TOKYO (1089001)

WG

TOKYO

| | LAMP | WATT | CLASS | | | |
|-----------------|------------------------|---------|-------|---|---|---|
| CLASSIC | WG 1089001 E14 LED▼ | 7W max | | ✓ | - | ✓ |
| | WG 1089004 E27 LED▼ | 12W max | | ✓ | - | ✓ |
| SWITCHED | WG 1089002 E14 LED▼ | 7W max | | ✓ | ✓ | ✓ |

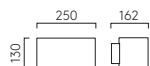

TOKYO / TOKYO SWITCHED

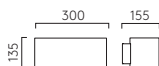

TOKYO CLASSIC

▼ Lamp excluded, see page 714 / La lampe exclu, voir page 714 / La lampadina esclusi a pagina 714 / Das Leuchtmittel ist ausgeschlossen, sie auf Seite 714.

LED

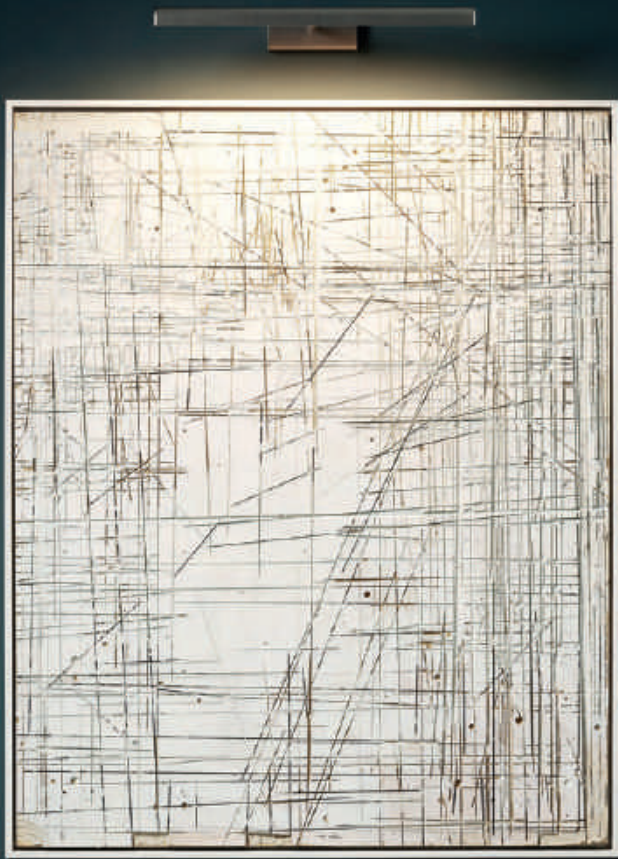

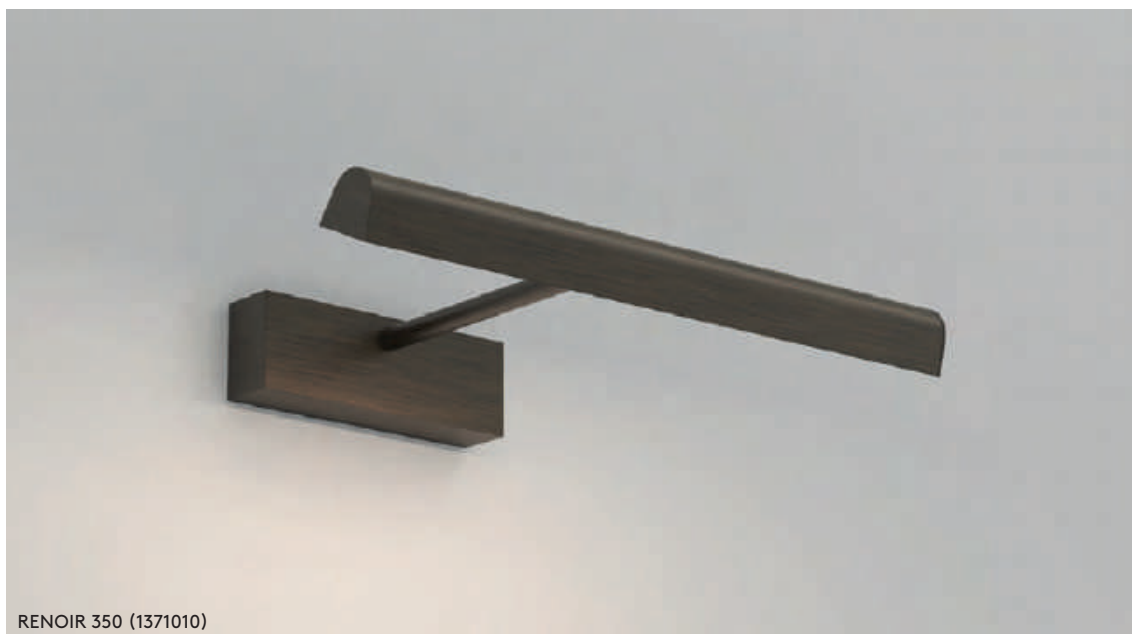

RENOIR 350 (1371010)



RENOIR

| | MN | | Br | | LAMP | WATT | INPUT | K | CRI | Lm | CLASS | |
|-----|----|---------|----|---------|--------------|------|------------|------|-----|-----|-------|---|
| 350 | MN | 1371009 | Br | 1371010 | Integral LED | 3.8W | Mains 230V | 2700 | 80 | 190 | ⊕ | ✓ |
| 520 | MN | 1371012 | Br | 1371013 | Integral LED | 4.8W | Mains 230V | 2700 | 80 | 261 | ⊕ | ✓ |
| 680 | MN | 1371015 | Br | 1371016 | Integral LED | 6.3W | Mains 230V | 2700 | 80 | 367 | ⊕ | ✓ |



RENOIR 350

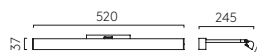

RENOIR 520

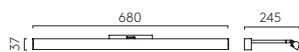

RENOIR 680

LED





MONDRIAN FRAME MOUNTED 300 (1374003)



MONDRIAN FRAME MOUNTED

| | | | | LAMP | WATT | INPUT | K | CRI | Lm | CLASS | |
|-----|---------|---------|--|--------------|------|---------|------|-----|-----|-------|---|
| 300 | 1374011 | 1374003 | | Integral LED | 3.6W | 12V CV▼ | 2700 | 80 | 112 | | ✓ |
| 400 | 1374007 | 1374017 | | Integral LED | 4.6W | 12V CV▼ | 2700 | 80 | 161 | | ✓ |
| 600 | 1374006 | 1374015 | | Integral LED | 8.1W | 12V CV▼ | 2700 | 80 | 219 | | ✓ |

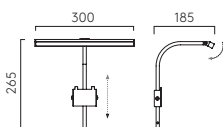

MONDRIAN FRAME MOUNTED 300

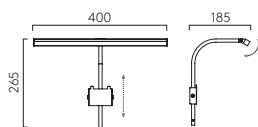

MONDRIAN FRAME MOUNTED 400

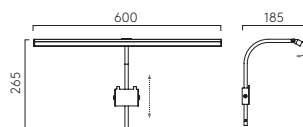

MONDRIAN FRAME MOUNTED 600

Can be frame-mounted or wall mounted / Peut être monté sur le cadre ou le mur / Kann auf dem Rahmen oder an der Wand montiert werden / Può essere montato a un quadro o a una parete

For wall mounted only Mondrian, please refer to next page ►

▼ Driver excluded, see page 714. Driver d'entrée exclu, voir page 714. / Driver esclusi a pagina 714. / Das treiber ist ausgeschlossen, sie auf Seite 714.

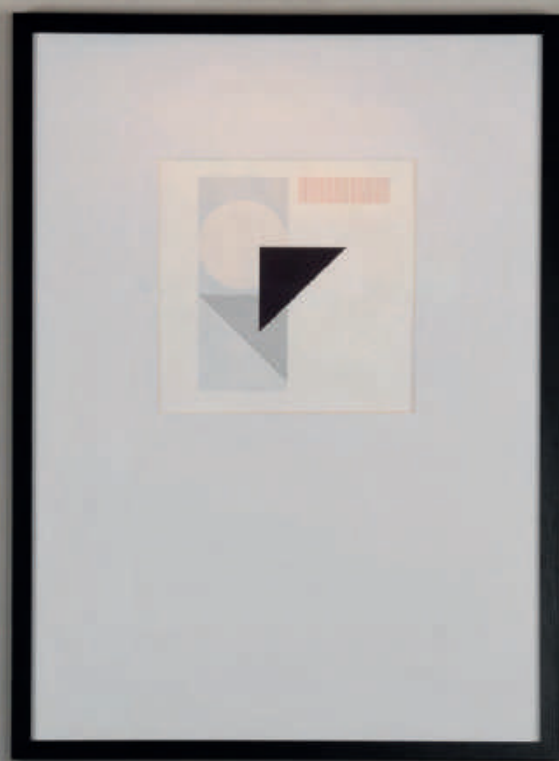
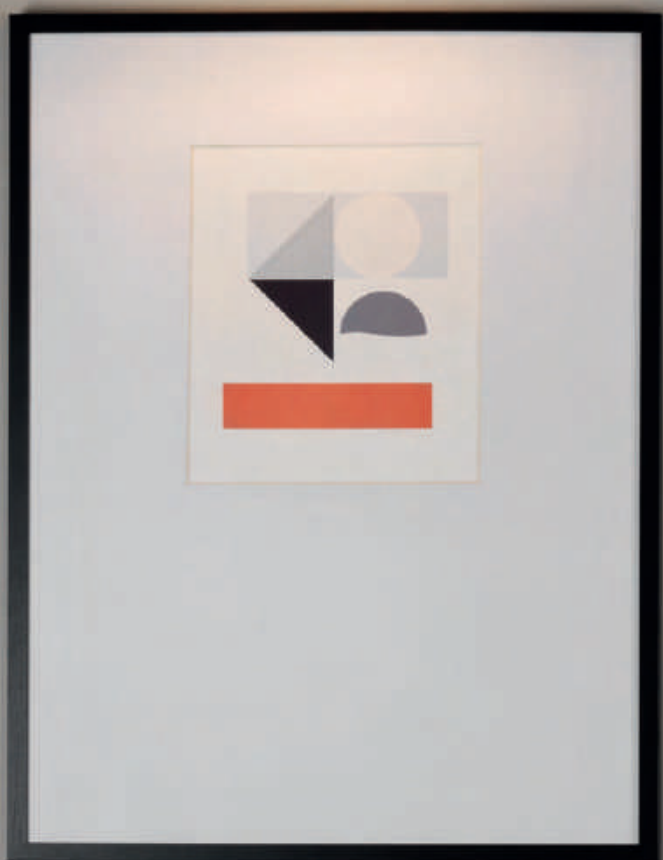

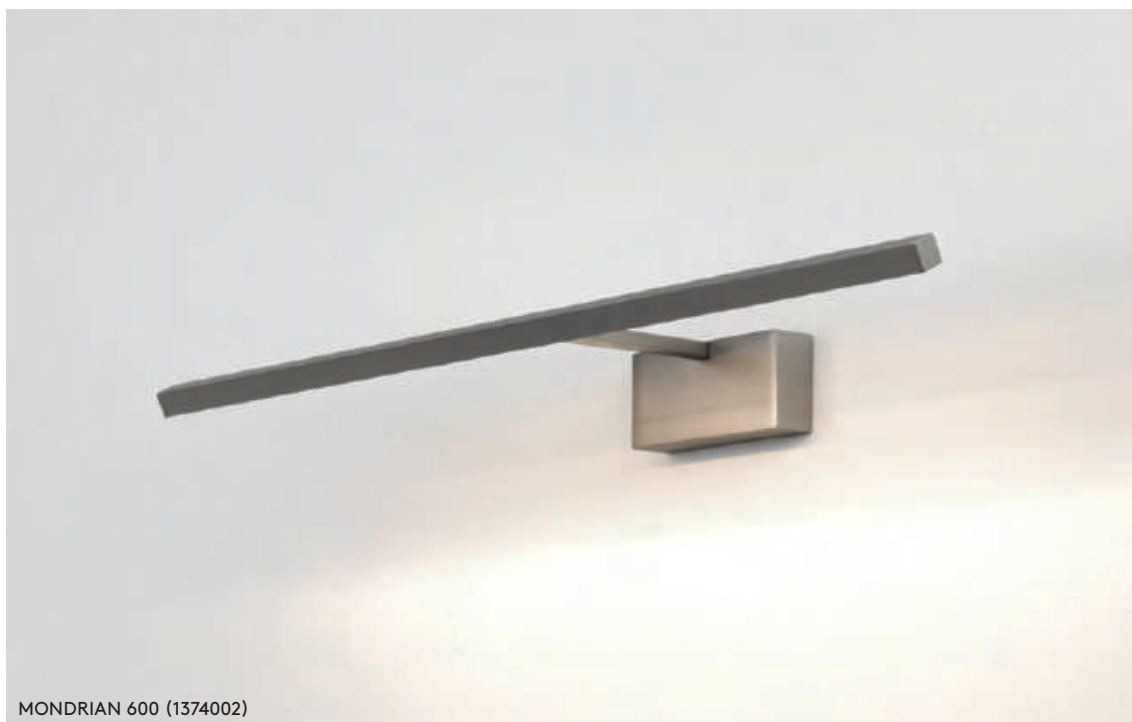

MONDRIAN 600 (1374002)



MONDRIAN

| | | | | LAMP | WATT | INPUT | K | CRI | Lm | CLASS |
|------------|-------------------|-------------------|--|--------------|-------|------------|------|-----|-----|-------|
| 300 | MN 1374012 | Br 1374016 | | Integral LED | 5.1W | Mains 230V | 2700 | 80 | 112 | ⊕ |
| 400 | MN 1374001 | Br 1374018 | | Integral LED | 6.9W | Mains 230V | 2700 | 80 | 161 | ⊕ |
| 600 | MN 1374002 | Br 1374019 | | Integral LED | 10.8W | Mains 230V | 2700 | 80 | 219 | ⊕ |

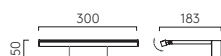

MONDRIAN 300



MONDRIAN 400

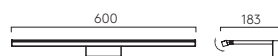

MONDRIAN 600

◀ For frame mounted Mondrian, please refer to previous page.





GOYA 760 LED (1115010)

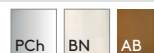

GOYA

| | | | | | LAMP | WATT | INPUT | K | CRI | Lm | CLASS | |
|----------------|---------|---------|---------|--|--------------|------|------------|------|-----|------|-------|---|
| 460 LED | 1115007 | 1115012 | 1115008 | | Integral LED | 7.5W | Mains 230V | 2700 | 80 | 821 | | ✓ |
| 760 LED | 1115009 | 1115013 | 1115010 | | Integral LED | 9.6W | Mains 230V | 2700 | 80 | 1109 | | ✓ |

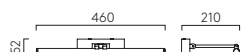

GOYA 460 LED

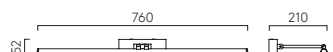

GOYA 760 LED

MARKER

FEUX DE POSITION / MARKLIGHTS / FRECCE



BORG COLLECTION

| | | | | | |
|------------|--------|----------------------|--------|-----------------------|--------|
| 1. BORG 54 | P. 403 | 4. BORG 55 | P. 403 | 7. BORG TRIMLESS 98 | P. 401 |
| 2. BORG 90 | P. 403 | 5. BORG TRIMLESS 200 | P. 401 | 8. BORG TRIMLESS 35 | P. 401 |
| 3. BORG 43 | P. 403 | 6. BORG TRIMLESS 65 | P. 401 | 9. BORG TRIMLESS MINI | P. 401 |



LED





LEROS TRIMLESS (1342002)



OLYMPUS TRIMLESS (1343002)



LEROS TRIMLESS

| | LAMP | WATT | INPUT | K | CRI | Lm | CLASS | | |
|------------|--------------|------|-----------|------|-----|----|-------|---|---|
| MW 1342002 | Integral LED | 1W | 350mA CC▼ | 2700 | 80 | 36 | | ✓ | ✓ |

OLYMPUS TRIMLESS

| | LAMP | WATT | INPUT | K | CRI | Lm | CLASS | | |
|------------|--------------|------|-----------|------|-----|----|-------|---|---|
| MW 1343002 | Integral LED | 1W | 350mA CC▼ | 2700 | 90 | 47 | | ✓ | ✓ |

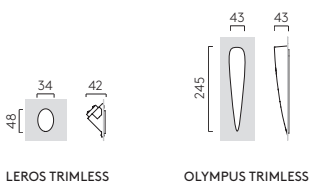

LEROS TRIMLESS

OLYMPUS TRIMLESS

Driver must be installed remotely in a serviceable location.
 / Le driver doit être installé à distance dans un endroit accessible / Treiber muss remote in einem zu wart Speicherort installiert. / Driver deve essere installato a distanza in un luogo accessibile.

▼ Driver excluded, see page 714 / Driver d'entrée exclu, voir page 714 / Driver esclusi a pagina 714 / Das treiber ist ausgeschlossen / Sie auf Seite 714.

LED



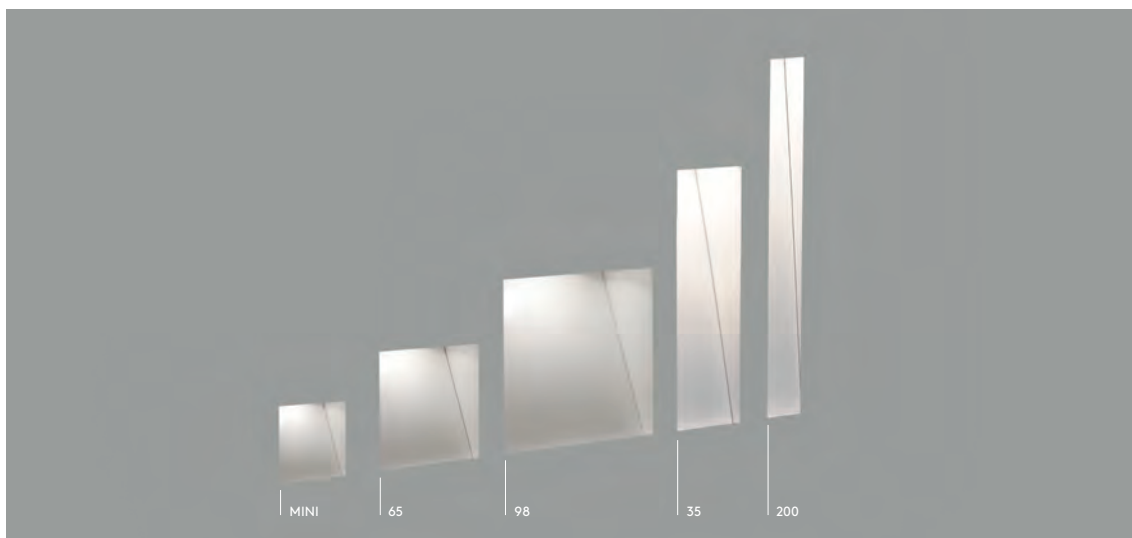

BORG TRIMLESS

| | | | LAMP | WATT | INPUT | K | CRI | Lm | CLASS | 🔌 |
|-------------|---------|--|--------------|------|-----------|------|-----|----|-------|---|
| MINI | 1212039 | | Integral LED | 1W | 350mA CC▼ | 3000 | 90 | 22 | ⬢ | ✓ |
| | 1212037 | | Integral LED | 1W | 350mA CC▼ | 2700 | 90 | 29 | ⬢ | ✓ |
| 35 | 1212007 | | Integral LED | 2W | 700mA CC▼ | 3000 | 90 | 70 | ⬢ | ✓ |
| | 1212027 | | Integral LED | 2W | 700mA CC▼ | 2700 | 90 | 76 | ⬢ | ✓ |
| 65 | 1212008 | | Integral LED | 2W | 700mA CC▼ | 3000 | 90 | 80 | ⬢ | ✓ |
| | 1212028 | | Integral LED | 2W | 700mA CC▼ | 2700 | 90 | 70 | ⬢ | ✓ |
| 98 | 1212041 | | Integral LED | 2W | 700mA CC▼ | 3000 | 90 | 84 | ⬢ | ✓ |
| | 1212042 | | Integral LED | 2W | 700mA CC▼ | 2700 | 90 | 77 | ⬢ | ✓ |
| 200 | 1212038 | | Integral LED | 2W | 700mA CC▼ | 3000 | 90 | 56 | ⬢ | ✓ |
| | 1212040 | | Integral LED | 2W | 700mA CC▼ | 2700 | 90 | 46 | ⬢ | ✓ |

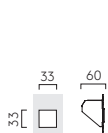

BORG TRIMLESS MINI

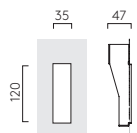

BORG TRIMLESS 35

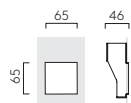

BORG TRIMLESS 65

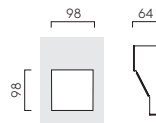

BORG TRIMLESS 98

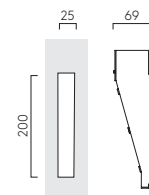

BORG TRIMLESS 200

BORG 35, 65, 98 AND 200:
6008001 and 6008051 drivers can be accessed after installation / Les drivers 6008001 et 6008051 sont accessibles après l'installation / Die Treiber 6008001 und 6008051 sind nach der Montage zugänglich / 6008001 e 6008051 driver sono accessibili dopo l'installazione.



BORG MINI:
Driver must be installed remotely in a serviceable location. / Le driver doit être installé à distance dans un endroit accessible / Treiber muss remote in einem zu wart Speicherort installiert / Driver deve essere installato a distanza in un luogo accessibile.

▼ Driver excluded, see page 714 / Driver d'entrée exclu, voir page 714 / Driver esclusi a pagina 714 / Das treiber ist ausgeschlossen, Sie auf Seite 714.

LED



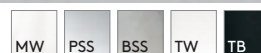
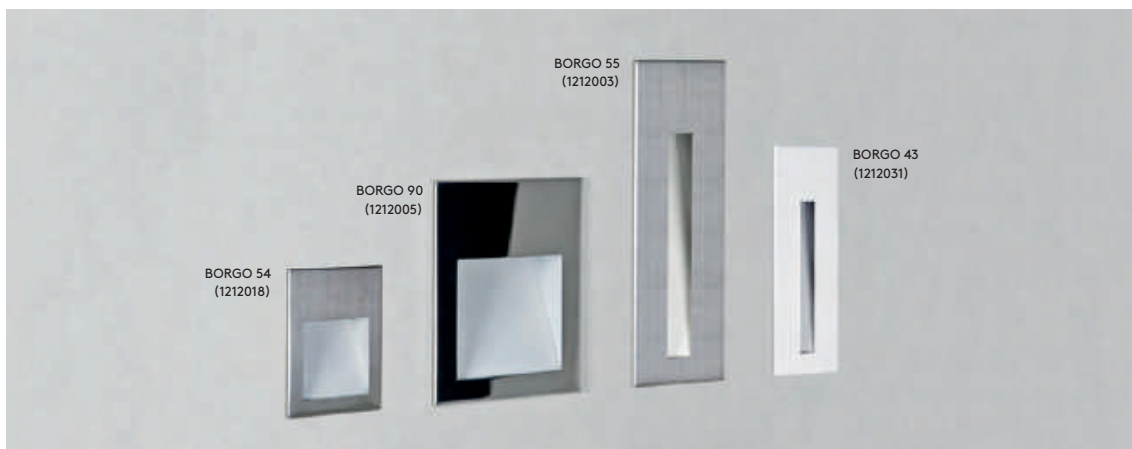

BORGEO

| | | | | | LAMP | WATT | INPUT | K | CRI | Lm | CLASS | Ⓢ | Ⓡ | Ⓢ | | | |
|----|-----|---------|---------|---------|---------|---------|--------------|--------------|--------------|-----------|------------|------|----|-----|---|---|---|
| 43 | PSS | 1212015 | MW | 1212017 | BSS | 1212016 | Integral LED | 1W | 350mA CC▼ | 3000 | 90 | 15 | Ⓢ | ✓ | ✓ | ✓ | |
| | PSS | 1212029 | MW | 1212031 | BSS | 1212030 | Integral LED | 1W | 350mA CC▼ | 2700 | 90 | 12 | Ⓢ | ✓ | ✓ | ✓ | |
| | 54 | PSS | 1212020 | MW | 1212019 | BSS | 1212018 | Integral LED | 1W | 350mA CC▼ | 3000 | 90 | 30 | Ⓢ | ✓ | ✓ | ✓ |
| | PSS | 1212034 | MW | 1212033 | BSS | 1212032 | Integral LED | 1W | 350mA CC▼ | 2700 | 90 | 30 | Ⓢ | ✓ | ✓ | ✓ | |
| 55 | PSS | 1212002 | MW | 1212001 | BSS | 1212003 | Integral LED | 2W | 700mA CC▼ | 3000 | 90 | 39 | Ⓢ | ✓ | ✓ | ✓ | |
| | PSS | 1212022 | MW | 1212021 | BSS | 1212023 | Integral LED | 2W | 700mA CC▼ | 2700 | 90 | 40 | Ⓢ | ✓ | ✓ | ✓ | |
| | NEW | 55MV | PSS | 1212043 | MW | 1212045 | BSS | 1212044 | Integral LED | 4.1W | Mains 230V | 3000 | 80 | 48 | Ⓢ | ✓ | ✓ |
| | | | TW | 1212050 | TB | 1212049 | | | | | | | | | | | |
| 90 | PSS | 1212005 | MW | 1212004 | BSS | 1212006 | Integral LED | 2W | 700mA CC▼ | 3000 | 90 | 72 | Ⓢ | ✓ | ✓ | ✓ | |
| | PSS | 1212025 | MW | 1212024 | BSS | 1212026 | Integral LED | 2W | 700mA CC▼ | 2700 | 90 | 68 | Ⓢ | ✓ | ✓ | ✓ | |
| | NEW | 90MV | PSS | 1212046 | MW | 1212048 | BSS | 1212047 | Integral LED | 4.1W | Mains 230V | 3000 | 80 | 124 | Ⓢ | ✓ | ✓ |
| | | | TW | 1212052 | TB | 1212051 | | | | | | | | | | | |

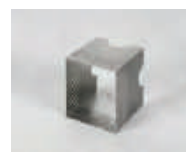
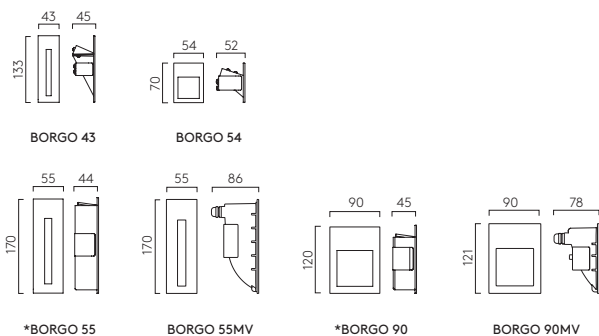

90 WALL BOX 6013002
H.108mm W.87mm D.100mm



55 WALL BOX 6013001
H.165mm W.51mm ø.100mm

* A wall box accessory is available for installation of the Borgeo 55 and 90 into brick walls / Accessoire mural disponible pour l'installation de la gamme Borgeo dans des murs en brique / Als Zubehör sind Wandkästen erhältlich, die eine Installation der Borgeo Serie in Ziegelwänden ermöglichen. / Un accessorio per le pareti è disponibile per l'installazione del Borgeo in muri di mattoni.

LED Driver accessible after installation / Driver LED accessibles après installation / LED-Treiber ist nach der Installation zugänglich / Accesso al driver anche dopo l'installazione



▼ Driver excluded, see page 714 / Driver d'entrée exclu, voir page 714 / Driver esclusi a pagina 714 / Das treiber ist ausgeschlossen, sie auf Seite 714.

LED





TANGO (1175005)

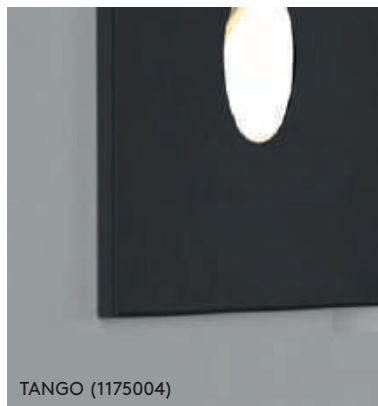

TANGO (1175004)



TANGO (1175002)



TANGO

| BSS | 1175002 | PSS | 1175005 | LAMP | WATT | INPUT | K | CRI | Lm | CLASS | ☾ | 🌐 |
|-----|---------|-----|---------|--------------|------|------------|------|-----|----|-------|---|---|
| BSS | 1175007 | PSS | 1175010 | Integral LED | 1W | 350mA CC ▼ | 3000 | 90 | 23 | ⬇ | ✓ | ✓ |
| MW | 1175001 | TB | 1175004 | Integral LED | 1W | 350mA CC ▼ | 2700 | 90 | 29 | ⬇ | ✓ | ✓ |
| MW | 1175006 | TB | 1175009 | Integral LED | 1W | 350mA CC ▼ | 3000 | 90 | 23 | ⬇ | ✓ | ✓ |
| | | | | Integral LED | 1W | 350mA CC ▼ | 2700 | 90 | 29 | ⬇ | ✓ | ✓ |

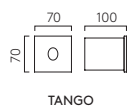

▼ Driver excluded, see page 714 / Driver d'entrée exclu, voir page 714 / Driver esclusi a pagina 714 / Das treiber ist ausgeschlossen / Sie auf Seite 714.



TABLE & FLOOR

LAMPADAIRES TABLE ET SOL · TISCH-UND STEHLEUCHTEN · LAMPADE DA TAVOLO E DA TERRA



NEW
FOLD TABLE
P. 409



NEW
FOLD FLOOR
P. 411



NEW
ASCOLI DESK
P. 413



NEW
ASCOLI FLOOR
P. 415



NEW
ENNA DESK
P. 417



NEW
ENNA FLOOR
P. 419



ATELIER CLAMP
P. 421



ATELIER DESK
P. 421



ATELIER FLOOR
P. 423



JOEL TABLE
P. 424



JOEL GRANDE TABLE
P. 425



JOEL FLOOR
P. 427



TELEGRAPH TABLE
P. 429



TELEGRAPH FLOOR
P. 429



RAVELLO TABLE
P. 431



RAVELLO FLOOR
P. 433



AZUMI TABLE
P. 434



AZUMI FLOOR
P. 435



PARK LANE TABLE
P. 436



PARK LANE FLOOR
P. 437



CUT
P. 439



MARTELLO 180
P. 441



MARTELLO 240
P. 441



MARASINO
P. 443



LIMINA
P. 443

LED





FOLD TABLE (1408006)



FOLD TABLE (1408004)



NEW

FOLD TABLE

| | LAMP | WATT | INPUT | K | CRI | Lm | CLASS | |
|--------------------------------------|--------------|------|------------|------|-----|-----|-------|---|
| MW 1408004 MB 1408005 MN 1408006 | Integral LED | 4.7W | Mains 230V | 2700 | 90 | 151 | □ | ✓ |

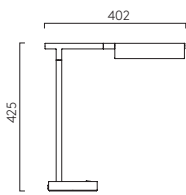

FOLD TABLE

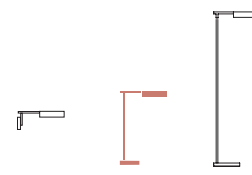

P. 307

P. 409

P. 411

LED





FOLD FLOOR (1408009)

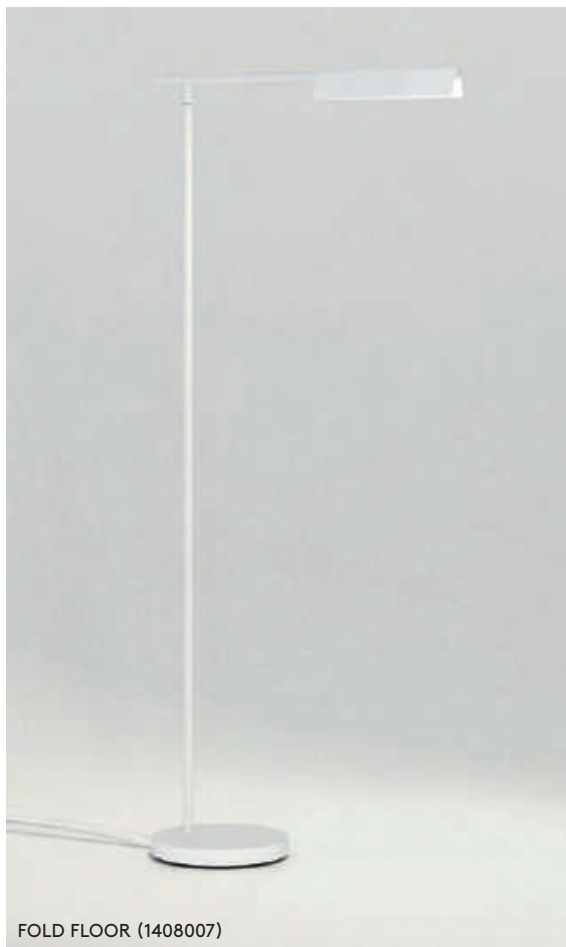

FOLD FLOOR (1408007)



NEW

FOLD FLOOR

| | LAMP | WATT | INPUT | K | CRI | Lm | CLASS | |
|------------|--------------|------|------------|------|-----|-----|-------|---|
| MW 1408007 | Integral LED | 8.1W | Mains 230V | 2700 | 90 | 324 | □ | ✓ |
| MB 1408008 | | | | | | | | |
| MN 1408009 | | | | | | | | |

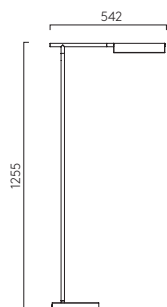

FOLD FLOOR

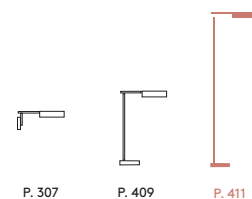





ASCOLI DESK (1286024)

ASCOLI DESK (1286017)

ASCOLI DESK (1286086)



ASCOLI DESK

NEW

- MW 1286016
- MN 1286017
- Br 1286024
- MB 1286086

| LAMP | WATT | CLASS | |
|-----------|--------|-------|--|
| GU10 LED▼ | 6W max | | |

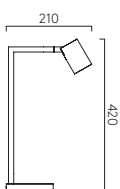

ASCOLI DESK

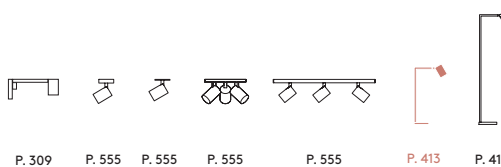

▼ Lamp excluded, see page 714 / La lampe exclu, voir page 714 / La lampadina esclusi a pagina 714 / Das Leuchtmittel ist ausgeschlossen, sie auf Seite 714.





ASCOLI FLOOR (1286019)



ASCOLI FLOOR (1286025)



ASCOLI FLOOR

| | LAMP | WATT | CLASS | |
|------------|-----------------------|------------|--------------------------|-------------------------------------|
| NEW | MW 1286018 | MN 1286019 | Br 1286025 | MB 1286087 |
| | GU10 LED [▼] | 6W max | <input type="checkbox"/> | <input checked="" type="checkbox"/> |

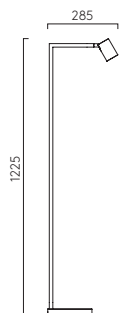

ASCOLI FLOOR

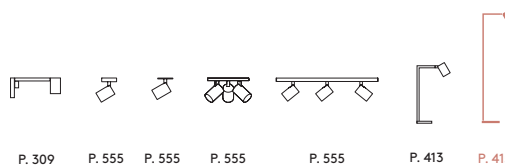

▼ Lamp excluded, see page 714 / La lampe exclu, voir page 714 / La lampadina esclusi a pagina 714 / Das Leuchtmittel ist ausgeschlossen, sie auf Seite 714.

LED





ENNA DESK

| | LAMP | WATT | INPUT | K | CRI | Lm | CLASS |
|---|--------------|------|------------|------|-----|-----|--|
| MW 1058005 MB 1058006 MN 1058057 MG 1058106 | Integral LED | 4.5W | Mains 230V | 2700 | 90 | 124 | <input type="checkbox"/> <input checked="" type="checkbox"/> |

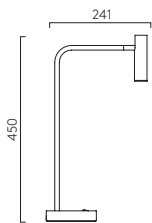

ENNA DESK



P. 315



P. 317



P. 313



P. 311



P. 417



P. 419

LED





ENNA FLOOR (1058002)



ENNA FLOOR (1058003)



ENNA FLOOR

| | LAMP | WATT | INPUT | K | CRI | Lm | CLASS | |
|---|--------------|------|------------|------|-----|-----|--------------------------|-------------------------------------|
| MW 1058002 MB 1058003 MN 1058058 MG 1058107 | Integral LED | 4.5W | Mains 230V | 2700 | 90 | 124 | <input type="checkbox"/> | <input checked="" type="checkbox"/> |



ENNA FLOOR

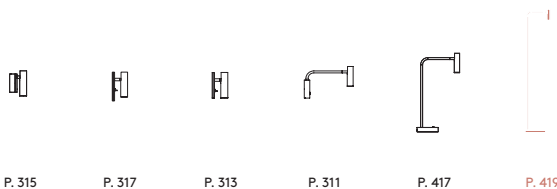





ATELIER ARM ASSEMBLY + DESK (1224001 + 1224004)



ATELIER ARM ASSEMBLY + CLAMP (1224003 + 1224010)



ATELIER

| | PA | MW | MB | LAMP | WATT | CLASS | I |
|---------------------|---------|---------|---------|----------|---------|-------|---|
| ARM ASSEMBLY | 1224001 | 1224002 | 1224003 | E27 LED▼ | 12W max | □ | ✓ |
| CLAMP | 1224010 | | | - | - | - | - |
| DESK BASE | 1224004 | 1224005 | 1224006 | - | - | - | - |

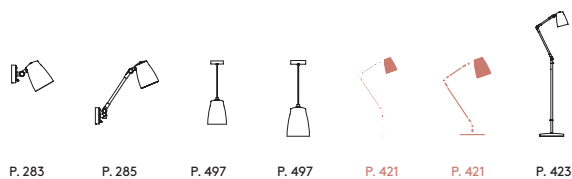
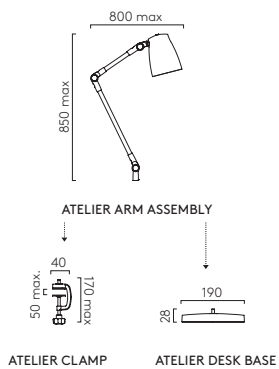

Arm Assembly For use with: En combinaison avec / Zur Verwendung mit / Da installare con: Atelier Clamp (1224010), Atelier Desk Base (1224004,1224005,1224006), Atelier Floor Base (1224007,1224008,1224009).

▼ Lamp excluded, see page 714 / La lampe exclu, voir page 714 / La lampadina esclusi a pagina 714 / Das Leuchtmittel ist ausgeschlossen, sie auf Seite 714.





ATELIER ARM ASSEMBLY + FLOOR BASE (1224001 + 1224007)



ATELIER ARM ASSEMBLY + FLOOR BASE (1224002 + 1224008)



ATELIER

| | PA | MW | MB | LAMP | WATT | CLASS | |
|---------------------|---------|---------|---------|-----------|---------|-------|---|
| ARM ASSEMBLY | 1224001 | 1224002 | 1224003 | E27 LED ▼ | 12W max | | ✓ |
| FLOOR BASE | 1224007 | 1224008 | 1224009 | - | - | - | - |

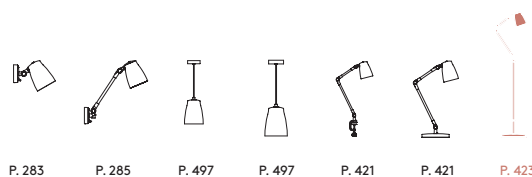
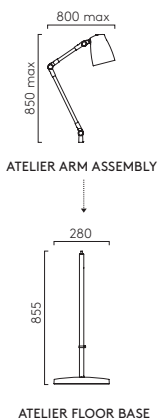

Floor Base for use with / En combinaison avec / Zur Verwendung mit / Da installare con: Atelier Arm Assembly (1224001,1224002,1224003).

▼ Lamp excluded, see page 714 / La lampe exclu, voir page 714 / La lampadina esclusi a pagina 714 / Das Leuchtmittel ist ausgeschlossen, sie auf Seite 714.



JOEL TABLE (1223002)



JOEL TABLE (1223003)



JOEL TABLE

| | LAMP | WATT | CLASS | |
|-------------------|----------|---------|-------|-------------------------------------|
| MB 1223002 | E27 LED▼ | 12W max | | <input checked="" type="checkbox"/> |
| Cr 1223003 | | | | |

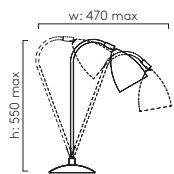

JOEL TABLE

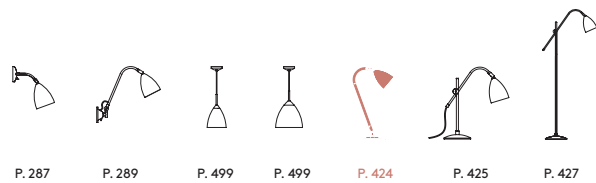

▼ Lamp excluded, see page 714 / La lampe exclu, voir page 714 / La lampadina esclusi a pagina 714 / Das Leuchtmittel ist ausgeschlossen, sie auf Seite 714.



JOEL GRANDE TABLE (1223010)

MB Cr

JOEL GRANDE TABLE

| | LAMP | WATT | CLASS | |
|------------|---------|---------|-------|---|
| MB 1223011 | E27 LED | 12W max | | |
| Cr 1223010 | | | | ✓ |

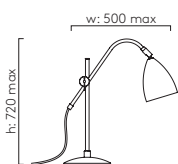

JOEL GRANDE TABLE

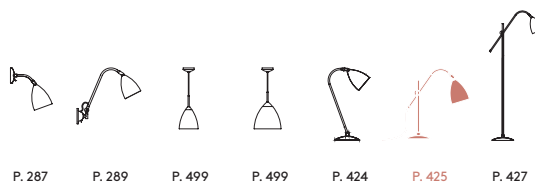

▼ Lamp excluded, see page 714 / La lampe exclu, voir page 714 / La lampadina esclusi a pagina 714 / Das Leuchtmittel ist ausgeschlossen, sie auf Seite 714.





JOEL FLOOR (1223006)



JOEL FLOOR (1223005)

MB Cr

JOEL FLOOR

| | LAMP | WATT | CLASS | |
|------------|---------|---------|-------|---|
| MB 1223005 | E27 LED | 12W max | | ✓ |
| Cr 1223006 | | | | |

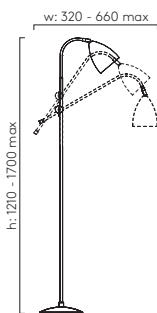

JOEL FLOOR

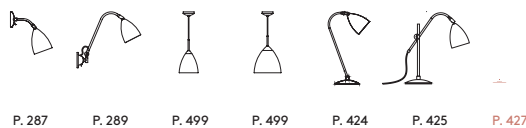

▼ Lamp excluded, see page 714 / La lampe exclu, voir page 714 / La lampadina esclusi a pagina 714 / Das Leuchtmittel ist ausgeschlossen, sie auf Seite 714.





TELEGRAPH TABLE (1404006)



TELEGRAPH FLOOR (1404007)

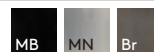

TELEGRAPH

SHADE EXCLUDED

| | MB | MN | Br | LAMP | WATT | CLASS | |
|-------|---------|---------|---------|----------|---------|-------|---|
| TABLE | 1404004 | 1404005 | 1404006 | E27 LED▼ | 12W max | | ✓ |
| FLOOR | 1404007 | 1404008 | 1404009 | E27 LED▼ | 12W max | | ✓ |

TAPERED ROUND 330

W. 330 D. 377

- WF 5035006
- BF 5035007
- OF —
- PF 5035008
- MF 5035024

TELEGRAPH TABLE

TAPERED ROUND 440

W. 440 D. 498

- WF 5009003
- BF 5009004
- OF 5012002
- PF 5009006
- MF 5035012

TELEGRAPH FLOOR

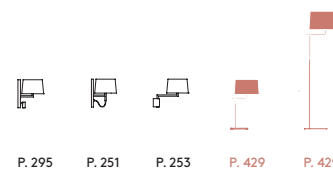

● P. 716: Special Shade Colours / Couleurs spéciales / Sonderfarben / Colori speciali

▼ Lamp excluded, see page 714 / La lampe exclu, voir page 714 / La lampadina esclusi a pagina 714 / Das Leuchtmittel ist ausgeschlossen, sie auf Seite 714.





RAVELLO TABLE (1222007 + 5016007)



RAVELLO TABLE (1222008 + 5030009)



RAVELLO TABLE

SHADE EXCLUDED

| | | | LAMP | WATT | CLASS | | | | |
|-----|---------|----|---------|------|---------|---------|---------|--------------------------|-------------------------------------|
| PCh | 1222007 | MN | 1222008 | Br | 1222009 | E27 LED | 12W max | <input type="checkbox"/> | <input checked="" type="checkbox"/> |

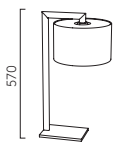

W. 250 D. 305

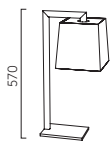

W. 195 D. 285

DRUM 250

- WF 5016007
- BF 5016008
- OF 5016009
- PF 5016019
- MF 5016078

TAPERED SQUARE 195

- WF 5030008
- BF 5030007
- OF 5030009
- PF 5030010
- MF -

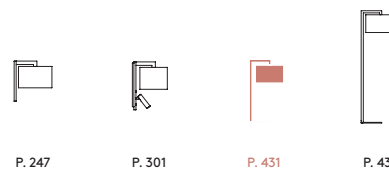

P. 716: Special Shade Colours / Couleurs spéciales / Sonderfarben / Colori speciali

▼ Lamp excluded, see page 714 / La lampe exclu, voir page 714 / La lampadina esclusi a pagina 714 / Das Leuchtmittel ist ausgeschlossen, sie auf Seite 714.





RAVELLO FLOOR (1222003 + 5016004)



RAVELLO FLOOR (1222001 + 5030013)



RAVELLO FLOOR

SHADE EXCLUDED

| | LAMP | WATT | CLASS | |
|--|----------|---------|--------------------------|-------------------------------------|
| PCh 1222001 MN 1222002 Br 1222003 | E27 LED▼ | 12W max | <input type="checkbox"/> | <input checked="" type="checkbox"/> |

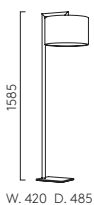

DRUM 420

- WF 5016004
- BF 5016005
- OF 5016006
- PF 5016028
- MF 5016077

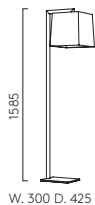

TAPERED SQUARE 300

- WF 5030012
- BF 5030011
- OF 5030013
- PF 5030014
- MF —



P. 247



P. 301



P. 431



P. 433

P. 716: Special Shade Colours / Couleurs spéciales / Sonderfarben / Colori speciali

▼ Lamp excluded, see page 714 / La lampe exclu, voir page 714 / La lampadina esclusi a pagina 714 / Das Leuchtmittel ist ausgeschlossen, sie auf Seite 714.



AZUMI TABLE (1142022 + 5003001)

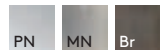

AZUMI TABLE

SHADE EXCLUDED

LAMP WATT CLASS

PN 1142018 MN 1142022 Br 1142045

E27 LED 12W max

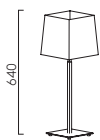

W. 210 D. 210

TAPERED SQUARE 210

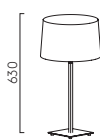

Ø 320

TAPERED ROUND 320

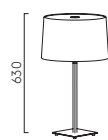

Ø 330

TAPERED ROUND 330

WF 5003001
BF —
OF —
PF —
MF —

WF 5009001
BF —
OF 5012001
PF 5009005
MF 5035013

WF 5035006
BF 5035007
OF —
PF 5035008
MF 5035024

 P. 716: Special Shade Colours Couleurs / spéciales / Sonderfarben / Colori speciali

▼ Lamp excluded, see page 714 / La lampe exclu, voir page 714 / La lampadina esclusi a pagina 714 / Das Leuchtmittel ist ausgeschlossen, sie auf Seite 714.



AZUMI TABLE (1142022 + 5003001) + AZUMI FLOOR (1142023 + 5003003)

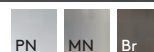

AZUMI FLOOR

SHADE EXCLUDED

| | LAMP | WATT | CLASS | |
|------------|-----------|---------|--------------------------|-------------------------------------|
| PN 1142020 | E27 LED ▼ | 12W max | <input type="checkbox"/> | <input checked="" type="checkbox"/> |

MN 1142023 Br 1142046

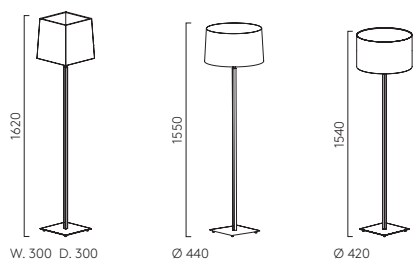

| WF | BF | OF | PF | MF |
|---------|---------|---------|---------|---------|
| 5003003 | - | - | - | - |
| 5009003 | 5009004 | 5012002 | 5009006 | 5035012 |
| 5016004 | 5016005 | 5016006 | 5016028 | 5016077 |

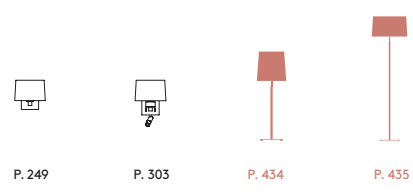

P. 716: Special Shade Colours Couleurs spéciales / Sonderfarben / Colori speciali

▼ Lamp excluded, see page 714 / La lampe exclu, voir page 714 / La lampadina esclusi a pagina 714 / Das Leuchtmittel ist ausgeschlossen, sie auf Seite 714.



PARK LANE TABLE (1080013 + 5001007)



PARK LANE TABLE

SHADE EXCLUDED

| | LAMP | WATT | CLASS | |
|-------------|---------|---------|-------|--|
| PCh 1080013 | E27 LED | 12W max | | |
| MN 1080016 | | | | |
| Br 1080046 | | | | |

RECTANGLE 285

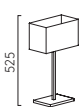

W. 285 D. 170

| | |
|----|---------|
| WF | 5001001 |
| BF | 5001003 |
| OF | 5001007 |
| PF | 5001017 |
| MF | 5011009 |

TAPERED OVAL*



Ø 300

| | |
|----|---------|
| WF | 5034001 |
| BF | 5034002 |
| OF | 5034003 |
| PF | 5034004 |
| MF | — |

P. 716: Special Shade Colours / Couleurs spéciales / Sonderfarben / Colori speciali

▼ Lamp excluded, see page 714 / La lampe exclu, voir page 714 / La lampadina esclusi a pagina 714 / Das Leuchtmittel ist ausgeschlossen, sie auf Seite 714.

* To be used with LED/CFL lamp only / Pour utilisation avec lampe LED/CFL seulement. / nur mit Kompaktleuchtstofflampe/LED verwenden / Solo per l'uso con lampade a LED/CFL



PARK LANE FLOOR (1080047 + 5001002)

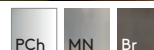

PARK LANE FLOOR

SHADE EXCLUDED

| | PCh | MN | Br | LAMP | WATT | CLASS | |
|--|---------|---------|---------|-----------|---------|-------|---|
| | 1080015 | 1080017 | 1080047 | E27 LED ▼ | 12W max | □ | ✓ |

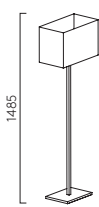

W. 400 D. 225

RECTANGLE 400

- WF 5001002
- BF -
- OF -
- PF 5001030
- MF 5011013

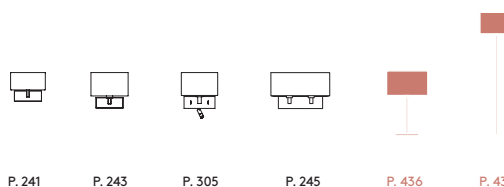

P. 716: Special Shade Colours / Couleurs spéciales / Sonderfarben / Colori speciali

▼ Lamp excluded, see page 714 / La lampe exclu, voir page 714 / La lampadina esclusi a pagina 714 / Das Leuchtmittel ist ausgeschlossen, sie auf Seite 714.



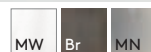

CUT

MW 1412001 Br 1412003 MN 1412002

| LAMP | WATT | CLASS | |
|------------|--------|-------|---|
| GU10 LED ▼ | 6W max | | ✓ |

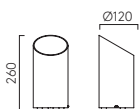

▼ Lamp excluded, see page 714 / La lampe exclu, voir page 714 / La lampadina esclusi a pagina 714 / Das Leuchtmittel ist ausgeschlossen, sie auf Seite 714.





MARTELLO 180 (1395001)



MARTELLO 240 (1395002)



MARTELLO

| | | LAMP | WATT | CLASS | |
|-----|---------|----------|--------|-------|---|
| 180 | 1395001 | E14 LED▼ | 5W max | | ✓ |
| 240 | 1395002 | E27 LED▼ | 7W max | | ✓ |

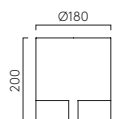

MARTELLO 180

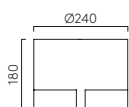

MARTELLO 240



Can be painted / Peut être peint / kann lackiert werden / Può essere verniciato

▼ Lamp excluded, see page 714 / La lampe exclu, voir page 714 / La lampadina esclusi a pagina 714 / Das Leuchtmittel ist ausgeschlossen, sie auf Seite 714.





MARASINO (1218001)



LIMINA (1221001)

P

MARASINO

| | LAMP | WATT | CLASS | |
|-----------|-----------|--------|-------|---|
| P 1218001 | GU10 LED▼ | 6W max | □ | ✓ |

LIMINA

| | LAMP | WATT | CLASS | |
|-----------|-----------|--------|-------|---|
| P 1221001 | GU10 LED▼ | 6W max | □ | ✓ |

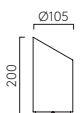

MARASINO

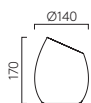

LIMINA



Can be painted / Peut être peint / kann lackiert werden / Può essere verniciato

▼ Lamp excluded, see page 714 / La lampe exclu, voir page 714 / La lampadina esclusi a pagina 714 / Das Leuchtmittel ist ausgeschlossen, sie auf Seite 714.



CEILING

LUMINAIRES DE PLAFOND · DECKENLEUCHTEN · LAMPADE DA SOFFITTO



● **NEW**
CAMBRIA
P. 447



● PLEAT 370
P. 449



SEMI-FLUSH UNIT
P. 451



BEVEL ROUND
P. 453



● ZERO ROUND
P. 455



● ZERO SQUARE
P. 455



● MASHIKO SQUARE
P. 457



● MASHIKO ROUND
P. 459



● **NEW**
TAKETA LED
P. 461



● MALLON
P. 463



● ALTEA
P. 465



● DAKOTA
P. 467



● OSAKA
P. 469



DENIA
P. 469



● SABINA 280
P. 471



SABINA 170
P. 471



SABINA SQUARE
P. 471



● KIWY CEILING
P. 473



ZEPPPO CEILING
P. 475



● MASSA
P. 477



AREZZO CEILING
P. 479



SYROS
P. 481

LED





NEW CAMBRIA

| | WF | PF | WP | LAMP | WATT | CLASS | |
|------------|---------|---------|---------|-----------|---------|-------|---|
| 380 | 1421001 | 1421002 | 1421003 | E27 LED ▼ | 2 x 12W | | ✓ |
| 480 | 1421004 | 1421005 | 1421006 | E27 LED ▼ | 3 x 12W | | ✓ |
| 580 | 1421007 | 1421008 | 1421009 | E27 LED ▼ | 3 x 12W | | ✓ |

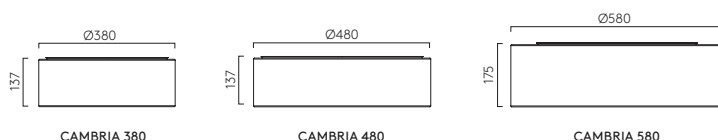

P. 716: Special Shade Colours / Couleurs spéciales / Sonderfarben / Colori speciali

▼ Lamp excluded, see page 714 / La lampe exclu, voir page 714 / La lampadina esclusi a pagina 714 / Das Leuchtmittel ist ausgeschlossen, sie auf Seite 714.

LED





PLEAT 370 + MASSA 300 (5013008 + 1337004)



PLEAT 370

PLEAT 370 SHADE WF 5013007 BF 5013008

Requires / nécessite / erfordert / necessita: Massa 300 LED 1337004

| | LAMP | WATT | INPUT | K | CRI | Lm | IP | CLASS |
|--|--------------|-------|------------|------|-----|------|----|--------------------------|
| MASSA 300 MW 1337004 | Integral LED | 16.4W | Mains 230V | 2700 | 80 | 1311 | 44 | <input type="checkbox"/> |

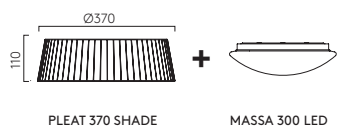

P. 716: Special Shade Colours / Couleurs spéciales / Sonderfarben / Colori speciali





SEMI FLUSH UNIT

SHADE EXCLUDED

| | | | | LAMP | WATT | CLASS | | | | | |
|-----|---------|----|---------|------|---------|-------|---------|---------|---------|---|---|
| PCh | 1362001 | MN | 1362002 | Br | 1362009 | TW | 1362004 | E27 LED | 12W max | ⏻ | ✓ |

| Diagram | Model | Dimensions | WF | BF | OF | PF | MF |
|---------|---------------------------|--------------|---------|---------|---------|---------|---------|
| | DRUM 420 | H. 250 Ø 420 | 5016004 | 5016005 | 5016006 | 5016028 | 5016077 |
| | DRUM 500 | H. 250 Ø 500 | 5016010 | 5016011 | 5016012 | - | - |
| | DRUM 400 PLEATED | H. 230 Ø 400 | 5016013 | 5016014 | - | 5016015 | - |
| | DRUM 500 PLEATED | H. 230 Ø 500 | 5016016 | 5016017 | - | 5016018 | - |
| | TAPERED ROUND 400 PLEATED | H. 230 Ø 400 | 5002009 | - | - | 5002010 | - |

P. 716: Special Shade Colours / Couleurs spéciales / Sonderfarben / Colori speciali

▼ Lamp excluded, see page 714 / La lampe exclu, voir page 714 / La lampadina esclusi a pagina 714 / Das Leuchtmittel ist ausgeschlossen, sie auf Seite 714.





BEVEL ROUND 450 (5021003 + 1296001)



BEVEL ROUND

| | | | CEILING PLATE EXCL. | LAMP | WATT | CLASS | |
|-----|---------|---------|----------------------|-----------|---------|-------|---|
| 450 | 5021003 | 5021011 | 3-way plate: 1296001 | E27 LED ▼ | 12W max | | ✓ |
| 600 | 5021001 | 5021009 | 4-way plate: 1296002 | E27 LED ▼ | 12W max | | ✓ |

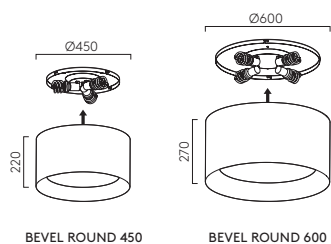

▼ Lamp excluded, see page 714 / La lampe exclu, voir page 714 / La lampadina esclusi a pagina 714 / Das Leuchtmittel ist ausgeschlossen, sie auf Seite 714.

LED





ZERO

| | | LAMP | WATT | INPUT | K | CRI | Lm | CLASS |
|---------------|---------|--------------|-------|------------|------|-----|-----|-------|
| ROUND | 1382002 | Integral LED | 16.6W | Mains 230V | 2700 | 80 | 810 | |
| SQUARE | 1382001 | Integral LED | 15.4W | Mains 230V | 2700 | 80 | 807 | |

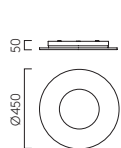

ZERO ROUND

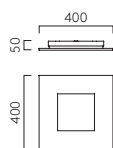

ZERO SQUARE

LED





MASHIKO SQUARE 400 (1121010)



MASHIKO SQUARE 200 (1121009)



MASHIKO SQUARE

| | | | LAMP | WATT | INPUT | K | CRI | Lm | IP | CLASS | | | |
|--------------------|---------------------------|--|--------------|-------------|------------|------|-----|------|----|-------|---|---|---|
| 200 | 1121009 1121056 | | E27 LED ▼ | 12W max | - | - | - | - | 44 | | ✓ | ✓ | - |
| CLASSIC 300 | 1121005 | | E27 LED ▼ | 2 x 12W max | - | - | - | - | 44 | | ✓ | ✓ | - |
| 300 LED | 1121040 1121062 1121071 | | Integral LED | 16W | Mains 230V | 2700 | 80 | 981 | 44 | | - | ✓ | ✓ |
| 400 | 1121010 1121013 | | E27 LED ▼ | 4 x 12W max | - | - | - | - | 44 | | ✓ | ✓ | - |
| 400 LED | 1121067 1121069 | | Integral LED | 27.4W | Mains 230V | 3000 | 80 | 2458 | 44 | | ✓ | ✓ | ✓ |

EMERGENCY

| | | | | | | | | | | | | | |
|-------------------------|------------------|--|--------------|-------|------------|------|----|------|----|--|---|---|---|
| 400 LED basic | 1121075 1121076 | | Integral LED | 31.2W | Mains 230V | 3000 | 80 | 2458 | 44 | | ✓ | ✓ | ✓ |
| 400 LED selftest | 1121072 1121074 | | Integral LED | 31.2W | Mains 230V | 3000 | 80 | 2458 | 44 | | ✓ | ✓ | ✓ |

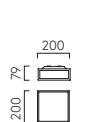

MASHIKO 200

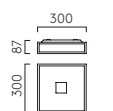

MASHIKO 300/300
LED/300 CLASSIC

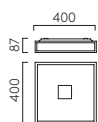

MASHIKO 400

▼ Lamp excluded, see page 714 / La lampe exclu, voir page 714 / La lampadina esclusi a pagina 714 / Das Leuchtmittel ist ausgeschlossen, sie auf Seite 714.

LED





MASHIKO ROUND 230 (1121021)



MASHIKO ROUND 300 LED (1121045)



MASHIKO ROUND

| | | LAMP | WATT | INPUT | K | CRI | Lm | IP | CLASS | ☑ | Ⓢ |
|----------------|--|--------------|---------|------------|------|-----|-----|----|-------|---|---|
| 230 | PCh 1121021 | E27 LED ▼ | 12W max | - | - | - | - | 44 | ☐ | ✓ | ✓ |
| 300 LED | PCh 1121041 Br 1121045 | Integral LED | 16W | Mains 230V | 2700 | 80 | 996 | 44 | ☐ | - | ✓ |
| 300 | PCh 1121017 Br 1121043 | E27 LED ▼ | 12W max | - | - | - | - | 44 | ☐ | ✓ | ✓ |
| 400 | PCh 1121026 | E27 LED ▼ | 12W max | - | - | - | - | 44 | ☐ | ✓ | ✓ |

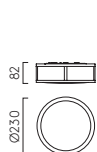

MASHIKO 230

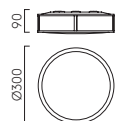

MASHIKO 300/300 LED

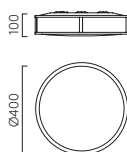

MASHIKO 400

▼ Lamp excluded, see page 714 / La lampe exclu, voir page 714 / La lampadina esclusi a pagina 714 / Das Leuchtmittel ist ausgeschlossen, sie auf Seite 714.

LED





TAKETA 300 LED (1169010)

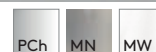

TAKETA

| | | | | LAMP | WATT | INPUT | K | CRI | Lm | IP | CLASS | | |
|------------|----------------|---------|---------|--------------|--------------|------------|------------|------|-----|------|-------|---|-----|
| | | | | Integral LED | 16.3W | Mains 230V | 2700 | 80 | 834 | 44 | | - | ✓ |
| NEW | 400 LED | 1169014 | 1169015 | 1169020 | Integral LED | 27.4W | Mains 230V | 3000 | 83 | 2161 | 44 | | ✓ ✓ |

EMERGENCY

| | | | | | | | | | | | | | |
|------------|-------------------------|---------|---------|---------|--------------|-------|------------|------|----|------|----|--|-----|
| NEW | 400 LED basic | 1169018 | 1169019 | 1169022 | Integral LED | 27.4W | Mains 230V | 3000 | 83 | 2161 | 44 | | ✓ ✓ |
| NEW | 400 LED selftest | 1169016 | 1169017 | 1169021 | Integral LED | 27.4W | Mains 230V | 3000 | 83 | 2161 | 44 | | ✓ ✓ |

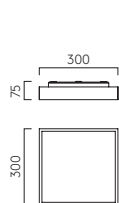

TAKETA 300 LED

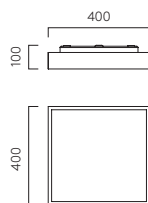

TAKETA 400 LED / 400 LED BASIC / 400 LED SELFTEST

LED





MALLON LED (1125004)



MALLON LED (1125006)



MALLON LED

| | LAMP | WATT | INPUT | K | CRI | Lm | IP | CLASS | | |
|--|--------------|------|------------|------|-----|-----|----|-------|---|---|
| PCh 1125004 MN 1125005 Br 1125006 | Integral LED | 6.2W | Mains 230V | 2700 | 80 | 732 | 44 | | ✓ | ✓ |

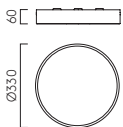

MALLON LED

LED





ALTEA 150 LED (1133004)



ALTEA 300 (1133002)



ALTEA

| | LAMP | WATT | INPUT | K | CRI | Lm | IP | CLASS | | |
|------------------------|--------------|---------|------------|------|-----|-----|----|-------|---|---|
| 150 LED 1133004 | Integral LED | 7.7W | Mains 230V | 2700 | 80 | 346 | 44 | | ✓ | ✓ |
| 300 1133002 | E27 LED▼ | 12W max | - | - | - | - | 44 | | ✓ | ✓ |
| 300 LED 1133007 | Integral LED | 15.6W | Mains 230V | 2700 | 80 | 673 | 44 | | - | ✓ |

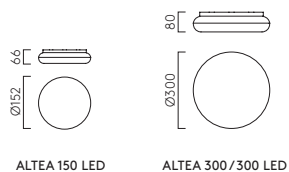

▼ Lamp excluded, see page 714 / La lampe exclu, voir page 714 / La lampadina esclusi a pagina 714 / Das Leuchtmittel ist ausgeschlossen, sie auf Seite 714.

LED





DAKOTA 180 (1129006)



DAKOTA

| | | LAMP | WATT | INPUT | K | CRI | Lm | IP | CLASS | | | |
|----------------|---------|--------------|---------|------------|------|-----|-----|----|-------|---|---|---|
| 180 | 1129006 | E14 LED ▼ | 7W | - | - | - | - | 44 | | ✓ | ✓ | - |
| 300 | 1129001 | E27 LED ▼ | 12W max | - | - | - | - | 44 | | ✓ | ✓ | - |
| 300 LED | 1129007 | Integral LED | 16.1W | Mains 230V | 2700 | 80 | 748 | 44 | | - | ✓ | ✓ |



DAKOTA 180

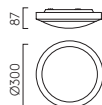

DAKOTA 300/300 LED

▼ Lamp excluded, see page 714 / La lampe exclu, voir page 714 / La lampadina esclusi a pagina 714 / Das Leuchtmittel ist ausgeschlossen, sie auf Seite 714.

LED





OSAKA 350 (1061006)



DENIA (1134001)



OSAKA

| | | LAMP | WATT | INPUT | K | CRI | Lm | IP | CLASS |
|------------|---------|--------------|-------|------------|------|-----|------|----|-------|
| LED | 1061009 | Integral LED | 16W | Mains 230V | 2700 | 80 | 1048 | 44 | |
| 350 | 1061006 | Integral LED | 22.9W | Mains 230V | 3000 | 80 | 1812 | 44 | |

DENIA

| | LAMP | WATT | CLASS | | |
|---------|---------|------------|-------|--|--|
| 1134001 | E14 LED | 2 x 7W max | | | |

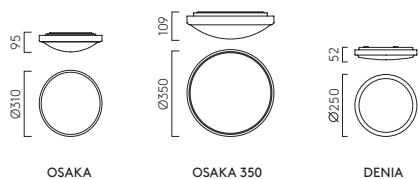

▼ Lamp excluded, see page 714 / La lampe exclu, voir page 714 / La lampadina esclusi a pagina 714 / Das Leuchtmittel ist ausgeschlossen, sie auf Seite 714.

LED





SABINA SQUARE (1292002)



SABINA 280 LED (1291007)

PCh

SABINA

| | | LAMP | WATT | INPUT | K | CRI | Lm | IP | CLASS | ☑ | ☑ |
|----------------|-------------|--------------|---------|------------|------|-----|-----|----|-------|---|---|
| 170 | PCh 1292001 | E27 LED▼ | 12W max | - | - | - | - | 44 | ☐ | ✓ | ✓ |
| 280 | PCh 1292003 | E27 LED▼ | 12W max | - | - | - | - | 44 | ☐ | ✓ | ✓ |
| 280 LED | PCh 1292007 | Integral LED | 15.8W | Mains 230V | 2700 | 80 | 931 | 44 | ☐ | - | ✓ |
| SQUARE | PCh 1292002 | E27 LED▼ | 12W max | - | - | - | - | 44 | ☐ | ✓ | ✓ |

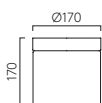

SABINA 170

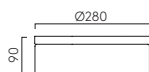

SABINA 280/280 LED

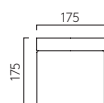

SABINA SQUARE

▼ Lamp excluded, see page 714 / La lampe exclu, voir page 714 / La lampadina esclusi a pagina 714 / Das Leuchtmittel ist ausgeschlossen, sie auf Seite 714.

LED





KIWI CEILING (1390002)



KIWI CEILING

| | LAMP | WATT | INPUT | K | CRI | Lm | IP | CLASS | ⓧ | ⓧ |
|-------------|--------------|------|------------|------|-----|-----|----|-------|---|---|
| PCh 1390002 | Integral LED | 7.3W | Mains 230V | 2700 | 80 | 555 | 44 | □ | ✓ | ✓ |

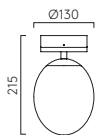

KIWI CEILING





ZEPP0 CEILING (1176001)



ZEPP0 CEILING

PCh 1176001

| LAMP | WATT | CLASS | | |
|-----------|---------|-------|---|---|
| E27 LED ▼ | 12W max | | ✓ | ✓ |

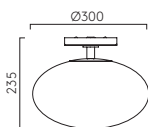

ZEPP0 CEILING

▼ Lamp excluded, see page 714 / La lampe exclu, voir page 714 / La lampadina esclusi a pagina 714 / Das Leuchtmittel ist ausgeschlossen, sie auf Seite 714.





MASSA 300 (1337004)



MASSA

| | | LAMP | WATT | INPUT | K | CRI | Lm | IP | CLASS |  |
|------------|--|--------------|-------|------------|------|-----|------|----|---|---|
| 300 |  1337004 | Integral LED | 16.4W | Mains 230V | 2700 | 80 | 1311 | 44 |  |  |

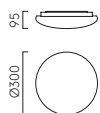

MASSA 300 LED





AREZZO CEILING (1049003)



AREZZO CEILING

PCh 1049003

| LAMP | WATT | CLASS | | |
|----------|---------|-------|---|---|
| E27 LED▼ | 12W max | | ✓ | ✓ |

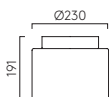

AREZZO CEILING

▼ Lamp excluded, see page 714 / La lampe exclu, voir page 714 / La lampadina esclusi a pagina 714 / Das Leuchtmittel ist ausgeschlossen, sie auf Seite 714.





SYROS (1328001)

WG

SYROS

WG 1328001

| LAMP | WATT | CLASS | | |
|---------|---------|-------|---|---|
| E27 LED | 12W max | | ✓ | ✓ |

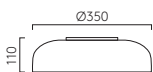

SYROS

▼ Lamp excluded, see page 714 / La lampe exclu, voir page 714 / La lampadina esclusi a pagina 714 / Das Leuchtmittel ist ausgeschlossen, sie auf Seite 714.



PENDANTS

LAMPES SUSPENDUES · ANHÄNGER · LAMPADE A SOSPENSIONE



NEW
 PENDANT
 SUSPENSION KIT 3
 P. 489



MARTINA THREE
 P. 491



MARTINA FIVE
 P. 491



RAFINA
 P. 493



GINESTRA 300
 P. 495



GINESTRA 400/500
 P. 495



ATELIER PENDANT
 P. 497



JOEL PENDANT
 P. 499



NEW
 HOMEFIELD
 PENDANT
 P. 501



ZEPPO
 PENDANT 300/400
 P. 503



NIMIS 350
 P. 505



OSCA PENDANT
 P. 507



1



2



3



FABRIC PENDANTS

PENDANTS TISSU · HÄNGELEUCHTEN AUS STOFF · PENDENTI IN TESSUTO

1. TAPERED ROUND 400 PLEATED (5002009 + 1328001)
2. DRUM 500 (5016011 + 1328001)
3. DRUM 400 PLEATED (5016014 + 1328001)
4. DRUM 420 (5016006 + 1184005)
5. TAPERED ROUND 400 PLEATED (5002008 + 1184005)



PENDANT SHADES

NUANCES PENDENTIF · ANHÄNGER SCHATTIERUNGEN · PARALUMI PENDENT



Ø 420

DRUM 420

- WF 5016004
- BF 5016005
- OF 5016006
- PF 5016028
- MF 5016077



Ø 500

DRUM 500

- WF 5016010
- BF 5016011
- OF 5016012
- PF —
- MF —



Ø 400

DRUM 400 PLEATED

- WF 5016013
- BF 5016014
- OF —
- PF 5016015
- MF —



Ø 500

DRUM 500 PLEATED

- WF 5016016
- BF 5016017
- OF —
- PF 5016018
- MF —



Ø 320

TAPERED 320

- WF 5013020
- BF 5013021
- OF —
- PF 5013022
- MF 5013023



Ø 400

TAPERED ROUND 400 PLEATED

- WF 5002009
- BF —
- OF —
- PF 5002010
- MF —

P. 716: Special Shade Colours / Couleurs spéciales / Sonderfarben / Colori speciali

COLOUR OPTIONS

OPTIONS DE COULEURS · FARBOPTIONEN · OPZIONI DI COLORE

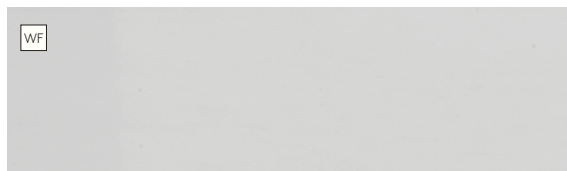

WF*
White fabric
Tissu blanc
Weißer Stoff
Tessuto bianco

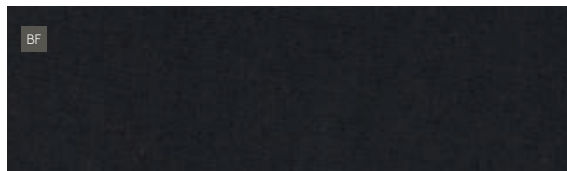

BF*
Black fabric
Tissu noir
Schwarzer Stoff
Tessuto nero



OF*
Oyster fabric
Tissu oyster
Oyster Stoff
Tessuto madreperla (seta)

*SILK/DE LA SOIE/SEIDE/SETA

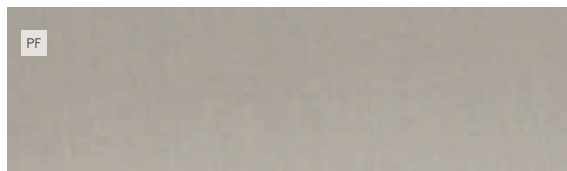

PF*
Putty fabric
Tissu putty
Putty Stoff
Tessuto grigio stucco

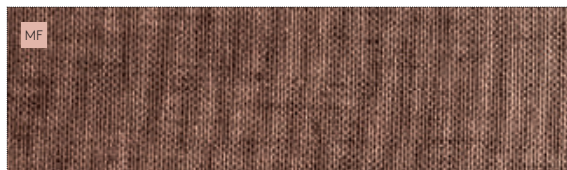

MF*
Mocha fabric
Tissu moka
Mokka Stoff
Tessuto moca

*Please note colours may vary from batch to batch / Merci de noter que les couleurs peuvent varier d'un lot à l'autre / Bitte beachten: Farben können je nach Charge variieren / I colori potrebbero essere diversi a seconda del lotto di produzione.





KIT 1 (1184004) + (5016004) + LOOPING BLOCK



KIT 2 (1184006) + (5016018)



1184010
Pendant Suspension
Kit Knurled



PENDANT SUSPENSION KITS

SHADE EXCLUDED

| | | | | LAMP | WATT | CLASS | |
|--------------------|---------|---------|--|-----------|---------|-------|---|
| KIT 1 | 1184004 | 1184003 | | E27 LED ▼ | 12W max | | ✓ |
| KIT 2 | 1184005 | 1184006 | | E27 LED ▼ | 12W max | | ✓ |
| NEW KIT 3 | 1184009 | 1184011 | | E27 LED ▼ | 12W max | | ✓ |
| NEW KNURLED | 1184010 | | | E27 LED ▼ | 12W max | | ✓ |

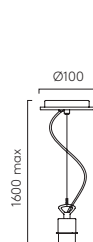

PENDANT SUSPENSION KIT 1

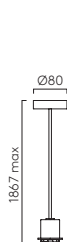

PENDANT SUSPENSION KIT 2

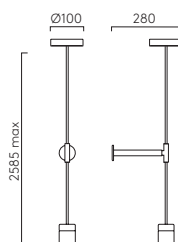

PENDANT SUSPENSION KIT 3/KNURLED



PC: 6015001 MN: 6015002

Looping Block For use with/ convient pour /zur
verwendung mit/da utilizzare con: Pendant
Suspension Kit 1, Zeppo Pendant 300 & Nimis.

▼ Lamp excluded, see page 714 / La lampe exclu, voir
page 714 / La lampadina esclusi a pagina 714 / Das
Leuchtmittel ist ausgeschlossen, sie auf Seite 714.





MARTINA THREE (1302001 + 5006002)

MN

MARTINA

☐ SHADE EXCLUDED

| | | LAMP | WATT | CLASS | ☑ |
|--------------|-------------------|----------|------------|-------|---|
| THREE | MN 1302001 | E14 LED▼ | 3 x 7W max | ⊕ | ✓ |
| FIVE | MN 1302002 | E14 LED▼ | 5 x 7W max | ⊕ | ✓ |

| | | | |
|--|---|---|---|
| 145 Ø 215 TAPERED ROUND 215 WF 5006001 BF 5006002 OF 5006003 PF 5006004 MF 5035011 | 135 Ø 177 TAPERED DRUM 177 WF 5013001 BF 5013002 OF 5013003 PF 5013006 MF — | 180 D. 175 W. 175 TAPERED SQUARE 175 WF 5005001 BF 5005002 OF 5005003 PF 5005004 MF — | 160 Ø 250 DRUM 250 Martina 3 only WF 5016007 BF 5016008 OF 5016009 PF 5016019 MF 5016078 |
|--|---|---|---|

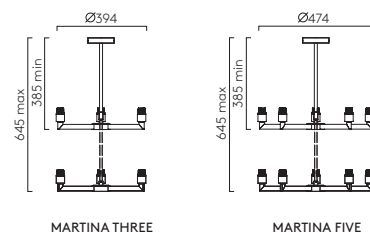

▼ Lamp excluded, see page 714 / La lampe exclu, voir page 714 / La lampadina esclusi a pagina 714 / Das Leuchtmittel ist ausgeschlossen, sie auf Seite 714.





RAFINA (1320001 + 5025001)



RAFINA

SHADE EXCLUDED

MN 1320001 Br 1320004

| LAMP | WATT | CLASS | |
|---------|-------------|-------|---|
| E27 LED | 3 x 12W max | | ✓ |

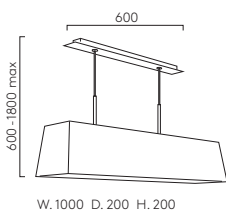

RAFINA SHADE

- WF 5025001
- BF 5025002
- OF 5025003
- PF -

P. 716: Special Colours / Couleurs spéciales / Sonderfarben / Colori speciali

▼ Lamp excluded, see page 714 / La lampe exclu, voir page 714 / La lampadina esclusi a pagina 714 / Das Leuchtmittel ist ausgeschlossen, sie auf Seite 714.





GINESTRA 300 (1361011)



GINESTRA 400 (1361004)

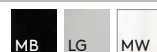

GINESTRA

| | | | | LAMP | WATT | CLASS | |
|------------|---------|---------|---------|-----------|---------|-------|---|
| 300 | 1361001 | 1361003 | 1361011 | E27 LED ▼ | 12W max | | ✓ |
| 400 | 1361002 | 1361004 | 1361012 | E27 LED ▼ | 12W max | | ✓ |
| 500 | 1361014 | 1361015 | 1361013 | E27 LED ▼ | 12W max | | ✓ |

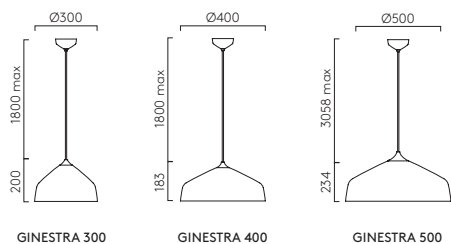

▼ Lamp excluded, see page 714 / La lampe exclu, voir page 714 / La lampadina esclusi a pagina 714 / Das Leuchtmittel ist ausgeschlossen, sie auf Seite 714.





ATELIER PENDANT 150 (1224017)



ATELIER PENDANT 200 (1224022)



ATELIER PENDANT

| | PA | MW | MB | LAMP | WATT | CLASS | |
|-----|---------|---------|---------|-----------|---------|-------|---|
| 150 | 1224017 | 1224018 | 1224019 | E27 LED ▼ | 12W max | | ✓ |
| 200 | 1224020 | 1224021 | 1224022 | E27 LED ▼ | 12W max | | ✓ |

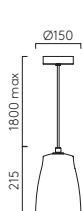

ATELIER PENDANT 150

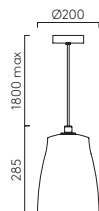

ATELIER PENDANT 200

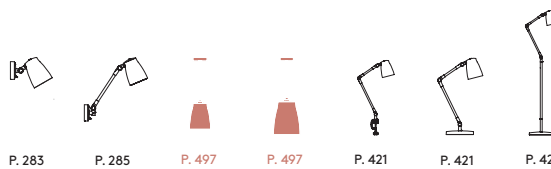

▼ Lamp excluded, see page 714 / La lampe exclu, voir page 714 / La lampadina esclusi a pagina 714 / Das Leuchtmittel ist ausgeschlossen, sie auf Seite 714.





JOEL PENDANT 170 (1223018)



JOEL PENDANT 270 (1223025)



JOEL PENDANT

| | | | | LAMP | WATT | CLASS | |
|-----|---------|---------|--|-----------|---------|-------|---|
| 170 | 1223018 | 1223017 | | E27 LED ▼ | 12W max | | ✓ |
| 270 | 1223023 | 1223025 | | E27 LED ▼ | 12W max | | ✓ |

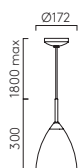

JOEL PENDANT 170

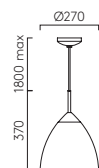

JOEL PENDANT 270

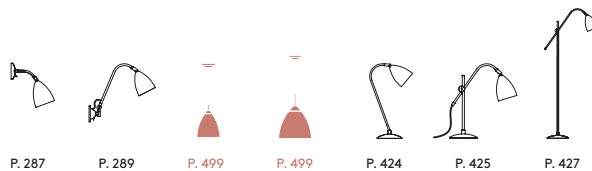

▼ Lamp excluded, see page 714 / La lampe exclu, voir page 714 / La lampadina esclusi a pagina 714 / Das Leuchtmittel ist ausgeschlossen, sie auf Seite 714.





HOMEFIELD PENDANT 240 (1095035)



HOMEFIELD PENDANT 360 (1095020)



HOMEFIELD PENDANT

| | | | | |
|------------|------------|-------------------|-------------------|-------------------|
| NEW | 240 | TB 1095010 | PN 1095019 | NB 1095035 |
| | 360 | TB 1095015 | PN 1095020 | |

| LAMP | WATT | CLASS | | |
|-----------|---------|-------|---|---|
| E27 LED ▼ | 12W max | | ✓ | ✓ |
| E27 LED ▼ | 12W max | | ✓ | ✓ |

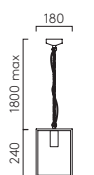

HOMEFIELD
PENDANT 240

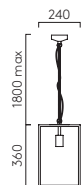

HOMEFIELD
PENDANT 360

▼ Lamp excluded, see page 714 / La lampe exclu, voir page 714 / La lampadina esclusi a pagina 714 / Das Leuchtmittel ist ausgeschlossen, sie auf Seite 714.





ZEPP0 PENDANT 300 (1176002)

PCh MW

ZEPP0 PENDANT

| | | LAMP | WATT | CLASS | | |
|-----|---------|----------|---------|-------|---|---|
| 300 | 1176002 | E27 LED▼ | 12W max | | ✓ | ✓ |
| 400 | 1176003 | E27 LED▼ | 12W max | | ✓ | ✓ |

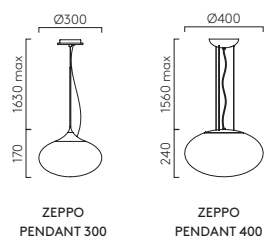

▼ Lamp excluded, see page 714 / La lampe exclu, voir page 714 / La lampadina esclusi a pagina 714 / Das Leuchtmittel ist ausgeschlossen, sie auf Seite 714.





NIMIS 350 (1346001)

WG

NIMIS 350

WG 1346001

| LAMP | WATT | CLASS | | |
|-----------|---------|-------|---|---|
| E27 LED ▼ | 12W max | | ✓ | ✓ |

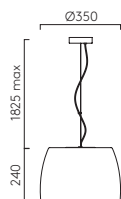

▼ Lamp excluded, see page 714 / La lampe exclu, voir page 714 / La lampadina esclusi a pagina 714 / Das Leuchtmittel ist ausgeschlossen, sie auf Seite 714.





OSCA PENDANT ROUND 400 (1252014)



OSCA PENDANT

| | LAMP | WATT | CLASS | |
|--|-----------|--------|-------|---|
| ROUND 400 P 1252014 | GU10 LED▼ | 6W max | | ✓ |

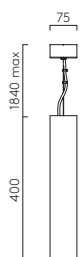

OSCA PENDANT
ROUND

▼ Lamp excluded, see page 714 / La lampe exclu, voir page 714 / La lampadina esclusi a pagina 714 / Das Leuchtmittel ist ausgeschlossen, sie auf Seite 714.



DOWNLIGHTS

DOWNLIGHTS · EINBAUSTRAHLER · FARETTI DE INCASSO



NEW
PROFORM
P. 511



●
VOID
P. 513



●
TRIMLESS ROUND
P. 515



●
TRIMLESS SQUARE
P. 517



TRIMLESS TWIN
P. 517



BLANCO FIXED
P. 519



BLANCO FIXED TWIN
P. 519



BLANCO 45°
P. 519



BLANCO ADJ
P. 521



BLANCO ADJ TWIN
P. 521



●
MINIMA ROUND
P. 523



MINIMA TWIN
P. 523



●
MINIMA SQUARE
P. 525



●
APRILIA ROUND
P. 527



●
APRILIA SQUARE
P. 527



●
APRILIA TWIN
P. 527



TARO ROUND
P. 529



TARO SQUARE
P. 531



TARO TWIN
P. 531



TARO TRIPLE
P. 531



● **NEW**
YUMA SURFACE 250
P. 533



● **NEW**
KINZO 140
P. 535



KOS ROUND
P. 537



KOS SQUARE
P. 537



NEW
SHADOW SURFACE
P. 539



●
OSCA LED ROUND
P. 541



●
OSCA LED SQUARE
P. 541



OSCA FIXED
P. 543



OSCA ADJ
P. 545



OSCA ADJ TWIN
P. 545

LED

PROFORM FT ROUND FIXED



PROFORM FT ROUND ADJUSTABLE + BLACK BEZEL



PROFORM FT SQUARE FIXED + CHROME BEZEL



PROFORM NT ROUND FIXED



PROFORM NT ROUND ADJUSTABLE



PROFORM TL ROUND + BLACK BEZEL



PROFORM TL SQUARE + GOLD BEZEL



NEW PROFORM



DOWNLIGHT

| FT (FULL TRIM) | | LAMP | WATT | INPUT | K | CRI | Lm | IP | CLASS | | | |
|------------------|---------|--------------|-------|--------|------|-----|------|----|-------|--------------|---|---|
| ROUND FIXED | 1423003 | Integral LED | 11.9W | 350mA▼ | 3000 | 90 | 1188 | 20 | | Ø70 | ✓ | ✓ |
| ROUND ADJUSTABLE | 1423005 | Integral LED | 11.9W | 350mA▼ | 3000 | 90 | 1188 | 20 | | Ø83 | ✓ | ✓ |
| SQUARE FIXED | 1423004 | Integral LED | 11.9W | 350mA▼ | 3000 | 90 | 1188 | 20 | | W:70 H:70 | ✓ | ✓ |

| NT (NARROW TRIM) | | LAMP | WATT | INPUT | K | CRI | Lm | IP | CLASS | | | |
|------------------|---------|--------------|-------|--------|------|-----|------|----|-------|-----|---|---|
| ROUND FIXED | 1423001 | Integral LED | 11.9W | 350mA▼ | 3000 | 90 | 1188 | 20 | | Ø76 | ✓ | ✓ |
| ROUND ADJUSTABLE | 1423002 | Integral LED | 11.9W | 350mA▼ | 3000 | 90 | 1188 | 20 | | Ø76 | ✓ | ✓ |

| TL (TRIMLESS) | | LAMP | WATT | INPUT | K | CRI | Lm | IP | CLASS | | | |
|---------------|---------|--------------|-------|--------|------|-----|------|----|-------|--------------|---|---|
| ROUND FIXED | 1423006 | Integral LED | 11.9W | 350mA▼ | 3000 | 90 | 1188 | 20 | | Ø62 | ✓ | ✓ |
| SQUARE FIXED | 1423007 | Integral LED | 11.9W | 350mA▼ | 3000 | 90 | 1188 | 20 | | W:67 H:67 | ✓ | ✓ |

ACCESSORIES



ROUND BEZELS

- 6024005
- 6024006
- 6024007



SQUARE BEZELS

- 6024008
- 6024009
- 6024010

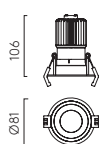

PROFORM ROUND FT FIXED

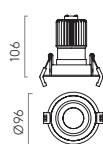

PROFORM ROUND FT ADJUSTABLE

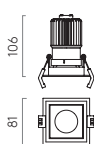

PROFORM SQUARE FT FIXED

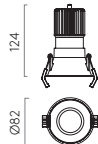

PROFORM ROUND NT FIXED

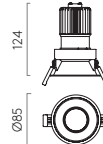

PROFORM ROUND NT ADJUSTABLE

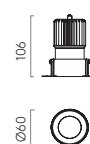

PROFORM ROUND TL FIXED

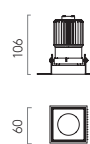

PROFORM SQUARE TL FIXED

▼ Driver excluded, see page 714. Driver exclu, voir page 714. Driver esclusi a pagina 714. / Das Leuchtmittel/ treiber ist ausgeschlossen, sie auf Seite 714.

LED

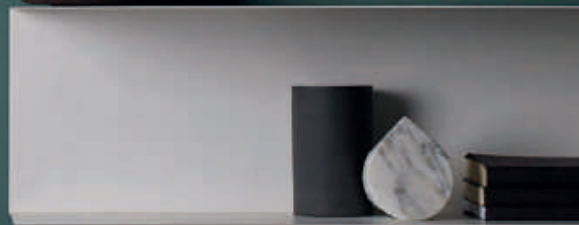

THE VOID RANGE MUST
BE INSTALLED BEFORE
PLASTERING

La gamme Void doit être impérativement installée avant plafonnage./Die Void Produktreihe muss vor dem Verputzen eingebaut werden./La linea Void deve essere installata prima della posa del controsoffitto.

▶ TO VIEW A 'HOW TO INSTALL' VIDEO,
PLEASE VISIT: [ASTROLIGHTING.COM](https://www.astrolighting.com)

La gamme Void doit être impérativement installée avant plafonnage. Pour visionner une "vidéo d'installation" veuillez visiter. /Die Void Produktreihe muss vor dem Verputzen eingebaut werden. Um ein Montagevideo anzusehen, besuchen Sie bitte. /La linea Void deve essere installata prima della posa del controsoffitto. Per visualizzare un video su 'come installare' visitate il nostro sito.

VOID



55

| | LAMP | WATT | INPUT | K | CRI | Lm | IP | CLASS | | | | |
|------------------|--------------|--------|--------|------|-----|-----|----|-------|-----|---|-----|-----|
| 1392004 | Integral LED | 6.8W | 700mA▼ | 2700 | 80 | 501 | 65 | | Ø70 | ✓ | 25° | ✓ ✓ |
| 1392001 | Integral LED | 6.8W | 700mA▼ | 3000 | 80 | 525 | 65 | | Ø70 | ✓ | 26° | ✓ ✓ |
| 1392017 1392018 | GU10 LED▼ | 6W max | - | - | - | - | 65 | | Ø73 | ✓ | - | ✓ - |

80

| | | | | | | | | | | | | |
|------------------|--------------|--------|--------|------|----|-----|----|--|-----|---|-----|-----|
| 1392002 | Integral LED | 9.1W | 250mA▼ | 3000 | 80 | 877 | 65 | | Ø95 | ✓ | 26° | ✓ ✓ |
| 1392005 | Integral LED | 9.1W | 250mA▼ | 2700 | 80 | 863 | 65 | | Ø95 | ✓ | 14° | ✓ ✓ |
| 1392006 | Integral LED | 9.1W | 250mA▼ | 2700 | 93 | 690 | 65 | | Ø95 | ✓ | 14° | ✓ ✓ |
| 1392007 | Integral LED | 9.1W | 250mA▼ | 3000 | 80 | 888 | 65 | | Ø95 | ✓ | 14° | ✓ ✓ |
| 1392008 | Integral LED | 9.1W | 250mA▼ | 3000 | 93 | 668 | 65 | | Ø95 | ✓ | 14° | ✓ ✓ |
| 1392009 | Integral LED | 9.1W | 250mA▼ | 2700 | 93 | 611 | 65 | | Ø95 | ✓ | 25° | ✓ ✓ |
| 1392010 | Integral LED | 9.1W | 250mA▼ | 3000 | 93 | 653 | 65 | | Ø95 | ✓ | 25° | ✓ ✓ |
| 1392012 | Integral LED | 9.1W | 250mA▼ | 2700 | 80 | 840 | 65 | | Ø95 | ✓ | 25° | ✓ ✓ |
| 1392019 1392016 | GU10 LED▼ | 6W max | - | - | - | - | 65 | | Ø98 | ✓ | - | ✓ - |

100

| | | | | | | | | | | | | |
|---------|--------------|-------|--------|------|----|------|----|--|------|---|-----|-----|
| 1392003 | Integral LED | 12.7W | 350mA▼ | 3000 | 80 | 1230 | 65 | | Ø117 | ✓ | 26° | ✓ ✓ |
| 1392011 | Integral LED | 12.7W | 350mA▼ | 2700 | 80 | 1219 | 65 | | Ø117 | ✓ | 26° | ✓ ✓ |

ACCESSORIES



55 BLACK BEZEL
1392013



80 BLACK BEZEL
1392014



100 BLACK BEZEL
1392015

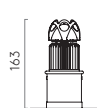

VOID 55 LED

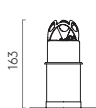

VOID 55 GU10

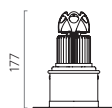

VOID 80 LED

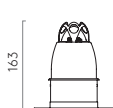

VOID 80 GU10

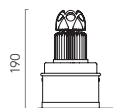

VOID 100 LED

⚡ Our fire rated downlights comply with all the latest building regulations: Part B - Fire Safety. The downlights have been tested to provide a minimum of 90 minutes fire protection (BS 476: part 21).

▼ Lamp or driver excluded, see page 714. La lampe / driver exclu, voir page 714. La lampadina / driver esclusi a pagina 714. Das Leuchtmittel / treiber ist ausgeschlossen, sie auf Seite 714.

LED

THE TRIMLESS RANGE MUST BE
INSTALLED BEFORE PLASTERING

La gamme Trimless doit être
imperativement installée avant plafonnage.
/ Die Trimless Produktreihe muss vor dem
Verputzen eingebaut werden. / La linea
Trimless deve essere installata prima della
posa del controsoffitto.

▶ TO VIEW A 'HOW TO INSTALL' VIDEO,
PLEASE VISIT: ASTROLIGHTING.COM

La gamme Trimless doit être imperativement
installée avant plafonnage. Pour visionner
une "vidéo d'installation" veuillez visiter. / Die
Trimless Produktreihe muss vor dem Verputzen
eingebaut werden. Um ein Montagevideo
anzusehen, besuchen Sie bitte. / La linea
Trimless deve essere installata prima della
posa del controsoffitto. Per visualizzare un
video su 'come installare' visitate il nostro sito.

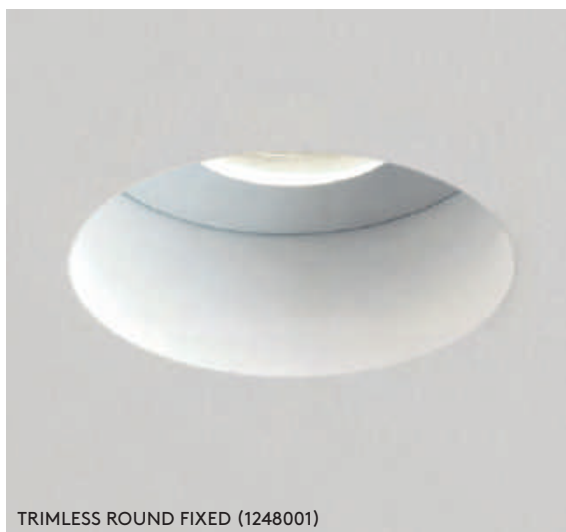

TRIMLESS ROUND FIXED (1248001)

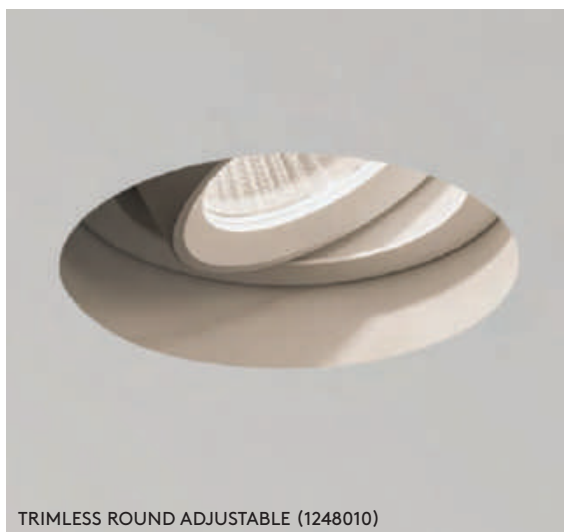

TRIMLESS ROUND ADJUSTABLE (1248010)



TRIMLESS

| | LAMP | WATT | INPUT | K | CRI | Lm | IP | CLASS | | | | | |
|-------------------------|------------------------|--------|--------------------|------|-----|-----|----|-------|------|---|---|---|--|
| ROUND FIXED | | | | | | | | | | | | | |
| 1248011 | Integral LED | 6.8W | 700mA [▼] | 2700 | 80 | 455 | 20 | | Ø83 | ✓ | ✓ | ✓ | |
| 1248001 | GU5.3 LED [▼] | 6W max | 12V [▼] | - | - | - | 65 | | Ø86 | ✓ | ✓ | ✓ | |
| 1248002 | GU10 LED [▼] | 6W max | - | - | - | - | 65 | | Ø86 | ✓ | ✓ | ✓ | |
| ROUND ADJUSTABLE | | | | | | | | | | | | | |
| 1248010 | Integral LED | 6.8W | 700mA [▼] | 2700 | 80 | 528 | 20 | | Ø79 | ✓ | - | ✓ | |
| 1248006 | GU10 LED [▼] | 6W max | - | - | - | - | 20 | | Ø111 | ✓ | ✓ | - | |

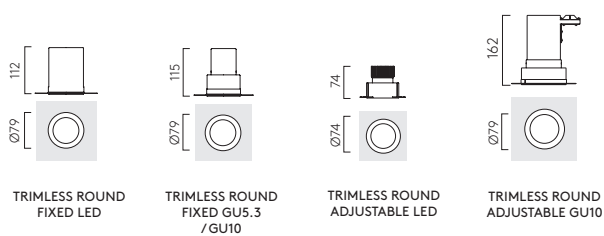

♣ Our fire rated downlights comply with all the latest building regulations: Part B - Fire Safety. The downlights have been tested to provide a minimum of 90 minutes fire protection (BS 476: part 21).

▼ Lamp or driver excluded, see page 714. La lampe / driver exclu, voir page 714. La lampadina / driver esclusi a pagina 714. Das Leuchtmittel / treiber ist ausgeschlossen, sie auf Seite 714.





TRIMLESS TWIN ADJUSTABLE (1248008)



TRIMLESS SQUARE ADJUSTABLE (1248009)

MW

TRIMLESS

| | LAMP | WATT | INPUT | K | CRI | Lm | IP | CLASS | | | | |
|--------------------------|--------------|------------|--------|------|-----|-----|----|-------|----------------|---|---|---|
| SQUARE FIXED | | | | | | | | | | | | |
| 1248005 | GU10 LED▼ | 6W max | - | - | - | - | 65 | | W:95 H:95 | ✓ | ✓ | - |
| 1248012 | Integral LED | 6.8W | 700mA▼ | 2700 | 80 | 475 | 20 | | W:83 H:83 | ✓ | ✓ | ✓ |
| SQUARE ADJUSTABLE | | | | | | | | | | | | |
| 1248007 | GU10 LED▼ | 6W max | - | - | - | - | 20 | | W:111 H:111 | ✓ | ✓ | - |
| 1248009 | Integral LED | 6.8W | 700mA▼ | 2700 | 80 | 544 | 20 | | W:100 H:95 | ✓ | - | ✓ |
| TWIN ADJUSTABLE | | | | | | | | | | | | |
| 1248008 | GU10 LED▼ | 2 x 6W max | - | - | - | - | 20 | | W:111 H:215 | ✓ | ✓ | - |

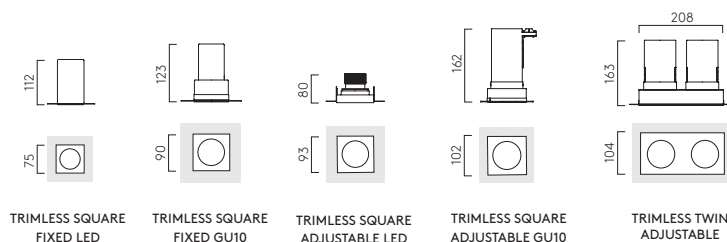

THE TRIMLESS RANGE MUST BE INSTALLED BEFORE PLASTERING

La gamme Trimless doit être impérativement installée avant plafonnage. / Die Trimless Produktreihe muss vor dem Verputzen eingebaut werden. / La linea Trimless deve essere installata prima della posa del controsoffitto.

▶ TO VIEW A 'HOW TO INSTALL' VIDEO, PLEASE VISIT: ASTROLIGHTING.COM

La gamme Trimless doit être impérativement installée avant plafonnage. Pour visionner une "vidéo d'installation" veuillez visiter. / Die Trimless Produktreihe muss vor dem Verputzen eingebaut werden. Um ein Montagevideo anzusehen, besuchen Sie bitte. / La linea Trimless deve essere installata prima della posa del controsoffitto. Per visualizzare un video su 'come installare' visitate il nostro sito.

⚡ Our fire rated downlights comply with all the latest building regulations: Part B - Fire Safety. The downlights have been tested to provide a minimum of 90 minutes fire protection (BS 476: part 21).

▼ Lamp / or driver excluded, see page 714. La lampada / driver exclu, voir page 714. La lampadina / driver esclusi a pagina 714. Das Leuchtmittel / treiber ist ausgeschlossen, sie auf Seite 714.





BLANCO ROUND FIXED (1253004)



BLANCO 45° (1253003)



BLANCO TWIN FIXED (1253001)



BLANCO

| | | LAMP | WATT | CLASS | | |
|--------------|---------|-----------|------------|-------|----------------|---|
| ROUND FIXED | 1253004 | GU10 LED▼ | 6W max | | Ø131 | ✓ |
| SQUARE FIXED | 1253002 | GU10 LED▼ | 6W max | | W:120 H:120 | ✓ |
| TWIN FIXED | 1253001 | GU10 LED▼ | 2 x 6W max | | W:190 H:120 | ✓ |
| 45° | 1253003 | GU10 LED▼ | 6W max | | W:126 H:125 | ✓ |

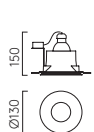

BLANCO ROUND

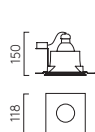

BLANCO SQUARE

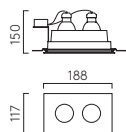

BLANCO TWIN

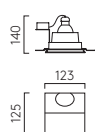

BLANCO 45°

The Blanco range is ideally installed after plastering, requiring only minimal filling after installation. La gamme Blanco est idéalement installée après le plafonnage et requiert un minimum de finition. / Die Blanco Produktpalette sollte idealerweise nach dem Verputzen eingebaut werden, da sie nach der Installation nur eine minimale Auffüllung erfordern. / La linea Blanco può essere installata dopo la posa del controsoffitto, richiede solo una stuccatura finale.

▼ Lamp excluded, see page 714 / La lampe exclu, voir page 714 / La lampadina esclusi a pagina 714 / Das Leuchtmittel ist ausgeschlossen, sie auf Seite 714.



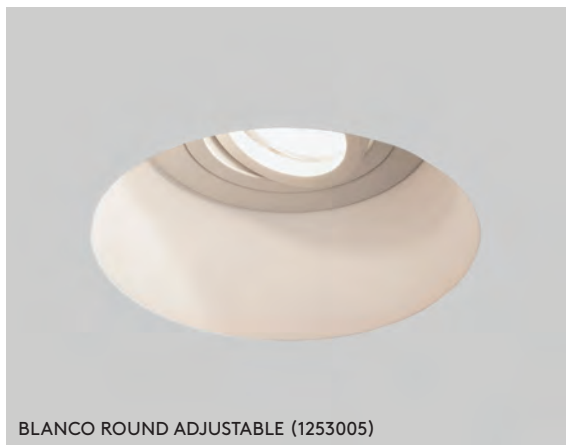

BLANCO ROUND ADJUSTABLE (1253005)



BLANCO SQUARE ADJUSTABLE (1253007)

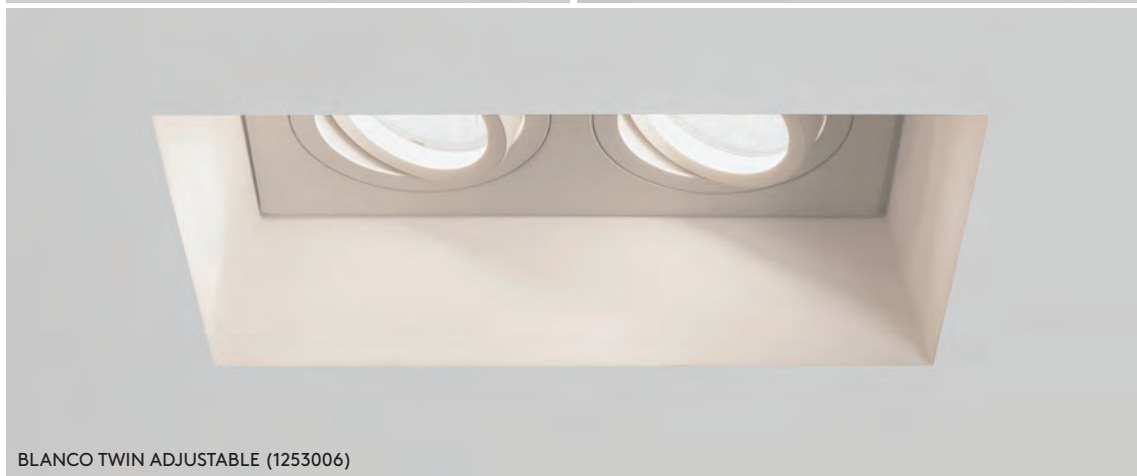

BLANCO TWIN ADJUSTABLE (1253006)



BLANCO

| | | LAMP | WATT | CLASS | | |
|--------------------------|---------|------------|------------|-------|----------------|---|
| ROUND ADJUSTABLE | 1253005 | GU10 LED ▼ | 6W max | | Ø152 | ✓ |
| SQUARE ADJUSTABLE | 1253007 | GU10 LED ▼ | 6W max | | W:150 H:150 | ✓ |
| TWIN ADJUSTABLE | 1253006 | GU10 LED ▼ | 2 x 6W max | | W:230 H:150 | ✓ |

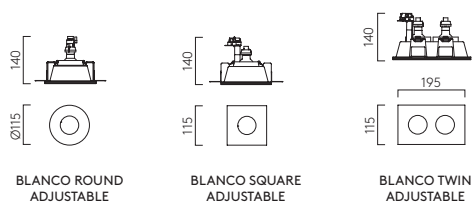

The Blanco range is ideally installed after plastering, requiring only minimal filling after installation. La gamme Blanco est idéalement installée après le plafonnage et requiert un minimum de finition. Die Blanco Produktpalette sollte idealerweise nach dem Verputzen eingebaut werden, da sie nach der Installation nur eine minimale Auffüllung erfordern. / La linea Blanco può essere installata dopo la posa del controsoffitto, richiede solo una stuccatura finale.

▼ Lamp excluded, see page 714 / La lampe exclu, voir page 714 / La lampadina esclusi a pagina 714 / Das Leuchtmittel ist ausgeschlossen, sie auf Seite 714.

LED



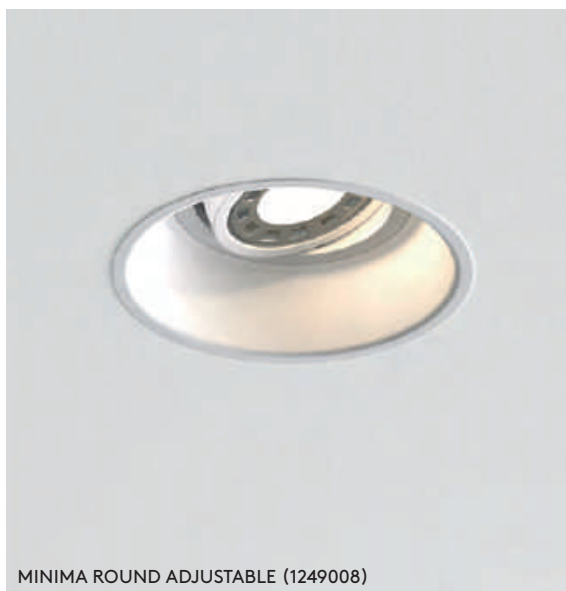

MINIMA ROUND

| | LAMP | WATT | INPUT | K | CRI | Lm | CLASS | ⚡ | 🕒 | 🔥 | 🌐 |
|-------------------------------------|-----------------------|------------|--------------------|------|-----|-----|-------|-------------|---|---|---|
| FIXED | | | | | | | | | | | |
| TW 1249005 | Integral LED | 6.8W | 700mA [▼] | 2700 | 80 | 434 | ⬡ | Ø76 | ✓ | - | ✓ |
| MW 1249002 MB 1249015 | GU10 LED [▼] | 6W max | - | - | - | - | ⊕ | Ø76 | ✓ | - | - |
| MW 1249010 | GU10 LED [▼] | 6W max | - | - | - | - | ⊕ | Ø92 | ✓ | ✓ | - |
| ADJUSTABLE | | | | | | | | | | | |
| MW 1249003 MB 1249016 | GU10 LED [▼] | 6W max | - | - | - | - | ⊕ | Ø76 | ✓ | - | - |
| MW 1249008 | GU10 LED [▼] | 6W max | - | - | - | - | ⊕ | Ø92 | ✓ | ✓ | - |
| TWIN ADJUSTABLE | | | | | | | | | | | |
| MW 1249028 MB 1249029 | GU10 LED [▼] | 2 x 6W max | - | - | - | - | ⊕ | W:92 Ø95 | ✓ | ✓ | - |
| 25° | | | | | | | | | | | |
| MW 1249025 MB 1249026 | GU10 LED [▼] | 6W max | - | - | - | - | ⊕ | Ø111 | ✓ | - | - |

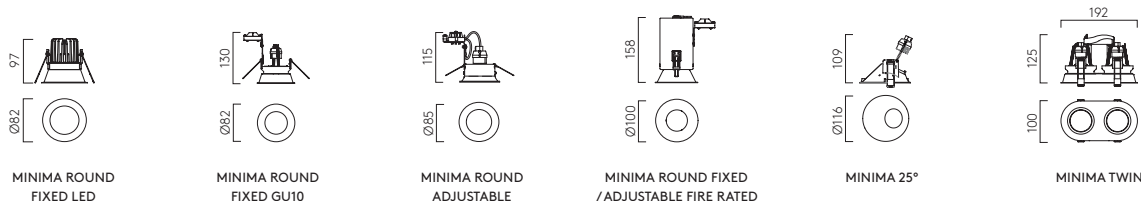

⬆ Our fire rated downlights comply with all the latest building regulations: Part B - Fire Safety. The downlights have been tested to provide a minimum of 90 minutes fire protection (BS 476: part 21).

▼ Lamp / or driver excluded, see page 714 / La lampe / driver exclu, voir page 714 / La lampadina / driver esclusi a pagina 714 / Das Leuchtmittel / treiber ist ausgeschlossen, sie auf Seite 714.





MINIMA SQUARE FIXED (1249007)



MINIMA SQUARE ADJUSTABLE (1249020)



MINIMA SQUARE

FIXED

- MW 1249007 MB 1249019
- MW 1249011

ADJUSTABLE

- MW 1249006 MB 1249020
- MW 1249009

| LAMP | WATT | CLASS | | |
|-----------|--------|-------|-----------|-----|
| GU10 LED▼ | 6W max | | W:92 L:92 | ✓ - |
| GU10 LED▼ | 6W max | | W:92 L:92 | ✓ ✓ |
| GU10 LED▼ | 6W max | | W:92 L:92 | ✓ - |
| GU10 LED▼ | 6W max | | W:92 L:92 | ✓ ✓ |

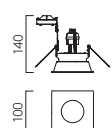

MINIMA SQUARE
FIXED/ADJUSTABLE

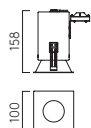

MINIMA SQUARE
FIXED FIRE RATED

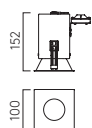

MINIMA SQUARE
ADJUSTABLE FIRE RATED

◆ Our fire rated downlights comply with all the latest building regulations: Part B - Fire Safety. The downlights have been tested to provide a minimum of 90 minutes fire protection (BS 476: part 21).

▼ Lamp excluded, see page 714 / La lampe exclu, voir page 714 / La lampadina esclusi a pagina 714 / Das Leuchtmittel ist ausgeschlossen, sie auf Seite 714.





APRILIA ROUND (1256013)



APRILIA TWIN (1256019)



APRILIA

| ROUND | LAMP | WATT | INPUT | K | CRI | Lm | CLASS | ⚡ | 🕒 | 🔥 | 🌐 |
|------------|--------------|----------|--------|------|-----|------|-------|---------------|---|---|---|
| MW 1256020 | Integral LED | 6.1W | 350mA▼ | 3000 | 80 | 628 | ◆ | Ø86 | ✓ | - | ✓ |
| MW 1256024 | Integral LED | 6.1W | 350mA▼ | 2700 | 80 | 605 | ◆ | Ø86 | ✓ | - | ✓ |
| MW 1256013 | Integral LED | 6.1W | 350mA▼ | 2700 | 80 | 605 | ◆ | Ø92 | ✓ | ✓ | ✓ |
| SQUARE | | | | | | | | | | | |
| MW 1256021 | Integral LED | 6.1W | 350mA▼ | 3000 | 80 | 628 | ◆ | Ø86 | ✓ | - | ✓ |
| MW 1256026 | Integral LED | 6.1W | 350mA▼ | 2700 | 80 | 605 | ◆ | Ø86 | ✓ | - | ✓ |
| MW 1256014 | Integral LED | 6.1W | 350mA▼ | 2700 | 80 | 605 | ◆ | Ø92 | ✓ | ✓ | ✓ |
| TWIN | | | | | | | | | | | |
| MW 1256019 | Integral LED | 2 x 6.1W | 350mA▼ | 3000 | 80 | 1206 | ◆ | W:165 L:85 | ✓ | - | ✓ |
| MW 1256022 | Integral LED | 2 x 6.1W | 350mA▼ | 2700 | 80 | 1123 | ◆ | W:165 L:85 | ✓ | - | ✓ |

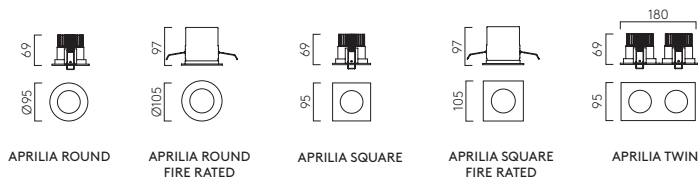

⚡ Our fire rated downlights comply with all the latest building regulations: Part B - Fire Safety. The downlights have been tested to provide a minimum of 90 minutes fire protection (BS 476: part 21).

▼ Driver excluded, see page 714 / Driver d'entrée exclu, voir page 714 / Driver esclusi a pagina 714 / Das treiber ist ausgeschlossen / Sie auf Seite 714.





TARO ROUND ADJUSTABLE (1240015)



TARO ROUND FIXED (1240013)



TARO ROUND

| FIXED | | LAMP | WATT | CLASS | | | |
|------------|---------|------------|--------|-------|-----|---|---|
| 1240013 | 1240011 | GU10 LED ▼ | 6W max | | Ø79 | ✓ | - |
| 1240024 | | GU10 LED ▼ | 6W max | | Ø86 | ✓ | ✓ |
| ADJUSTABLE | | | | | | | |
| 1240028 | 1240027 | GU10 LED ▼ | 6W max | | Ø86 | ✓ | ✓ |
| 1240015 | | GU10 LED ▼ | 6W max | | Ø79 | ✓ | - |

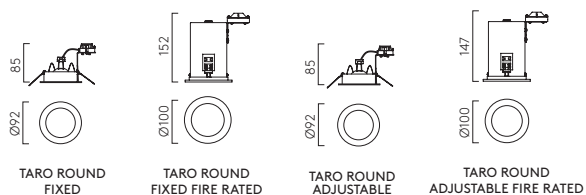

◆ Our fire rated downlights comply with all the latest building regulations: Part B - Fire Safety. The downlights have been tested to provide a minimum of 90 minutes fire protection (BS 476: part 21).

▼ Lamp excluded, see page 714 / La lampe exclu, voir page 714 / La lampadina esclusi a pagina 714 / Das Leuchtmittel ist ausgeschlossen, sie auf Seite 714.





TARO SQUARE

| FIXED | | LAMP | WATT | CLASS | ⌀ | ⌚ | 🔥 |
|-------------------|------------|-----------|------------|-------|------------|---|---|
| MW 1240014 | | GU10 LED▼ | 6W max | ⊕ | Ø79 | ✓ | - |
| MW 1240026 | | GU10 LED▼ | 6W max | ⊕ | Ø86 | ✓ | ✓ |
| ADJUSTABLE | | | | | | | |
| MW 1240016 | BA 1240012 | GU10 LED▼ | 6W max | ⊕ | Ø79 | ✓ | - |
| MW 1240030 | BA 1240029 | GU10 LED▼ | 6W max | ⊕ | Ø86 | ✓ | ✓ |
| TWIN ADJUSTABLE | | | | | | | |
| MW 1240017 | BA 1240018 | GU10 LED▼ | 2 x 6W max | ⊕ | W:160 Ø80 | ✓ | - |
| MW 1240032 | BA 1240031 | GU10 LED▼ | 2 x 6W max | ⊕ | W:184 Ø89 | ✓ | ✓ |
| TRIPLE ADJUSTABLE | | | | | | | |
| MW 1240019 | | GU10 LED▼ | 3 x 6W max | ⊕ | W:80 L:235 | ✓ | - |

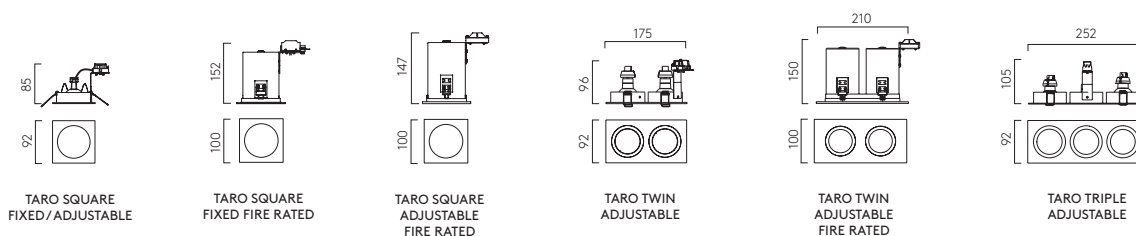

⬆ Our fire rated downlights comply with all the latest building regulations: Part B - Fire Safety. The downlights have been tested to provide a minimum of 90 minutes fire protection (BS 476: part 21).

▼ Lamp excluded, see page 714 / La lampe exclu, voir page 714 / La lampadina esclusi a pagina 714 / Das Leuchtmittel ist ausgeschlossen, sie auf Seite 714.

LED





YUMA SURFACE 250 (1399013)



YUMA SURFACE 250 (1399015)

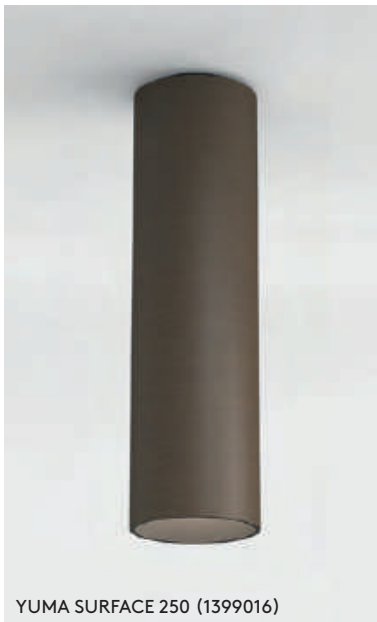

YUMA SURFACE 250 (1399016)



NEW YUMA SURFACE 250

| | LAMP | WATT | INPUT | K | CRI | Lm | CLASS | |
|---|--------------|-------|------------|------|-----|-----|-------|-------|
| TW 1399013 TB 1399014 MN 1399015 Br 1399016 | Integral LED | 10.3W | Mains 230V | 2700 | 80 | 538 | ⊕ | Phase |



YUMA SURFACE 250



YUMA SURFACE 250 BEZEL
6024004

LED



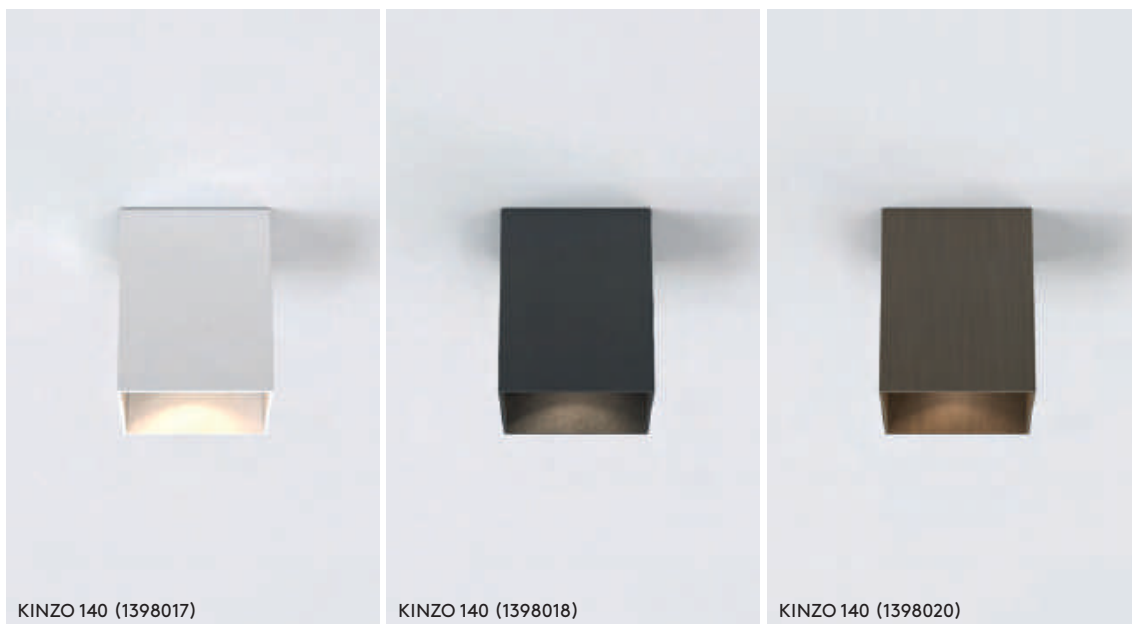

KINZO 140 (1398017)

KINZO 140 (1398018)

KINZO 140 (1398020)



NEW

KINZO 140

| | LAMP | WATT | INPUT | K | CRI | Lm | CLASS | |
|---|--------------|-------|------------|------|-----|-----|-------|---|
| TW 1398017 TB 1398018 MN 1398019 Br 1398020 | Integral LED | 12.5W | Mains 230V | 2700 | 80 | 760 | ⊕ | ✓ |

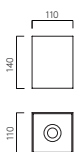

KINZO 140





KOS ROUND (1326041)



KOS SQUARE 140 LED (1326043)



KOS

ROUND

| | LAMP | WATT | IP | CLASS | ⏻ | Ⓢ |
|----------------|--------------|--------|----|-------|-------|---|
| 100 LED | GU10 LED | 6W max | 65 | ⊕ | ✓ | ✓ |
| 140 LED | Integral LED | 5.9W | 65 | ⊕ | phase | ✓ |
| | Integral LED | 11.9W | 65 | ⊕ | phase | ✓ |

SQUARE

| | LAMP | WATT | IP | CLASS | ⏻ | Ⓢ |
|----------------|--------------|--------|----|-------|-------|---|
| 100 LED | GU10 LED | 6W max | 65 | ⊕ | ✓ | ✓ |
| | Integral LED | 5.9W | 65 | ⊕ | phase | ✓ |
| | Integral LED | 11.9W | 65 | ⊕ | phase | ✓ |

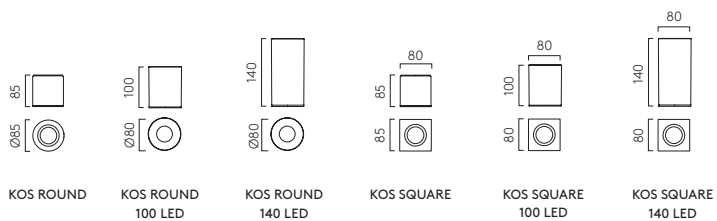

▼ Lamp excluded, see page 714 / La lampe exclu, voir page 714 / La lampadina esclusi a pagina 714 / Das Leuchtmittel ist ausgeschlossen, sie auf Seite 714.





SHADOW SURFACE 150 (1414003)



SHADOW SURFACE 220 (1414004)



NEW SHADOW SURFACE

| | | LAMP | WATT | CLASS | |
|-----|---------|-----------|--------|-------|---|
| 150 | 1414003 | GU10 LED▼ | 6W max | | ✓ |
| 220 | 1414004 | GU10 LED▼ | 6W max | | ✓ |

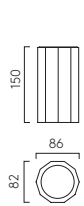

SHADOW SURFACE 150



SHADOW SURFACE 220

▼ Lamp excluded, see page 714 / La lampe exclu, voir page 714 / La lampadina esclusi a pagina 714 / Das Leuchtmittel ist ausgeschlossen, sie auf Seite 714.

LED





OSCA LED ROUND (1252022)



OSCA LED SQUARE (1252024)



OSCA LED

| | LAMP | WATT | INPUT | K | CRI | Lm | CLASS | |
|---------------|------------------|--------------|-------|------------|------|----|-------|-------|
| ROUND | 1252022 1252023 | Integral LED | 7.7W | Mains 230V | 2700 | 80 | 528 | Phase |
| SQUARE | 1252024 1252025 | Integral LED | 7.8W | Mains 230V | 2700 | 80 | 507 | Phase |

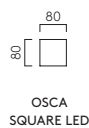
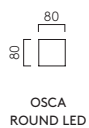



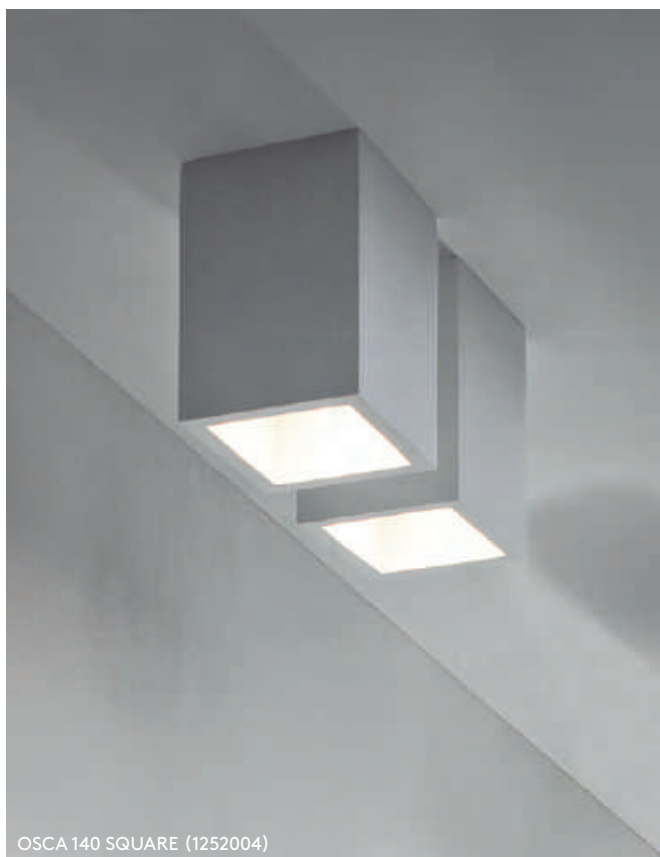

OSCA 140 SQUARE (1252004)



OSCA 200 ROUND (1252011)



OSCA FIXED

| | | LAMP | WATT | CLASS | |
|-------------------|---------|-----------|---------|-------|---|
| 140 ROUND | 1252003 | GU10 LED▼ | 6W max | | ✓ |
| 140 SQUARE | 1252004 | GU10 LED▼ | 6W max | | ✓ |
| 200 ROUND | 1252011 | E27 LED▼ | 12W max | | ✓ |



OSCA 140 ROUND



OSCA 140 SQUARE



OSCA 200 ROUND

▼ Lamp excluded, see page 714 / La lampe exclu, voir page 714 / La lampadina esclusi a pagina 714 / Das Leuchtmittel ist ausgeschlossen, sie auf Seite 714.





OSCA ADJUSTABLE

| | | LAMP | WATT | CLASS | |
|-------------------|---------|-----------|------------|-------|---|
| 140 ROUND | 1252006 | GU10 LED▼ | 6W max | | ✓ |
| 140 SQUARE | 1252007 | GU10 LED▼ | 6W max | | ✓ |
| 140 TWIN | 1252005 | GU10 LED▼ | 2 x 6W max | | ✓ |

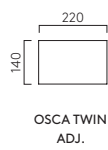
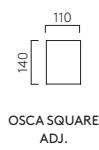

▼ Lamp excluded, see page 714 / La lampe exclu, voir page 714 / La lampadina esclusi a pagina 714 / Das Leuchtmittel ist ausgeschlossen, sie auf Seite 714.



SPOTLIGHTS

SPOT · SPOTLIGHT · RIFLETTORI ORIENTABILI



NEW
LYNX
P. 549



CAN TRACK SPOT
P. 551



ASCOLI TRACK SPOT
P. 551



CAN SINGLE
P. 553



CAN RECESSED
P. 553



CAN TRIPLE ROUND
P. 553



CAN TRIPLE BAR
P. 553



CAN FOUR BAR
P. 553



NEW
ASCOLI SINGLE
P. 555



NEW
ASCOLI RECESSED
P. 555



NEW
ASCOLI SINGLE SWITCHED
P. 555



NEW
ASCOLI TWIN
P. 555



NEW
ASCOLI TRIPLE ROUND
P. 555



NEW
ASCOLI 3/4/5 BAR
P. 555





LYNX (1403001)



LYNX RECESS (1403004)



NEW

LYNX

| | | | LAMP | WATT | INPUT | K | CRI | Lm | CLASS | |
|---------------|-------------------|-------------------|--------------|-------|------------|------|-----|------|-------|---|
| | MW 1403001 | MB 1403002 | Integral LED | 12.5W | Mains 230V | 3000 | 80 | 1000 | ⊕ | ✓ |
| RECESS | MW 1403003 | MB 1403004 | Integral LED | 12.5W | Mains 230V | 3000 | 80 | 1000 | ⊕ | ✓ |



LYNX



LYNX RECESS

LED





CAN 50 SPOT (1396001) + CAN 75 SPOT (1396003) + ASCOLI TRACK SPOT (1286033)



TRACK SPOTLIGHTS

| | | | LAMP | WATT | INPUT | K | CRI | Lm | CLASS | |
|-------------------|---------|---------|-----------------------|--------|------------|------|-----|------|-------|--|
| CAN 50 SPOT | 1396001 | 1396002 | Integral LED | 7.7W | Mains 230V | 3000 | 80 | 502 | | |
| CAN 75 SPOT | 1396003 | 1396004 | Integral LED | 11.8W | Mains 230V | 3000 | 80 | 986 | | |
| CAN 100 SPOT | 1396014 | 1396015 | Integral LED | 30.2W | Mains 230V | 3000 | 80 | 1678 | | |
| ASCOLI TRACK SPOT | 1286033 | 1286052 | GU10 LED [▼] | 6W max | - | - | - | - | | |

TRACK ACCESSORIES

| | | | | |
|---|---------|---------|-----------------------------|---------|
| 1M TRACK | 6020001 | 6020009 | NEW CORNER SUPPORT | 6020036 |
| 2M TRACK | 6020002 | 6020010 | NEW STRAIGHT SUPPORT | 6020035 |
| END CAP | 6020003 | 6020011 | NEW T SUPPORT | 6020037 |
| END TO END CONNECTOR | 6020004 | 6020012 | NEW X SUPPORT | 6020034 |
| LIVE END | 6020005 | 6020013 | | |
| LEFT CORNER CONNECTOR | 6020006 | 6020014 | | |
| RIGHT CORNER CONNECTOR | 6020007 | 6020015 | | |
| X CONNECTOR | 6020019 | 6020020 | | |
| CENTRAL LIVE CONNECTOR | 6020017 | 6020018 | | |
| T CONNECTOR LEFT FAR SIDE EARTH | 6020027 | 6020028 | | |
| T CONNECTOR LEFT NEAR SIDE EARTH | 6020025 | 6020026 | | |
| T CONNECTOR RIGHT FAR SIDE EARTH | 6020023 | 6020024 | | |
| T CONNECTOR RIGHT NEAR SIDE EARTH | 6020021 | 6020022 | | |
| NEW SUSPENSION CENTRAL LIVE SUPPLY | 6020030 | 6020031 | | |
| NEW SUSPENSION LIVE END SUPPLY | 6020032 | 6020033 | | |
| NEW PENDANT CONNECTOR | 6020038 | 6020039 | | |
| CEILING SUSPENSION KIT | 6020042 | 6020043 | | |

ACCESSORIES FOR USE WITH CAN TRACK SPOTS ONLY

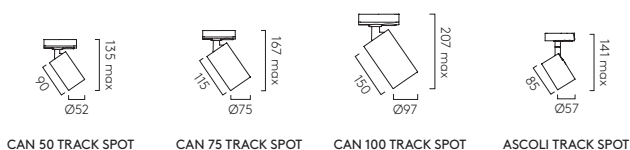

Please visit the tools section of our website to use the track configurator / Veuillez consulter la section outils de notre site Web pour utiliser le configurateur de rail. / Visitate la sezione accessori del nostro sito per accedere al Configuratore di binary. / Bitte besuchen Sie den Tools-Bereich unserer Website, um den Track-Konfigurator zu verwenden.

Includes removable glare guard FOR USE WITH CAN track spots ONLY

▼ Lamp excluded, see page 714 / La lampe exclu, voir page 714 / La lampadina esclusi a pagina 714 / Das Leuchtmittel ist ausgeschlossen, sie auf Seite 714.

LED





CAN 50 RECESSED (1396009)



CAN 50 RECESSED (1396008)



CAN

Includes removable glare guard

NEW

| | | | | LAMP | WATT | INPUT | K | CRI | Lm | CLASS | |
|-----------------|---------|---------|--|--------------|-------|------------|------|-----|------|-------|---|
| 50 SINGLE | 1396005 | 1396016 | | Integral LED | 7.7W | Mains 230V | 3000 | 80 | 502 | | ✓ |
| 50 TRIPLE ROUND | 1396006 | | | Integral LED | 22.6W | Mains 230V | 3000 | 80 | 1435 | | ✓ |
| 50 TRIPLE BAR | 1396007 | | | Integral LED | 22.6W | Mains 230V | 3000 | 80 | 1435 | | ✓ |
| 50 FOUR BAR | 1396013 | | | Integral LED | 30.3W | Mains 230V | 3000 | 80 | 1960 | | ✓ |
| 50 RECESSED | 1396009 | 1396008 | | Integral LED | 7.7W | Mains 230V | 3000 | 80 | 502 | | ✓ |
| 75 RECESSED | 1396010 | 1396011 | | Integral LED | 12.6W | Mains 230V | 3000 | 80 | 986 | | ✓ |

ACCESSORIES



CAN 50 BEZEL
6020008



CAN 75 BEZEL
6020016



CAN 50 SINGLE



CAN 50 RECESSED



CAN 75 RECESSED

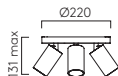

CAN 50 TRIPLE ROUND

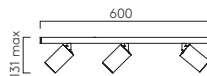

CAN 50 TRIPLE BAR

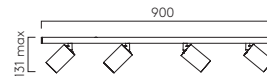

CAN 50 FOUR BAR





ASCOLI SINGLE (1286004)



ASCOLI TWIN (1286036)



ASCOLI RECESSED (1286023)



ASCOLI FOUR BAR (1286084)

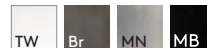

ASCOLI

| | | | | | | LAMP | WATT | CLASS | | |
|------------|------------------------|---------|---------|---------|---------|-----------|------------|-------|---|---|
| NEW | SINGLE | 1286001 | 1286004 | 1286015 | 1286078 | GU10 LED▼ | 6W max | | ✓ | - |
| NEW | RECESSED | 1286021 | 1286022 | 1286023 | 1286080 | GU10 LED▼ | 6W max | | ✓ | - |
| NEW | SINGLE SWITCHED | 1286010 | 1286009 | 1286011 | 1286079 | GU10 LED▼ | 6W max | | - | ✓ |
| NEW | TWIN | 1286034 | 1286035 | 1286036 | 1286081 | GU10 LED▼ | 2 x 6W max | | ✓ | - |
| NEW | TRIPLE ROUND | 1286002 | 1286005 | 1286012 | 1286082 | GU10 LED▼ | 3 x 6W max | | ✓ | - |
| NEW | TRIPLE BAR | 1286003 | 1286006 | 1286013 | 1286083 | GU10 LED▼ | 3 x 6W max | | ✓ | - |
| NEW | FOUR BAR | 1286007 | 1286008 | 1286014 | 1286084 | GU10 LED▼ | 4 x 6W max | | ✓ | - |
| NEW | FIVE BAR | 1286059 | 1286060 | 1286061 | 1286085 | GU10 LED▼ | 5 x 6W max | | ✓ | - |

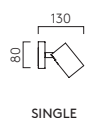

SINGLE



RECESSED

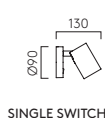

SINGLE SWITCHED

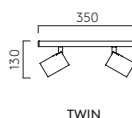

TWIN

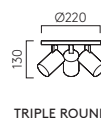

TRIPLE ROUND

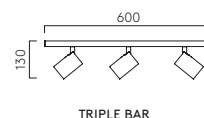

TRIPLE BAR

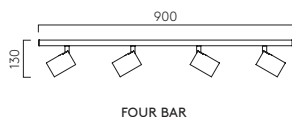

FOUR BAR

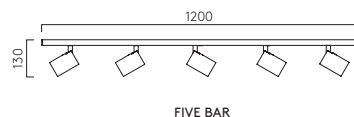

FIVE BAR

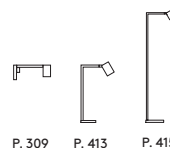

P. 309 P. 413 P. 415

▼ Lamp excluded, see page 714 / La lampe exclu, voir page 714 / La lampadina esclusi a pagina 714 / Das Leuchtmittel ist ausgeschlossen, sie auf Seite 714.

