

labyrinth³

maine
STORAGE INNOVATIONS





The agile workplace is designed with variety and choice in mind. Flexibility is at its heart and design options are key.

Labyrinth³ is the perfect workplace divider product for the agile working environment. With modular shelving, personal storage, seating, and planters, it is both versatile and functional.

Labyrinth³ is made up of a family of products and options. You can build your area divider solution to your perfect specification and then finish it with a mixture of metal, wood, glass, upholstery or even acoustic panelling and the matching stools are the perfect way to create a semi private breakout space. For a practical and innovative addition, why not add a writable whiteboard surface to your locker doors as well.

Finally, you can choose to populate the modules with biophilic elements to help great a calming space that contributes to both creativity, productivity, health and wellbeing.

LABYRINTH³

by Maine

Labyrinth³ is the perfect area divider solution for the agile workplace. Combining modular shelving, personal storage, seating, and planters, Labyrinth³ is a versatile and functional answer to today's modern interior.

Key features include :

- Integrated Locker options
- Retrospectively add 'cubes' to your configuration
- Shelving Units
- Seating
- Planters
- Tables
- Wood or metal finishes
- Glass shelf options
- Slim profile design
- Any RAL colour on metalwork

Shelving & Storage Dimensions

- Widths: 400mm
- Depth: 400mm
- Heights: 400 / 800 / 1200 / 1600 / 2000mm

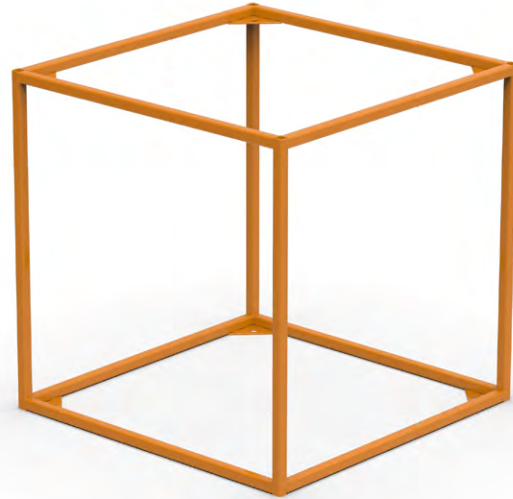

Paint Colours

Maine products can be specified in a wide variety of finishes including project specific and corporate colours.

Finishes can be normally specified from BS / RAL / Pantone or Dulux Colour Dimensions. Specialist paint finishes including metallic, polychromatic and pearlescent colours are available on request.

Maine's Powder Coat finishing plant employs the most contemporary technology to ensure a perfect finish.

For specific colour requests please contact Maine Office Customer Services:

sales@maine.co.uk

or call

01908 271 688



PW10001

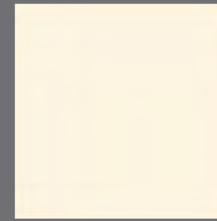

PC10106

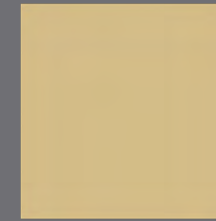

PC10108

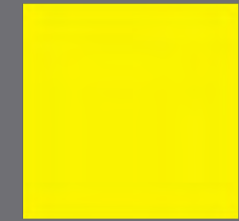

PY11020



PO10801



PO10810



PG10520



PS10603



PB10023



PB10024



PB10425



PG10239



PG10017

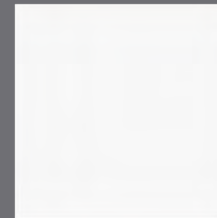

PW10005

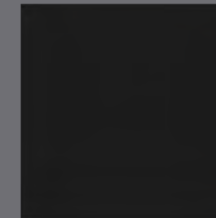

PB10709

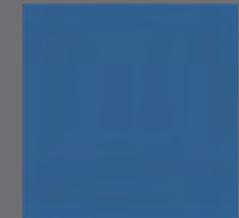

PB10437



PR10303

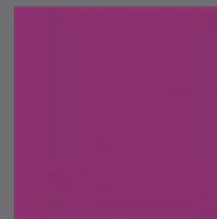

PB11102

Upcharge per additional colour on Labyrinth systems is £ 199 per colour

Wood Finishes

Labyrinth³ is available in a wide variety of coloured mfc & wood effect finishes.

These finishes can be applied to shelving units, lockers and planters.

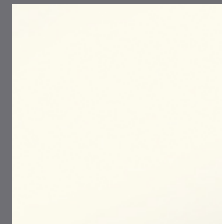

White W980



Sunshine 0134



Flame 7176

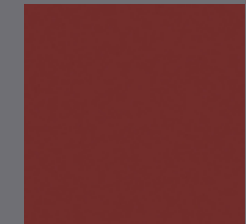

Oxide Red 9551

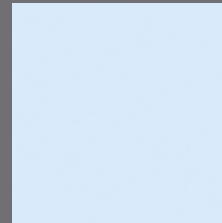

Sky Blue 7179

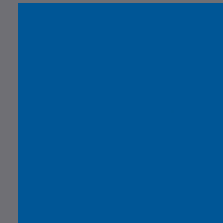

Royal Blue 0125



Lime Green 5519

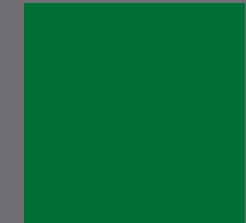

Oxide Green 9561

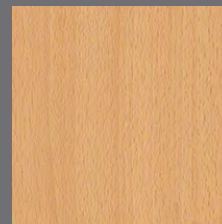

Beech H1582

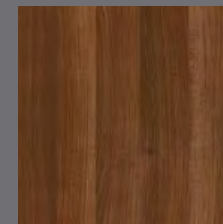

Walnut H3704

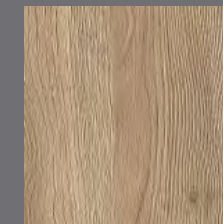

Oak H3326

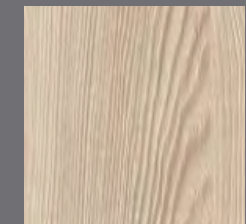

Ash H1250

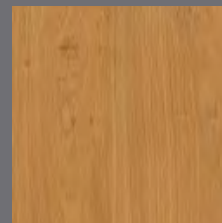

Oak H1381

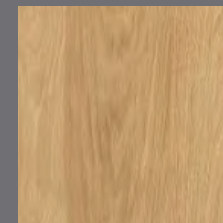

Hickory H3730



Denver Oak H1387

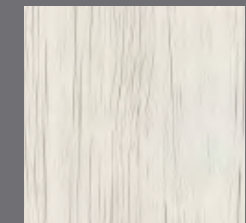

Whitewood H1122

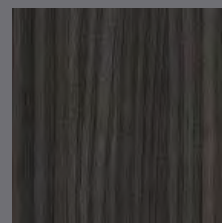

Black Pine H3081



Shorewood H3090

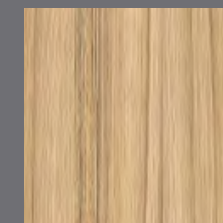

Coco Bolo H3012

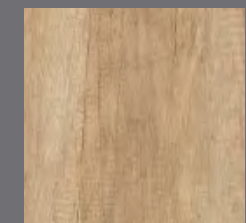

Natural Oak H3331

Minimum order quantities will apply for each finish type selected

Acoustic Panel Colours

The ability to add acoustic panels to your configuration not only provides a practical benefit in sound absorption but also gives you a chance to add another texture and colour to your interior project.

Our acoustic panels are lightweight but semi-rigid, made from compressed polyester felt that has endless design flexibility. In standard panel sizes with options of 12mm or 24mm thicknesses the panels work hard to reduce reverberation and control background chatter.

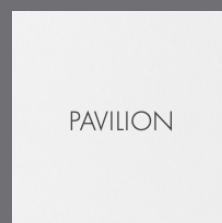
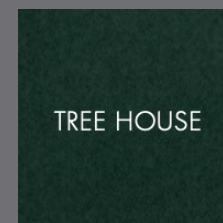
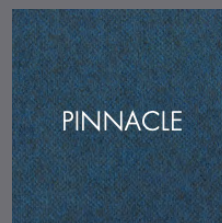
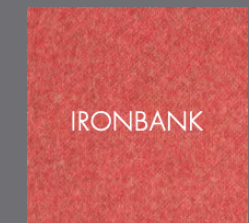
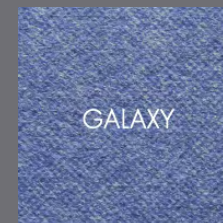
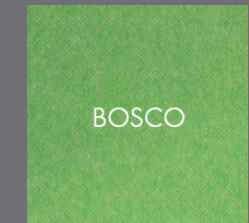
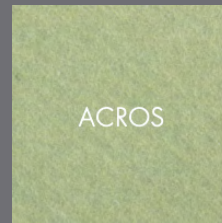
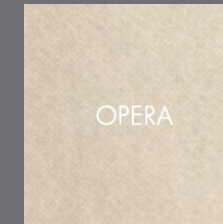
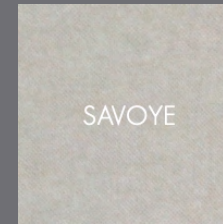

Minimum order quantities will apply for each finish type selected

Fabric

Xtreme

Seating options on Labyrinth³ are available in a wide selection of colours from the Camira Xtreme range of fabric.

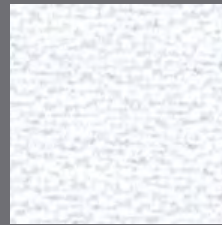

Adobo YS165

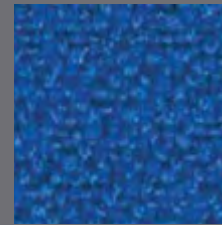

Honeymoon YS035

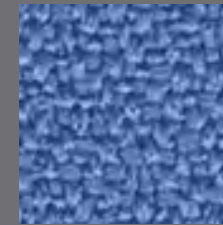

Bluebell YS097

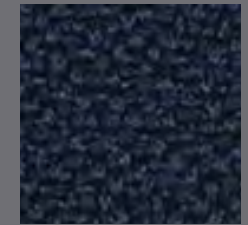

Costa YS026



Madura YS156

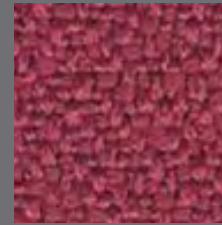

Diabolo YS101

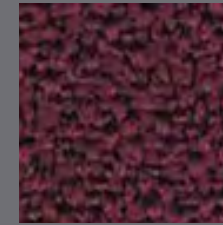

Tobago YS030

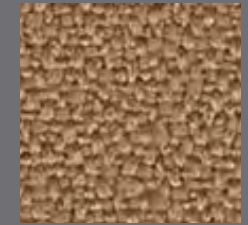

Sandstorm YS071

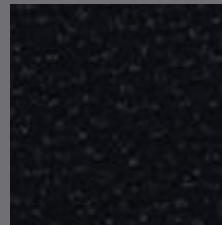

Havana YS009

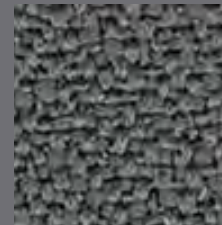

Blizzard YS081

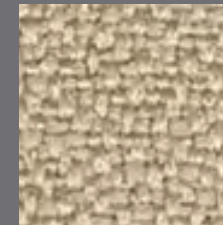

Aruba YS108

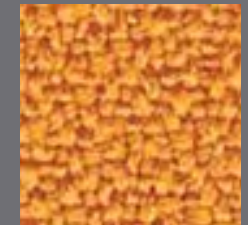

Solano YS072

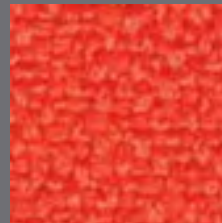

Tortuga YS168

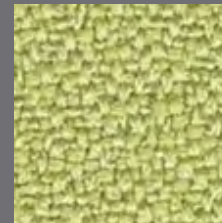

Apple YS096

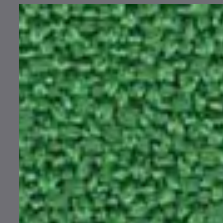

Lombok YS159

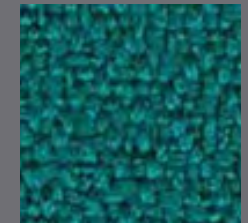

Tonga YS160

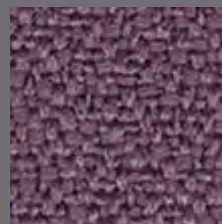

Bridgetown YS102

Minimum order quantities will apply for each finish type selected

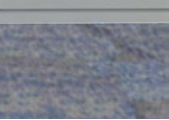
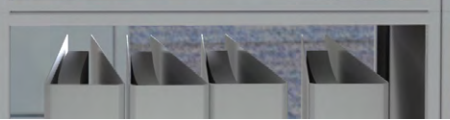

labyrinth³

pricing & options

LABYRINTH³

Specification Options

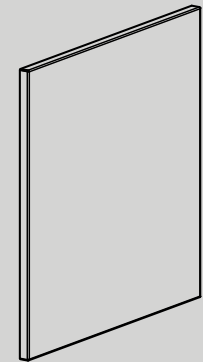
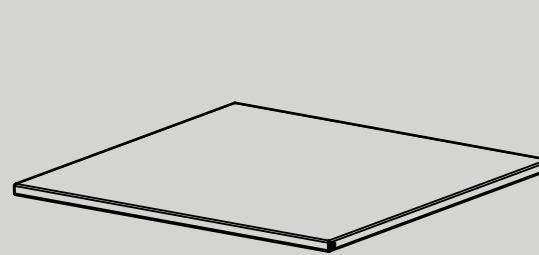
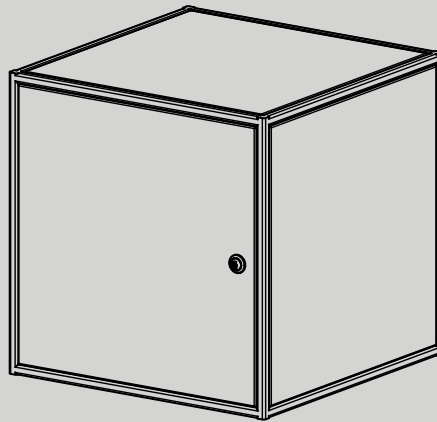
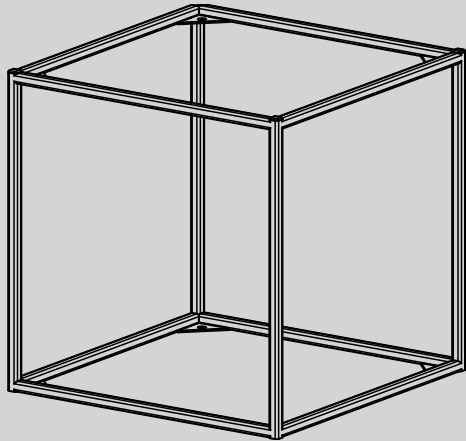

	Building Block (steel)	Locker (steel)	Metal Shelf (steel)	Side Panels (steel)
Size	400 x 400 x 400mm	400 x 400 x 400mm	400 x 400 x 10mm	400 x 400 x 10mm

LABYRINTH³

Specification Options

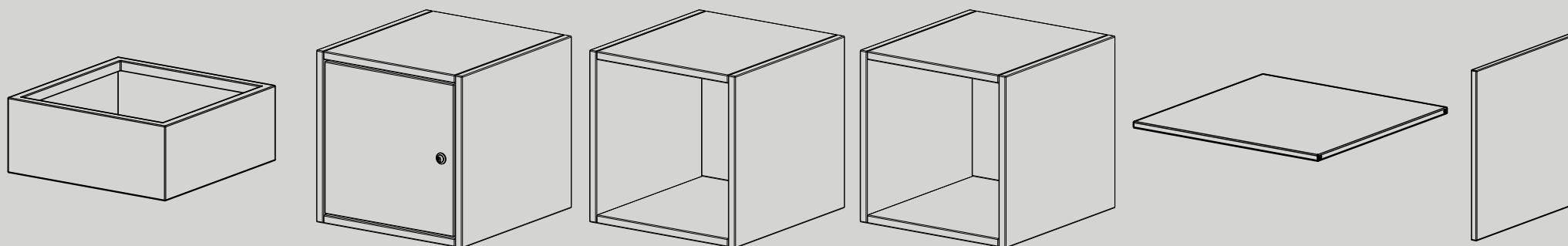

	Planter (mfc)	Locker (mfc)	Box (mfc)	Aperture (mfc)	Shelf (mfc)	Side Panels (mfc)
Size	400 x 400 x 170mm	400 x 400 x 400mm	400 x 400 x 400mm	400 x 400 x 400mm	400 x 400 x 18mm	400 x 400 x 18mm

* MFC shelf cannot be positioned at the very bottom or very top of each Labyrinth column

LABYRINTH³

Specification Options

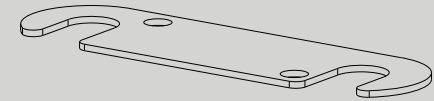
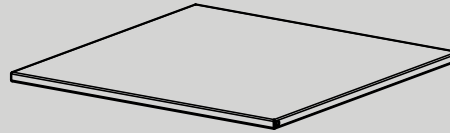
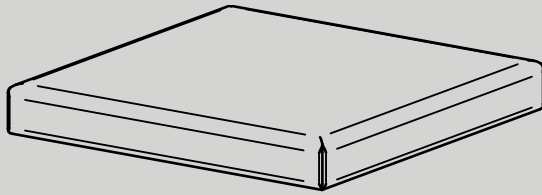

	Seat Cushion Camira Xtreme	Plain shelf (glass)	Ganging Plate
Size	400 x 400 x 50mm	400 x 400 x 10mm	-

LABYRINTH³

Specification Options

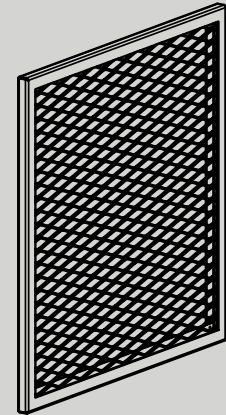
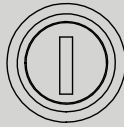
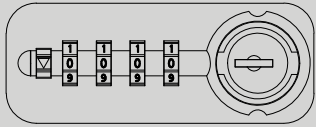

4 Digit Combination Lock

Key Cam Lock

Sound Deadening Side Panel

Mesh Side Panel

LABYRINTH³

Specification Options

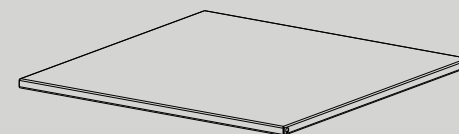
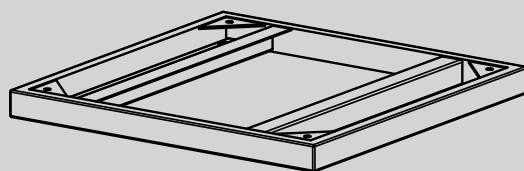
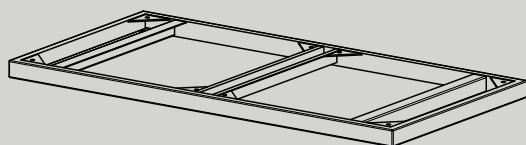

Double Plinth

Single Plinth

Counter Balance Weight (CBW)

LABYRINTH³

Specification - 2 Door Cupboards with blocks above

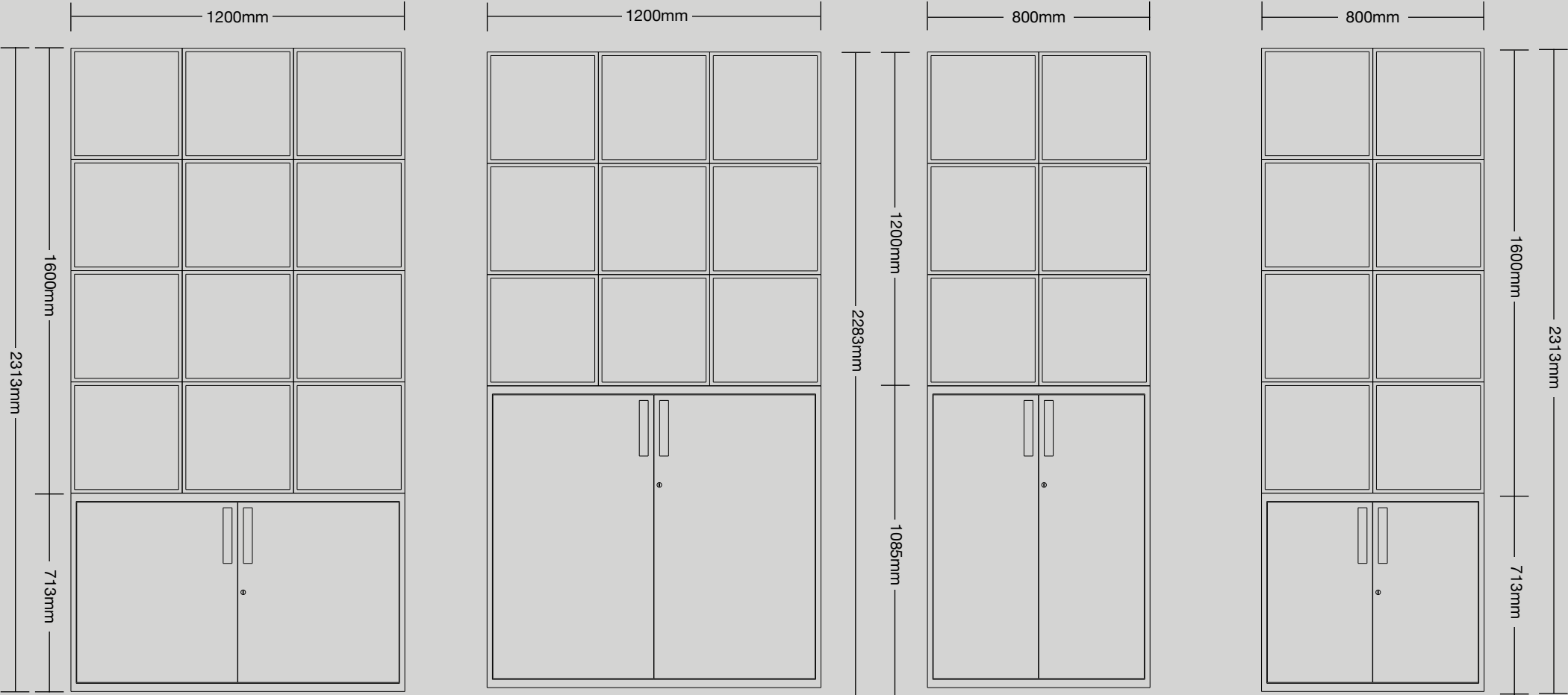

	12 Block Unit	9 Block Unit	6 Block Unit	8 Block Unit
Size	2313 x 1200 x 400mm	2283 x 1200 x 400mm	2283 x 800 x 400mm	2313 x 800 x 400mm

LABYRINTH³

Specification

Cupboard Units

Files A4 lever arch/box files and foolscap lever arch/box files

Capacity height 320mm

Unit width	Capacity	A4 lever arch per shelf
800mm	760mm	10
1000mm	960mm	12

Accessories

Ask for our accessories information for further internal options.

Material Steel
Finishes Powder coated
Colours RAL, Dulux, Pantone

Material Wood
Finishes MFC
Colours See page 5

Material Autex
Finishes Acoustic Panels
Colours See page 6

Material Fabric
Finishes Camira Xtreme
Colours See page 7

maine

STORAGE INNOVATIONS

tel: 01908 271 688 email: sales@maine.co.uk web: www.maine.co.uk

London Office

45 Great Sutton Street, London, EC1V 0DE

Head Office

40 Barton Road, Water Eaton Industrial Estate, Milton Keynes, MK2 3EF