

# ROMAN<sup>®</sup>

REFINED SHOWERING

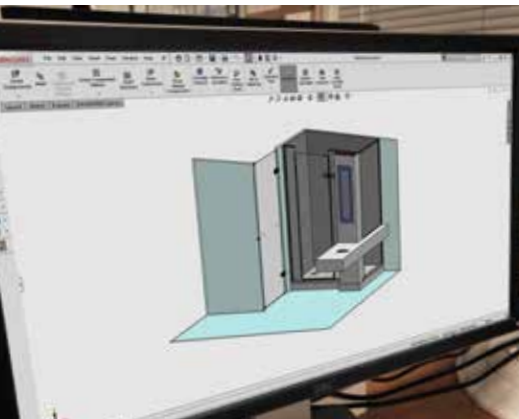

## PROJECT SPECIFICATION GUIDE

The essential showering guide for architects and developers worldwide



[www.roman-showers.com](http://www.roman-showers.com)



# CONTENTS

## MISSION STATEMENT



At the heart of Roman is the desire to be the best.

It is Roman's vision to lead and innovate in the Showering industry. To design and manufacture top quality inspirational showering solutions, which offers choice for all markets.

To expertly manufacture our products in Britain, so they are designed and built to last and offer a lifetime of effortless showering for all. It is our aim to give all our customers exceptional value and service; this ethos runs throughout the culture of the business and cannot be imitated.



### Welcome to Roman's Project Specification Guide.

This guide has been developed specifically for architects, designers and specifiers working on significant projects such as Hotel and Major Housing developments and Condominiums. Uniquely it allows you to pick and choose every single part of your showering solution, from your hinges and handle, to the bracing, seals and glass design. Roman also offer Solid Surface Fabrication manufactured to any specification required. Allowing you to build a bathroom concept to totally suit your individual project.

This Project Specification Guide offers a small sample of the options available to you. If the component you are looking for is not explicitly featured in this guide, please contact us as we have an almost infinite range available and are confident that we will be able to meet your needs.

An unrivalled array of job references are available upon request, see pages 14 - 17.

Who We Are	2 - 13
Project References	14 - 17
Mouldings and Fabrication	18 - 21
Glass Options	22 - 23
Metal Finishes	24 - 25
Circular Economy	26 - 28
Working with Pod Manufacturers	29
Leisure Solutions	30 - 32
Glass Protection	33
Anti-Slip Trays	34 - 35
BIM - <i>Building Information Management</i>	36 - 37
How to Order your product	38 - 39
Hinges	40 - 41
Bracket Fixings	42 - 43
Handle Options	44 - 45
Aluminium Wall Profiles	46 - 47
Bracing Systems	48 - 51
Sliding Door Systems	52 - 53
Sealing Systems	54 - 55
Accessories	56 - 57
Guarantee	58
Consumer Guide	59



## WHO WE ARE



In 2017 Roman was delighted to be awarded: The Queen's Award for Enterprise, International Trade.



Roman has had two Royal visits at our headquarters, for the company's 25th and 30th Anniversaries. These Royal visits recognise and celebrate our success as a UK Manufacturer, our growth in the UK and World Markets and our achievement of creating a trusted World Brand.



Roman has been designing and manufacturing showering solutions for over 35 years, and is home to the UK's largest manufacturing plant. All Roman products are designed and created in Britain, offering the ultimate in quality, precision and craftsmanship. Roman's diverse and versatile collection of products encompasses something for every style and shape bathroom - no matter what the budget.

Our foundations are strongly rooted in; innovative design, manufacture, quality and customer service. Innovation and exceptional product design, differentiates Roman from the competition. Roman employs a dedicated in-house Design Team, who add flexibility to our research and development.

Roman is a reputable and well established UK and European Brand, now supplying showering bathroom products all over the World. Our products are used in some of the finest hotels Worldwide.

Roman's key collections include Shower Enclosures; Bath Screens; Wetroom Panels; Walk-In Enclosures; Solid Surface Fabrication and Shower Trays.



Roman has been identified as one of London Stock Exchange's 1000 Companies to Inspire Britain. We are extremely proud to be recognised as one of the UK's fastest growing and most dynamic businesses.

We have been included in the London Stock Exchange's landmark report, which identifies the most exciting and dynamic small and medium sized enterprises. They state that these 1000 Companies to Inspire Britain have a unique capacity to innovate and create new jobs, in turn spearheading the revival of the UK economy.



EMS 523823



FS 523822

All Roman products are available on the Virtual Worlds design services and for project applications are available as a BIM file download. Making your product selection easier, Roman products are available on EQ software. For more information contact Customer Relations on 01325 328033 or visit: [www.roman-showers.com](http://www.roman-showers.com)

Roman have an ongoing policy of design, development and improvement. Thus reserve the right to modify specification and prices without prior notice.

 **AWARD WINNING**  
MANUFACTURING & INNOVATION

 **FULLY ACCREDITED**  
MANUFACTURING FACILITY

 **SUSTAINABILITY**  
PROMOTES CIRCULAR ECONOMY

 **INSPIRATION**  
TO DESIGN YOUR BATHROOM

 **GLOBAL BRAND**  
LUXURY HOTELS WORLDWIDE

 **CUSTOMER SERVICE**  
SALES & AFTERCARE

 **HIGH QUALITY MATERIAL**  
EXCEPTIONAL PERFORMANCE

 **GLASS**  
TOUGHENED SAFETY GLASS

 **SKILLED WORKFORCE**  
EXCEPTIONAL SERVICE

 **INCLUSIVE DESIGN**  
FOR ALL USERS REQUIREMENTS



## UK MANUFACTURER

All of our manufacturing processes are carried out at our UK Manufacturing Plant and Headquarters and meet and exceed approved UK and European testing standards.

By any definition Roman is now the clear UK Market leader, and perhaps more importantly for the North East of England, one of the few strong and genuine Manufacturers within the UK and European Bathroom Industry.

Roman has achieved this strong position in the Market Place by consistent and creative product innovation and has produced significant growth across all UK Market sectors and in the past 5 years, strong growth in International Markets. Roman's manufacturing capability and vast range of products has made the Brand increasingly strong in key International Markets.

Roman only use the finest quality of materials to guarantee unsurpassed quality and certainty in our manufacturing process, ensuring all of our products reach exceptional levels of style and performance.



## ALUMINIUM

At Roman we carefully design, extrude, fabricate and anodise all our aluminium profiles. We use aluminium because it is; light, strong and requires minimal maintenance. The anodising process increases corrosion resistance, product durability and further enhances the material properties. Our specialist anodising offers a bright chrome like finish which is significantly in excess of standard aluminium finishing.

This aluminium capability is unrivalled and offers limitless design options.

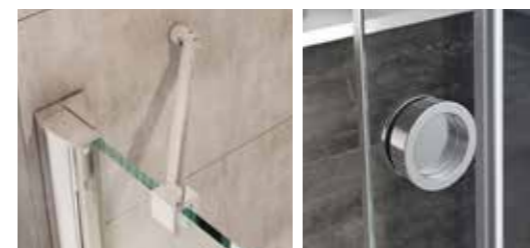

## COMPONENTS

We offer an extensive collection of components including different colours, shapes and styles to create your own bespoke look. Great care and attention is paid when choosing each component, to ensure they are of outstanding quality, right down to the finer detail.



## GLASS

We carefully select our glass suppliers and all our enclosures feature toughened safety glass. This is a heat treatment to increase the glass strength to make it around 5 times stronger than normal glass. If the glass were to break due to impact, it would shatter into lots of small pieces which are much less dangerous and will help avoid any cuts or injury. All glass is strictly tested in accordance with EN 14428.

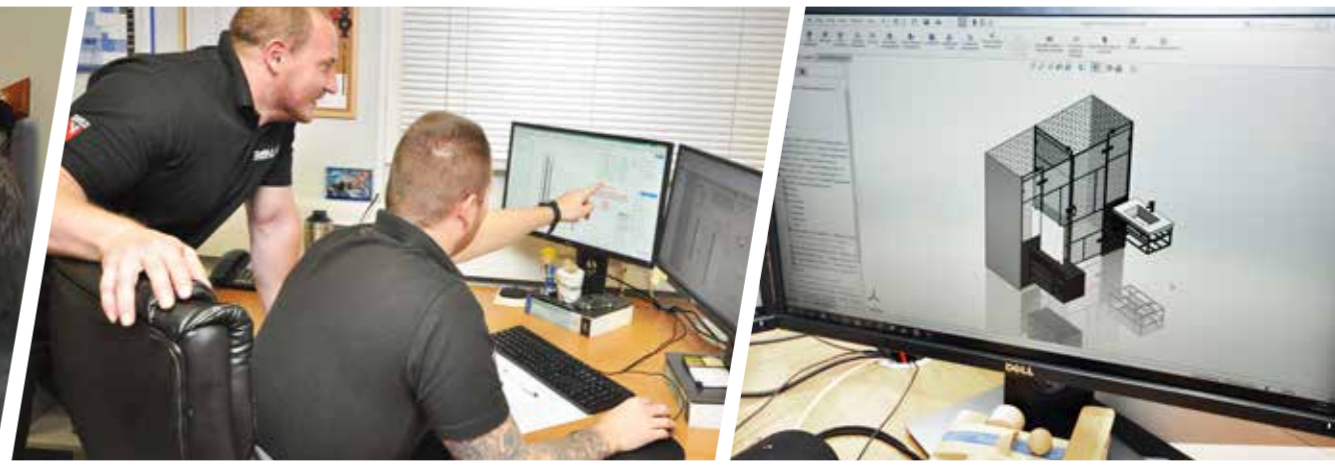

## AWARD WINNING MANUFACTURING & INNOVATION

Innovation and exceptional product design differentiates Roman from the competition.

Roman employ a dedicated in-house Design Team who are based at our purpose built Design Centre. They add flexibility to our research, development and innovation.

Roman's key collections are available in BIM, CAD, Virtual Worlds and EQ Software. Our Design Team are leaders in innovation and design and can provide accurate technical CAD drawings from customers' requirements and drawings, bringing their design ideas to life.

Our products and ranges have won multiple awards for innovation and manufacturing including; the Queens Award for International Export in 2017 and most recently NHIC for bathroom safety compliance in 2018.

Roman is experienced in large Project work and frequently create bespoke solutions to suit individual customers' briefs.

Our products are carefully designed for all. We consider different users' needs to give totally effortless entry to the entire family. Whether you would like door-less entry, level access, handles that can be used with a flat hand or a wider aperture, we have something that will work with your space all finished with a stylish designer look.



## PROJECT PLANNING - WORKING WITH YOU

We have a friendly and helpful team at Roman, who are on hand to offer their skilled and expert knowledge, ensuring you get exactly what you're looking for with detailed advice and support throughout. The Roman Team will work with you every step of the way, from the initial design drawing to providing technical advice, and from delivery to after sales support.

We use state of the art 3D printers for modelling and testing components for accuracy before going into production and we have A1 inkjet printers to enable the team to work accurately from Architects scaled plans.

Roman has also invested in BIM (Building Information Modelling) and our key collections of Shower Enclosures, Wetrooms, Walk-in Enclosures and Shower Trays are now available in the BIM format. For more information please see pages 36 - 37, the download files are available from: [www.roman-showers.com](http://www.roman-showers.com)



# PRODUCTION FACILITIES

The Roman Production Team makes sure that each and every product is made with precision and accuracy. We use the latest technology to ensure efficiency and speed and we have the best skilled workforce to make sure each stage of the manufacturing process goes to plan. We are constantly investing to develop, expand and quality enhance our manufacturing operations, as demand is rapidly increasing.

Roman's UK manufacturing and production facilities are spread across four different manufacturing plants, totalling over 200,000 square feet. There is the main manufacturing plant for shower enclosures; wetroom panels; and bath screens. A specialist solid surface manufacturing plant for shower trays including our unique Anti-Slip shower trays. Our solid surface fabrication manufacturing plant for vanity units, basins and bathroom structures. There is also a specialist international despatch area to cater for the large project work we despatch all over the world.



## CUSTOMER SERVICE

Our dedicated Customer Services Team is based at our headquarters in North East England. We ensure that each member of the team is extensively trained to provide them with in-depth knowledge of the manufacture and installation of Roman's collection of products.

This team are here to support each purchase at every stage; from initial enquiry through to after sales care and advice. Roman employs over 20 full time members of staff in our Customer Support Centre.



ROMAN IS A REPUTABLE AND WELL ESTABLISHED UK BRAND  
 NOW SUPPLYING SHOWERING SOLUTIONS ALL OVER THE WORLD

## ROMAN HEADQUARTERS

**Roman Limited,**  
 Whitworth Avenue,  
 Aycliffe Business Park,  
 County Durham,  
 DL5 6YN  
 United Kingdom

GENERAL RECEPTION:  
 Tel: +44 (0) 1325 311 318  
 ukprojects@roman-showers.com

## IRELAND

**Roman Ireland**  
 W10F  
 Ladytown Business Park  
 Naas  
 County Kildare  
 Ireland

IRELAND SALES:  
 Tel: +353 (0) 45 408 118  
 irelandsales@roman-showers.com

## ASIA PACIFIC

### Factory/Office

Roman Asia Sdn. Bhd (091603K)  
 No.6, Jalan Olivin,  
 Taman Industri Sungai Purun,  
 43500 Semenyih,  
 Selangor Darul Ehsan,  
 Malaysia

### ASIA SALES:

Tel: +60 (0) 3 8723 1211  
 romanasia@roman-showers.com

### A&D Showroom Asia

Cosentino Centre Kuala Lumpur - Malaysia,  
 Jalan TSB 8,  
 Taman Industri Sungai Buloh,  
 47000 Petaling Jaya,  
 Selangor,  
 Malaysia

## KEY CONTACTS:



### GRAHAM SPEED:

Commercial Director  
 English  
 Mob: +44 (0) 7870 556825  
 Tel: +44 (0) 1325 327962  
 g.speed@roman-showers.com



### EMILIA PLAZA GÓMEZ:

International Sales Manager  
 Spanish, English, Italian  
 Mob: +44 (0) 7887 643164  
 Tel: +44 (0) 1325 327740  
 e.plaza-gomez@roman-showers.com



### LILA POUDRÉ:

International Sales Manager  
 French, English, Spanish  
 Mob: +44 (0) 7725 768351  
 Tel: +44 (0) 1325 327989  
 l.poudre@roman-showers.com



### PAUL HYDE:

UK & International Specification Manager  
 English  
 Tel: +44 (0) 7792 558810  
 p.hyde@roman-showers.com



### HEIKE HAMILTON:

International Sales Manager  
 German, English  
 Mob: +44 (0) 7813 014442  
 Tel: +44 (0) 1325 327992  
 h.hamilton@roman-showers.com



### CHARLENE POON:

Asia Pacific Specification Manager  
 English, Chinese Dialects  
 Mob: +60 (0) 16 983 8841  
 c.poon@roman-showers.com



USED IN SOME OF THE FINEST  
**HOTELS WORLDWIDE**

Roman is the leading UK and European shower manufacturer and as such our dedicated International team are vastly experienced in dealing with large projects overseas and frequently create bespoke solutions to suit individual customers' briefs. The multi-lingual department has specialist members of staff who speak a number of languages between them, including English, Spanish, French, German and Italian.

We have worked on Projects Worldwide, most notably across Europe, the Americas, Asia Pacific and the Middle East. Our products are manufactured in our UK headquarters, Roman also have a showroom and manufacturing facility set up to serve the Asia Pacific market, Roman Asia, which is based in Kuala Lumpur..



## PROJECT REFERENCES HOTEL & PROJECTS

### IHG®



- UK**
- Belfast
  - Harrogate
  - Marlow
  - Newcastle-Upon-Tyne
  - Plymouth



- UK**
- Ashford
  - Birmingham
  - Hemel Hempstead
  - Inverness
  - Leicester
  - Manchester West
  - Reading
  - Shepperton
  - Stratford

- IRELAND**
- Dublin



- UK**
- Brighton
  - Cardiff
  - Chester
  - Dundee
  - Leicester
  - Bath



- UK**
- Edinburgh



- UK**
- Cardiff Bay
  - Edinburgh
  - Glasgow
  - Oxford
  - Solihull
  - Thames



- UK**
- Barrow-in-Furness
  - Belfast
  - Birmingham
  - Burton Upon Trent
  - Canterbury
  - Cardiff Bay
  - Cheltenham
  - Croydon
  - Dunfermline
  - Edinburgh City Centre
  - Edinburgh Royal Mile
  - Gibraltar
  - Glasgow
  - Inverness
  - Leicester
  - London Earls Court
  - London Park Royal
  - Oxford
  - Perth
  - Stirling
  - Stratford
  - Strathclyde
  - Swindon
  - Victoria
  - Walsall
  - Watford
  - Wigan

- FRANCE**
- De Lormont
  - Nice

- IRELAND**
- Derry
  - Dublin

**MALTA**

- St George's Bay

- SWITZERLAND**
- Zürich



- UK**
- Leicester



- UK**
- Barking
  - Coventry South
  - Coventry
  - Heathrow
  - Derby
  - Swansea
  - Hounslow
  - Liverpool
  - Manchester
  - Swindon
  - Thurrock

- DUBAI**
- Dubai



- UK**
- Leeds
  - London Excel
  - London Gloucester Road
  - Reading
  - Southwark



- UK**
- Aberdeen
  - Bristol
  - Cardiff
  - Cheltenham
  - Dartford, Brands Hatch
  - Haydock
  - Leeds Centre
  - Liverpool
  - Windsor

- FRANCE**
- Brive
  - Le Coudray-Montceaux
  - Perpignan



- UK**
- Birmingham Airport
  - Edinburgh
  - Leeds
  - Leicester
  - London Canary Wharf
  - London City South
  - London Excel
  - London Heathrow
  - London Tower Bridge
  - London Waterloo
  - Manchester
  - York

- BELGIUM**
- Ypres

- FRANCE**
- Annecy
  - Gardenia
  - Montparnasse
  - Nice
  - Orleans
  - Paris Orly
  - Paris Porte de Versailles
  - Paris Roissy en France
  - Strasbourg
  - Tours

- GERMANY**
- Hamburg

- ITALY**
- Milan

- NETHERLANDS**
- Amsterdam

- NIGERIA**
- Lagos

- SPAIN**
- Madrid
  - Seville

### Hilton



- UK**
- Birmingham Royal Angus
  - Kensington Queens Gate
  - Nottingham
  - Oxford Belfry
  - Sheffield



- UK**
- Blackpool
  - London Ealing

- GERMANY**
- München

- NETHERLANDS**
- Poortgebouw Utrecht



- UK**
- Dublin
  - Leeds
  - Nottingham
  - London Paddington
  - London Tower Bridge
  - London West End
  - Woking

- CROATIA**
- Imperial Dubrovnik

- GERMANY**
- Kiel



- UK**
- Abingdon Oxford

- DENMARK**
- Faroe Islands

### NATIONAL HOUSE BUILDERS



Currently specified by over 100 UK House Builders

### UK PROJECTS

Roman is a leading UK shower manufacturer and as such we are experienced in large Project work and frequently create bespoke solutions to suit individual customers' briefs. Listed below are some of the many projects we have worked on;

- Affinity living / Vita Student
- Aldgate Tower
- Barking Riverside
- Bickenhall St.
- Bryanston Court
- Canto Court, London
- Elephant & Castle Residential
- Exeter University
- Gatecrasher University
- Killerby Hall
- Newcastle University
- Oasis Holiday Village
- Oisin House
- Pembroke College, Dolby Court
- Princess Yachts
- Project Trinity, Dublin
- Renslade House Exeter
- Sloane Club London
- St. Georges London
- Sunderland University
- Texaco Building
- Wapping Riverside
- West Cliff Leisure Area
- Western Gateway
- Westgate House

Roman's International team work closely with distribution and retail partners all over the world. The team has worked on a number of diverse Hotel, Residential & Hospitality Projects, which have been undertaken in a variety of different countries.

Project References are constantly being updated, if you require a full list of projects completed please contact a member of our international team (details can be found on the previous page).

### OTHER BRANDS



- UK**
- Dublin
  - Manchester Airport
  - Stansted Airport



- UK**
- Exeter
  - St Andrews



- UK**
- Brighton
  - Liverpool
  - Manchester
  - Newcastle-Upon-Tyne



- UK**
- Belfast City
  - Cork South Mall
  - Dublin Kevin Street
  - Newcastle



- UK**
- Cork Silver Springs
  - Dublin Airport
  - Dublin Ballsbridge
  - Dublin Charlemont



- UK**
- London Heathrow
  - London Maida Vale
  - London Moxy Hotel Slough
  - London Regents Park
  - Manchester Airport
  - Oxford



- UK**
- Piccadilly



- UK**
- London Bermondsey
  - London Earls Court
  - London Long Lane



- UK**
- Cardiff
  - Dudley
  - Leeds
  - Newcastle
  - Nottingham
  - Wirral



- UK**
- Clerkenwell
  - Edinburgh
  - Glasgow
- USA**
- Miami





## PROJECT REFERENCES INDEPENDENT HOTELS & PROJECTS

### UK & IRELAND

#### UK

- Alhambra Hotel, London, UK
- Badgers Brook, Wales, UK
- Baileys Millennium Hotel, London, UK
- Barnsley House, Barnsley, UK
- Battersea Rise, London, UK
- Brighton House Hotel, Brighton, UK
- Cairn Station Aberdeen, UK
- Canada Lodge and Lakes, Cardiff UK
- Canada Water - Project Light, London, UK
- Canto Court, London, UK
- Cedars, Green King, Devon, UK
- Charter Place, Uxbridge UK
- Chilworth Manor, Southampton, UK
- Corn Exchange Manchester, UK
- Cottons Hotel, Cheshire, UK
- Crerar Deeside Inn, Scotland, UK
- Elgin Crescent, London, UK
- Formby Hall, Liverpool, UK

- Grantley Hall Ripon, UK
- Great Portland Street, London, UK
- Hogarth's Stone Manor, Worcestershire, UK
- Hotel Gotham, Manchester, UK
- Kingston University, London, UK
- Lengard Ltd, Kew Gardens, UK
- Liberty Point Student Accommodation, UK
- Lygon Arms, Worcestershire, UK
- Midland Hotel, Morecambe, UK
- Monkey Island Estate, Berkshire, UK
- Mottram Hall, Mottram, UK
- North Queens Ferry, UK
- Old Thorns Golf & Country Club, Liphook, UK
- One The Brayford, Lincoln, UK
- Oulton Hall, Leeds, UK
- Paramount Hotel, Nottingham, UK
- Q Hotels, Dunston, UK
- Redworth Hall, Newton Aycliffe

- Roxburghe Hotel & Golf Course, Scotland, UK
- Royal Arden Hotel, Stratford-upon-Avon, UK
- Royal British Hotel, Edinburgh, UK
- Royal Holloway, London, UK
- Slaley Hall, Hexham, UK
- St Gillies Hotel London North, UK
- Tewksbury Hotel, Tewksbury, UK
- The Grand Hotel York, York, UK
- The Grove, Gosforth, UK
- The Lensbury, Middlesex, UK
- The Lowry Hotel, Manchester, UK
- Trinity Riverside Manchester, UK
- University Arms Hotel, Cambridge, UK
- Wentworth Homes, Surrey and Berkshire, UK
- Western Gateway, London, UK
- White Horse Hotel Dorking, UK

#### IRELAND

- Ballymun, Dublin, Ireland
- NIAS, Enniskillen, Northern Ireland
- Oisín House, Dublin, Ireland
- Project Trinity, Ballsbridge, Dublin, Ireland

- Qub Student Accommodation, Belfast, Ireland
- Queens University, Belfast, Ireland
- Royal Belfast Golf Club, Belfast, Ireland
- The Mespil Hotel, Dublin, Ireland

- The Old Ground Hotel, Ennis, Ireland
- The Windsor Hotel, Belfast, Ireland

### INTERNATIONAL

#### ABU DHABI

- Bateen Marina Resort Development
- Capital Plaza Hotel
- Lea Hotel
- Luxurious Residential Tower

#### DUBAI

- Jumeirah Residences
- Lotus Hotel
- Tijara Town

#### FRANCE

- Chantier Beaulieu, Nice
- Gare St Roch, Montpellier Appart'City
- Hôtel Amiraute, Ajaccio, Corsica

#### GIBRALTAR

- Waterport Terrace, Gibraltar

#### HONG KONG

- Hing Shing St. Project
- Kau to Shan 108
- Man on Shan 338,
- Tuen Mun 4C
- Vianni Cove Project, Tin Shui Wan

#### ICELAND

- Guldsmeden Hotels, Reykjavik
- Hotel Geysir, Iceland

#### KINGDOM OF TONGA

- Reef Resort Vava'u Hotel

#### MALAYSIA

- 9 Seputih Condominium, Kuala Lumpur
- ARIA project KLCC
- Damai 88, Kuala Lumpur
- Geo 88 Condominium, Gotong Jaya
- Glenmarie, Kuala Lumpur
- Hap Seng KLCC (Alia)
- Laguna, Langkawi
- Meru Semi-D Residents, Ipoh
- Pacific City, Kota Kinabalu
- Pengalan Super-Link Residents, Ipoh
- Peony Square Condominium Cameron Island
- Petronas Cabin Houses Rapid, Johor
- Taman Pengkalan Tiara, Ipoh
- The Grib Condominium, Kuala Lumpur
- Wariasi Villa Condominium, Cameron Highlands
- Zinma Residents Bungalow

#### MALTA

- Corinthia Hotels

#### NIGERIA

- Citilodge Hotel
- Victoria Mall Plaza, Lagos

#### OMAN

- Mahfooth Al Ardhi Sohar Club,
- Medinat Al Alam Villa, HE Mohammed Bin
- New Royal Palace, Muscat

#### POLAND

- City Park Hotel, Krakow
- Wolverton Park, Warsaw

#### QATAR

- Al Tawadi
- Al-Tayeb Villa Project
- Al-Wadji Palace, Doha
- Maryam Al Kuwari
- Villa Project, Doha

#### ROMANIA

- Hotel Laki, Mamaia

#### SPAIN

- Club Vista Verde Holiday Village, Maspalema
- Hotel Campo Des Las Naciones, Madrid

#### TURKEY

- Feza Apartaments Istanbul



Featured on  
**GRAND  
DESIGNS**

# MOULDING & FABRICATION

Roman has been at the forefront of Solid Surface technology for 18 years.

Roman has a long established Solid Surface (engineered Stone) Moulding Plant on its main manufacturing site within our head office. This facility includes rapid prototyping; CNC precision mould making; a large variety of different moulding methods for our extensive range of shower trays; and a huge oven and fabrication area for the highest quality finishing. Having the mould manufacturing in-house gives flexibility in terms of lead times and costs of moulds - depending upon the particular application and volumes of trays.



## AREAS OF USE

- Fitted bathroom furniture
- Hotel bathroom fittings
- Updating work surfaces
- Leisure / spa facilities
- Table tops for restaurants / hotels

Roman Stone shower trays are manufactured from solid surface and are inherently anti-slip and carry the highest international standard of **DIN Class C**.

Since 2014 Roman has added Solid Surface fabrication to this facility. This allows precast Solid Surface sheets (of any thickness required) to be fabricated to precise Project requirements wether this be a small basin unit through to a full height pod unit. This includes hidden joints, hidden fixings and any corner or finishing details required. These fabrications can be designed to suit any requirement and the fabrications can be as flexible as the material itself. Any structural or reinforcement requirements can also be supplied in whatever material and whatever strength specified.

If you submit drawings, or simply ideas, we would be delighted to offer you bespoke quotations and design ideas to suit your specification and ambitions.

## BENEFITS:

- Seamless design - no grooves or edge work, presenting a completely flawless look
- Highly resistant to staining and discolouration
- Anti-bacterial

The extensive range of finishes including Concrete, White Fleck, Grey and Marbled effect, moves interior design specification to a new level.



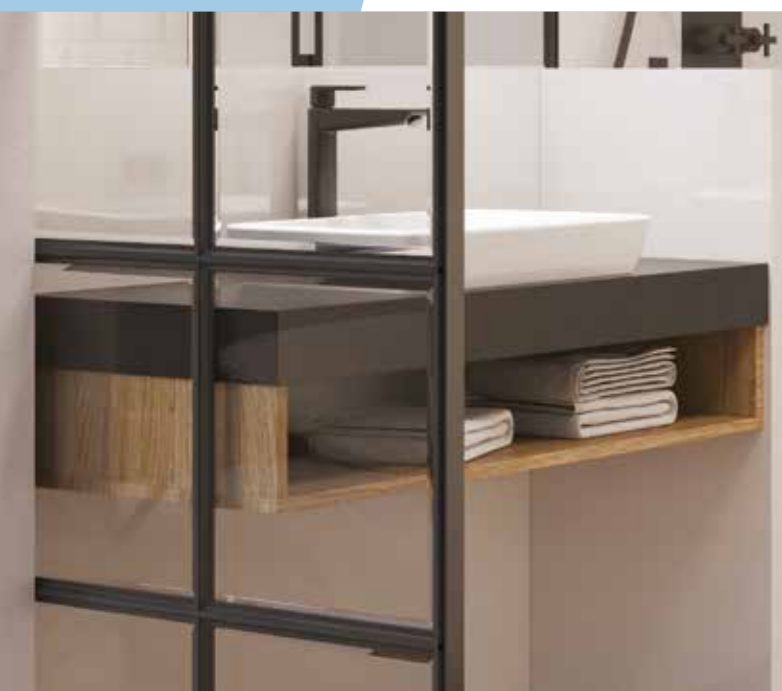

## BESPOKE VANITY UNITS

- Solid surface vanity units and other bespoke fabrications available
- A huge range of colours and finishes
- Available with and without undermount sink
- Shape options for undermount sinks, including bespoke shapes
- Solid surface products can be combined with other materials to create towel shelves and other features
- All products created from initial drawings



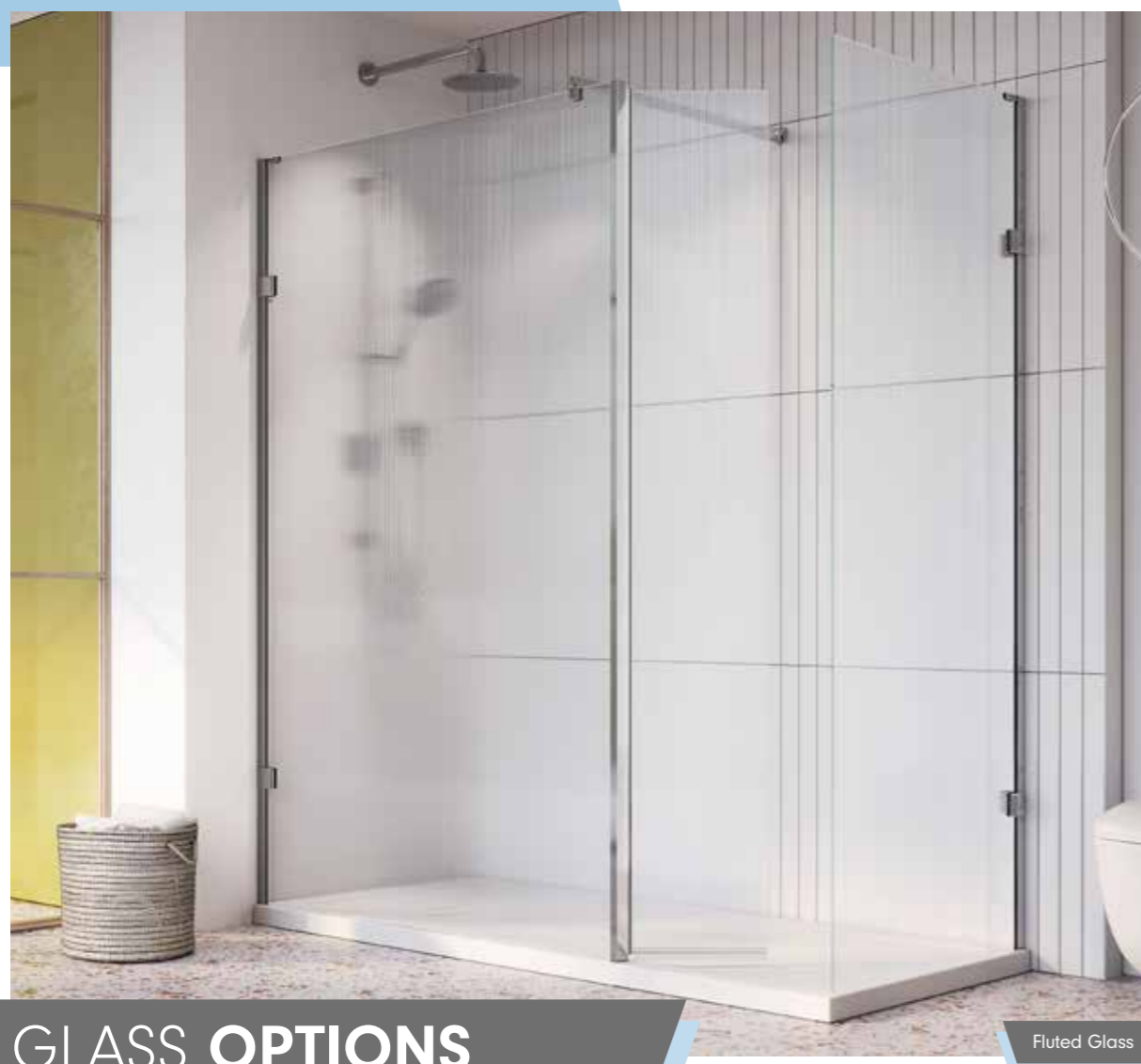

Fluted Glass

## GLASS OPTIONS

You can choose any glass finish you would like including clear, frosted, patterned and digitally printed glass. If you are looking for a specific design or motif to be added to the glass, we can accommodate this. We can also offer low iron, mirrored, curved or heat soaked glass. A large variety of coloured glass "tints" can also be produced if desired.

Let us know what glass thickness you would like. The standard on these styles of products is 8mm and 10mm thick glass, but we can work within your requirements. Across our series of standard enclosures we offer 4mm to 10mm thick glass products, so we regularly work with all of these thicknesses. We can advise as required.

- All Roman Bath Screens and Enclosures are manufactured using toughened safety glass which complies to BSEN12150 (EN14428 when curved).
- All Roman Bath Screens and Enclosures are tested in accordance with BSEN14428 - shower enclosures, functional requirements and test methods.
- Roman's toughened glass is completely safe for use in our shower enclosures and bath screens; providing our products are installed according to our guidelines.



Standard Glass

Low Iron Glass



Printed Glass



Mirrored Glass



Frosted Glass



Cut / Shaped Glass



Silk Screen Printed Glass



Curved Glass



## METAL FINISHES

## COLOURS

In addition to the multitude of colour and finish options available in glass and Corian, Roman can also now offer a choice of 10 colour options for metal finishes.

There are 5 colours stocked as Standard

- Brushed Brass
- Brushed Nickel
- Polished Black Chrome
- Polished Chrome
- Polished Nickel

However, working with our market leading partners in Brassware, we have developed a further 5 for the Project marketplace.

We have carefully matched the aluminium extrusions to coordinate as closely as possible with the Brassware finishes and although being different materials and very different manufacturing processes, the end result is a huge and unrivalled range of stunning complementary finishes.

These finishes are for major developments and Projects only and therefore volumes and lead times are to be agreed on a project by project basis. Any extra colours can be produced upon request to agreed volumes.

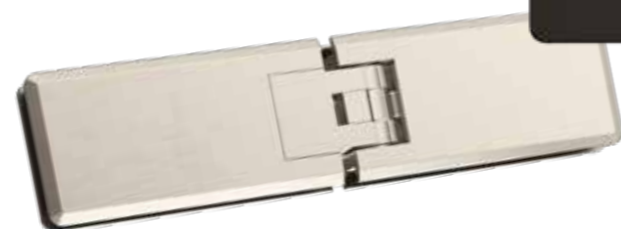

Polished Chrome



Brushed Chrome



Polished Nickel



Brushed Nickel



Polished Brass



Brushed Brass



Polished Gold Optic



Brushed Gold Optic



Polished Black Chrome



Brushed Black Chrome

# CIRCULAR ECONOMY

**constantly working with our suppliers to maximise the use of recycled materials**

Roman is constantly working with our suppliers to maximise the use of recycled materials. The principles of the circular economy are embedded in all of our design and purchasing policies and plans.

All Roman's aluminium and packaging is manufactured using 100% recycled material before we use it in our manufacturing process. All other materials used in the manufacturing of our products are also at high levels of recycled material. Our packaging is fully environmentally friendly with no wood or polystyrene used and is therefore itself 100% recyclable.

ROMAN HAS THREE CORE ENVIRONMENTAL OBJECTIVES:

- 1 Reduce energy consumed as a direct proportion of business activity.
- 2 Increase the proportion of recycled waste.
- 3 Reduce and if possible eliminate any harmful emissions, discharges or pollutants generated by the business activity.





## SUSTAINABILITY

Looking after the environment is an integral part of being a modern UK manufacturer and as a business we are continually striving for improvement and to exceed environmental targets - with the ultimate aim of becoming carbon neutral.

For more information on our environmental programme visit our dedicated environmental page on our website [www.roman-showers.com](http://www.roman-showers.com)



## PROTECTING THE ENVIRONMENT

Roman is totally committed to a very progressive environmental programme with ISO 14001 which targets waste reduction; improvement of resource efficiency; constant measurement and reviewing of environmental impact; and managing and improving environmental obligations.



EMS 523823

**93%**  
OF ALL WASTE  
IS RECYCLED

**LANDFILL 7% OF TOTAL WASTE REDUCED** **GENERATED**

**ALL WASTE IS SEGREGATED INTO RECYCLABLES & NON-RECYCLABLES**



All Roman Shower Enclosures, Bath Screens and Trays are manufactured in the UK.

All vehicles are Euro 6 compliant with our car fleet having average CO<sup>2</sup> emissions of 114 kg/km.

Overall Roman have reduced the CO<sup>2</sup> emissions from business activity by 30% since 2009.



All Roman brochures and marketing material are printed on stock sourced from responsible forests.

### RECYCLING YOUR PRODUCT

#### Packaging

As an ISO14001 Registered Company, Roman takes recycling very seriously at all levels. All cardboard is already manufactured from recycled paper, but our packaging itself is designed for recycling. Please ensure that the cardboard packaging is taken to a local cardboard recycling point or to a local recycling depot.

#### End of Life (EOL)

EOL recycling is taken into account from the initial design stages to ensure all aspects of the Roman products can be recycled for future use. The Aluminium, Brass Alloys, Glass (and Solid Surface Material with Roman Stone Trays) can be easily recycled at your local Licensed Recycling Centre (LRC). If you are unable to access an LRC, then Roman can arrange to coordinate a pick-up of your product for a modest transport charge.



## WORKING WITH POD MANUFACTURERS

Offsite manufacturing is now a significant part of the construction chain in almost every developed market around the world. Roman have been dealing with Pod manufacturers for many years and we are well versed in their specialist installation requirements - and often delivery requirements. We work with a wide range of Pod manufacturers on four continents.

We also work with other specialist manufacturers such as caravan or yacht manufacturers. Our bespoke capabilities can cater for all such needs and requirements whatever the volume or complexity.



Hotel built using off-site manufactured pods





## LEISURE SOLUTIONS

Due to our unique manufacturing capability we're delighted to introduce an addition to our bespoke product service - Roman Leisure Solutions.

Our Leisure Solutions are ideal for hotel spas and leisure complexes for modest showering and changing cubicles. There is a range of hardware available including locks; towel rails; and robe hooks, along with glass options such as frosted or patterned. We offer flexibility in size, design and number of cubicles. This new concept has been developed specifically for architects, designers and specifiers working on significant projects. Uniquely it allows you to pick and choose every single part of your product solution, from your hardware to your seals and glass design. Allowing you to build a product to totally suit your individual project



**PSG0101**  
Glass to Wall Lock



**PSG0103**  
Glass to Glass Lock



**PSG0105**  
Shower/toilet door lock



**PSG0103**  
Coat Hook



**PSG0104**  
Adjustable Foot Assembly

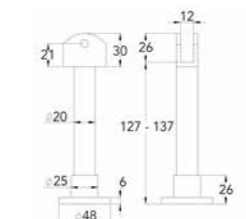
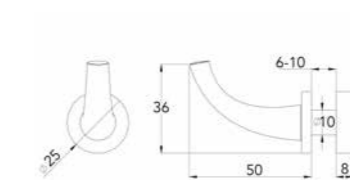





## LEISURE SOLUTIONS TOILET PARTITIONS

Roman have developed urinal partitions in 10mm and 12mm toughened safety glass. The standard products come with an all over etch or frosted finish for privacy. The hinges are extremely durable stainless steel. Whilst the standard options are shown we can clearly design partitions to match any design requirement and also utilise solid surface sheet if required in place of glass.



PSG0126  
Toilet Partition Bracket  
Polished Chrome

PSG0127  
Toilet Partition Bracket  
Brushed Stainless Steel



Digitally printed glass urinal partitions



## GLASS PROTECTION

### The Ultimate Bathroom Protector On Glass

All Roman's Enclosures and Bath Screens are pre-coated with Roman Ultra Care, our own unique glass protection system. We strongly advise that you include Ultra Care in your specification. Pre-coated glass protection systems will always diminish in their effectiveness over time, depending on how often the shower is used and how often it is cleaned. Unlike other systems, Roman Ultra Care in a bottle can be used in tandem with the pre-coat to build up the effectiveness and make it stronger the more you clean.

Roman Ultra Care is an award winning bathroom protector and has a 15 year track record for successfully protecting Roman's extensive product range. When applied to the glass of an enclosure or bath screen it creates a chemical barrier which provides protection against the build-up of grime, limescale and stains. The protective barrier means water glides off the glass with ease. This results in the protected surface remaining easy to clean by simply applying a mild detergent and wiping with a damp cloth or using a Roman Shower Blade.

By topping up the glass protection system with Roman Ultra Care in a bottle every time you clean, you can significantly reduce the amount of time required to clean your enclosure and bathroom surfaces. Most importantly, you can considerably prolong the life of your Roman product and at the same time do your bit for the environment by eliminating the use of harsh and damaging cleaning products.

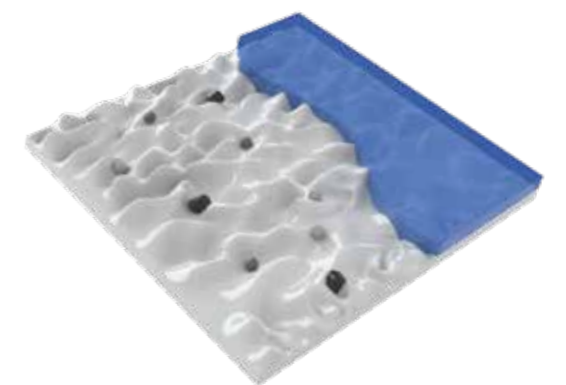

### SIMULATION OF GLASS SURFACE MAGNIFIED

All glass surfaces have a non smooth finish which can attract the build-up of particles. Roman Ultra Care provides an invisible protective film which seamlessly seals the surface to ensure this build-up does not bond to the glass and the glass retains its optical clarity for lasting sparkle

As well as considering the environment during the manufacture of our products, we are also mindful of how our products can impact on the environment after they leave us. The addition of our Ultra Care Pre-coated Glass Protection means that dirt, grime and soap scum are washed away during the shower use. This means the use of harsh chemicals during the cleaning process can be eliminated and less water is required during the cleaning process.



# SOLID SURFACE ANTI-SLIP TRAYS



Our collection of Solid Surface Shower Trays offers a stylish finish, with a domed aluminium waste cover. The low profile trays are self-reinforcing so can be laid directly down to joists and then tiled up to, achieving a level access wetroom look. They are available in matt white or grey which has been approved for Anti-Slip properties. For volume orders we can accommodate a variety of colour finishes and sizes to your specification, including stone effect finishes to coordinate your bathroom design.

### SPECIFICATIONS:

- Ultra low 50mm profile
- Manufactured using Roman Stone solid surface technology
- One angle of slope to waste to maximise flow rating
- Fast flow waste included
- Solid Surface Plinth and Leg Set supplied as standard
- Chrome plated domed waste



Matt White Matt Grey

Standard sizes available (bespoke sizes available for volume orders).

SIZE (MM)	FINISH	WHITE CODE	GREY CODE
1000 x 800	Matt	RST108	RST108MG
1200 x 800	Matt	RST128	RST128MG
1200 x 900	Matt	RST129	RST129MG
1300 x 800	Matt	RST138	RST138MG
1400 x 900	Matt	RST149	RST149MG
1500 x 800	Matt	RST158	RST158MG
1500 x 900	Matt	RST159	RST159MG
1600 x 700	Matt	RST167	RST167MG
1600 x 800	Matt	RST168	RST168MG
1700 x 800	Matt	RST178	RST178MG

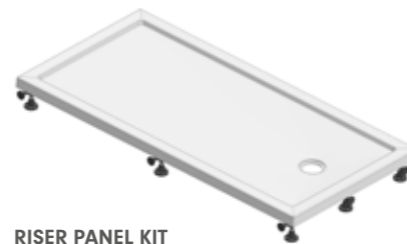

**RISER PANEL KIT**  
Shown with legs and plinth

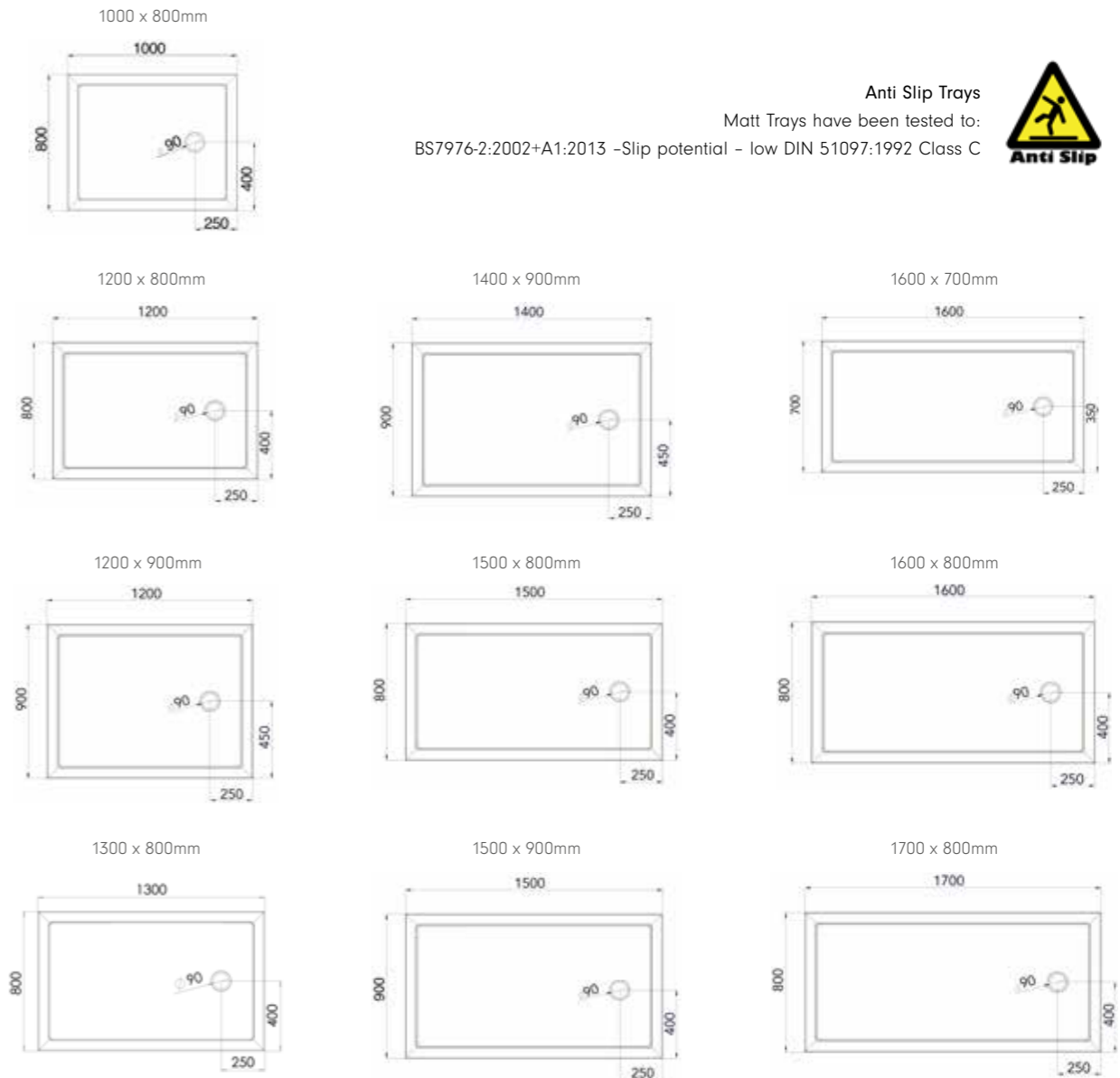
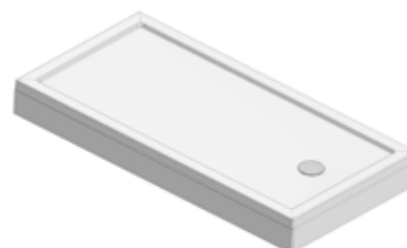

# BUILDING INFORMATION MANAGEMENT (BIM)

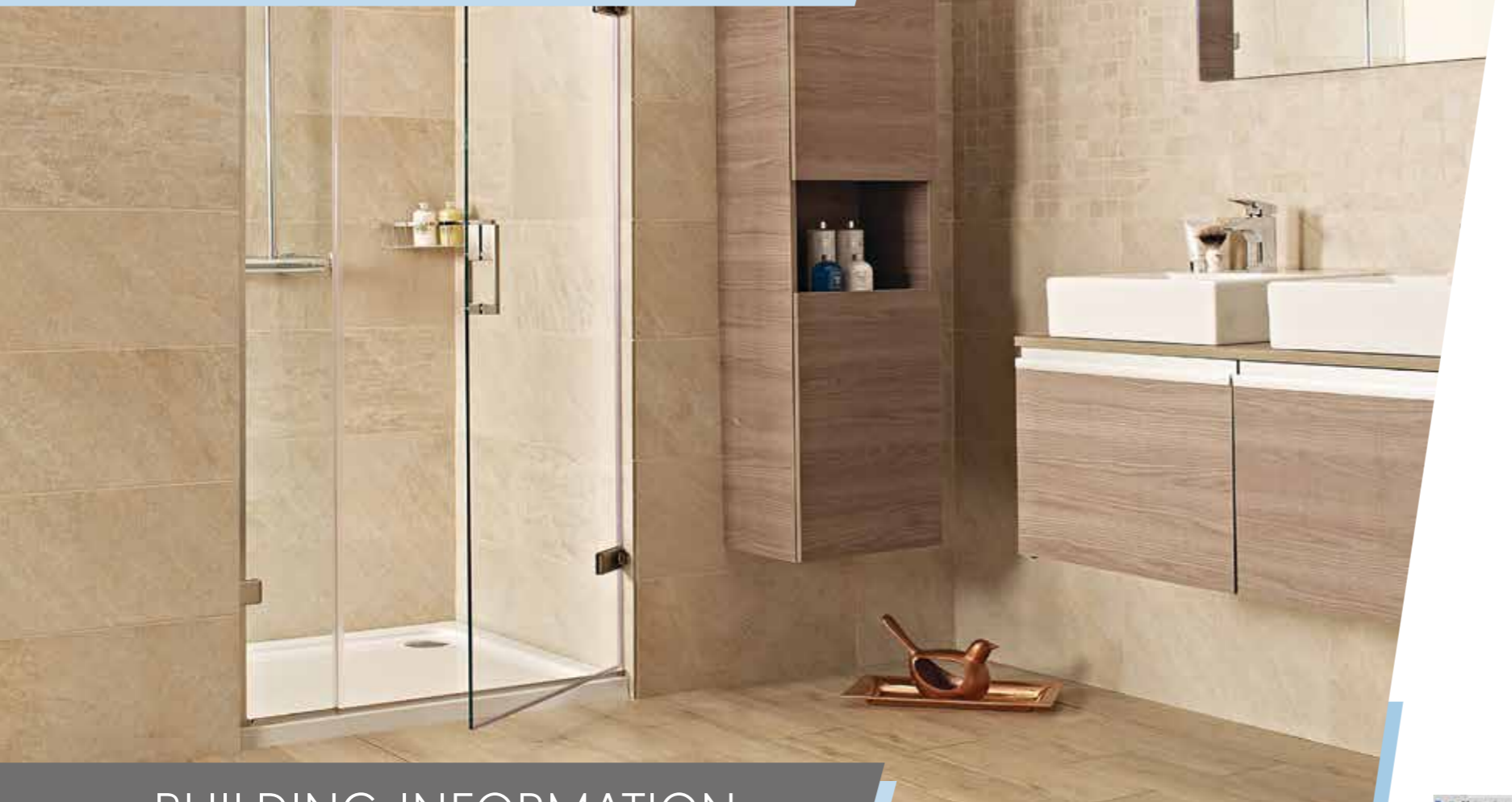

# BUILDING INFORMATION MANAGEMENT (BIM)

## BIM presents a number of advantages such as;

- saving crucial time
- much more accuracy in estimation
- avoidance of error, alterations and rework due to information loss.

Roman has invested in BIM and their key collections of Shower Enclosures, Wetrooms, Walk-in Enclosures and Shower Trays are now available in the BIM format.

Download BIM files now at [www.roman-showers.com](http://www.roman-showers.com)



BIM is an acronym for Building Information Management, or Building Information Modelling.

It is a digital representation of physical and functional characteristics of a facility. BIM creates facilities models within a computer and because they are digital and computer based models of building elements, in Roman's case Shower Enclosures and Shower Trays, they are far more useful than hand or computer drafted drawings.

Coupled with the visual representation of the product very importantly it also gives products their provenance and standards. The provenance being the manufacturer's details, for example, the range, door style, code etc. and very importantly all relevant standards, such as EN standards and CE marking. If the product is substituted for an inferior or non-conformant product in any stage of the design plan this will be highlighted to a client as being non-conformant.

Building Information Modelling describes the development of designing a building collaboratively using one coherent system of computer models rather than as separate sets of drawings.

Roman understand that BIM is on its way to becoming an industry standard and have been early adopters of BIM for their key Shower Enclosure and Shower Tray product ranges. Information is key in the BIM process and is aimed to bring efficiency improvements to the industry.

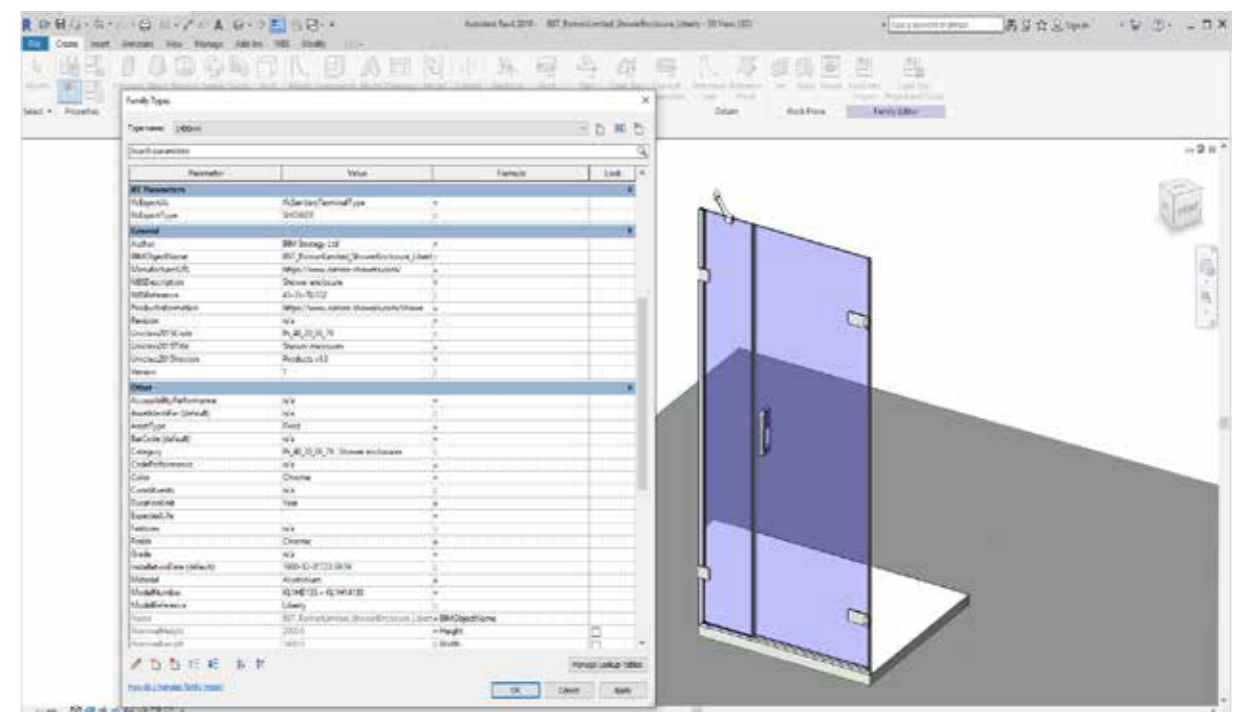



Your requirements created in visual format - example of how your drawings will look:



## HOW TO ORDER YOUR PRODUCT

Ordering your showering solution is simple:

- 1 Select the specific components you require including; glass options, hinges and fixings, handles, wall profiles, seals, bracing systems or tray option.
- 2 Send us the specifications and volumes along with your dimensions (and preferably CAD drawings) by e-mail either to:
  - [ExportProjects@roman-showers.com](mailto:ExportProjects@roman-showers.com) (outside the UK) or
  - [UKprojects@roman-showers.com](mailto:UKprojects@roman-showers.com) (inside the UK)
- 3 We will then send you a CAD line drawing of your design, quote and indicative lead time. For an example of the CAD drawing you will receive, please see the example image on the opposite page.

## CONTACT US

### UNITED KINGDOM

Roman Limited  
Whitworth Avenue  
Aycliffe Business Park  
County Durham  
DL5 6YN  
England, UK  
Tel: +44 (0) 1325 311318

### UK Sales:

Tel: +44 (0) 1325 328034

### UK Email Enquiries:

[orders@roman-showers.com](mailto:orders@roman-showers.com)

### International Sales:

Tel: +44 (0) 1325 327740

### International Email Enquiries:

[international@roman-showers.com](mailto:international@roman-showers.com)

### ASIA PACIFIC

Roman Asia Sdn Bhd (091603-K)  
No.6, Jalan Olivin  
Taman Industri Sungai Purun  
43500 Semenyih, Selangor,  
Malaysia

### Asia Sales:

Tel: +60 (0) 3 8723 1211

### Asia Email Enquiries:

[romanasia@roman-showers.com](mailto:romanasia@roman-showers.com)

### A&D Showroom Asia:

Cosentino Centre Kuala Lumpur  
Jalan TSB 8  
Taman Industri Sungai Buloh  
47000 Petaling Jaya, Selangor  
Malaysia

### ROMAN IRELAND

W10F  
Ladytown Business Park  
Naas  
County Kildare  
Ireland

### Ireland Sales:

Tel: +353 (0) 45 408 118

### Ireland Email Enquiries:

[irelandsales@roman-showers.com](mailto:irelandsales@roman-showers.com)

# HINGES

Manufactured from chrome plated brass, our collection of hinges ensure a high quality finish and smooth opening action.

Our range of hinges include;

- glass to glass options
- glass to wall
- 180° functionality (both inward and outward opening)
- inward opening and outward opening.

All are presented in a variety of shapes and sizes to help you achieve the look you aspire to - many options feature self-closing sprung hinges.



**PSG0001**  
Inward and/or Outward Opening  
Curved Glass to Wall Hinge  
Chrome



**PSG0003**  
Outward Opening only  
Curved Glass to Profile Hinge  
Chrome

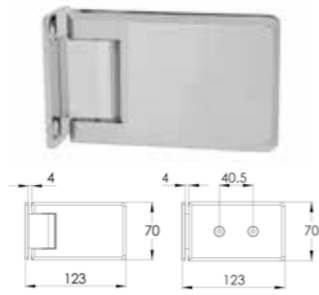

**PSG0004**  
Inward and/or Outward Opening  
Square Glass to Wall Hinge  
Chrome

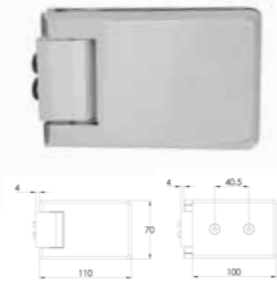

**PSG0006**  
Outward Opening only  
Square Glass to Profile Hinge  
Chrome



**PSG0125**  
Adjustable Outward Opening  
Square Bath Hinge  
Chrome

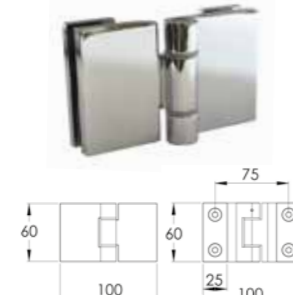

**PSG0010**  
Outward Opening to  
90° Bath Screen Hinge  
Chrome

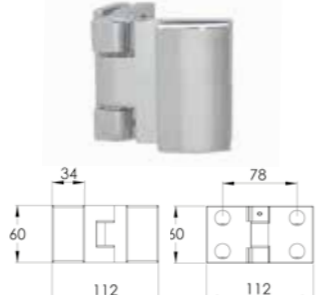

**PSG0009**  
Inward Opening Bath Screen Hinge  
Chrome



**PSG0141**  
Bath Screen Hinge  
Chrome • Black

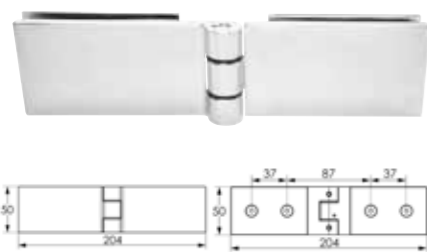

**PSG0139**  
Outward Opening Hinge  
Chrome



**PSG0148**  
Hydraulic Soft Close Hinge  
Various Colours Available



**PSG0149**  
Hydraulic Glass to Glass Hinge  
Various Colours Available

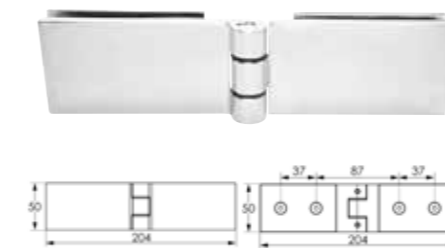

**PSG0140**  
90° Outward Opening Hinge  
Chrome • Black



**PSG0011**  
Inward and Outward Opening  
Square Glass to Wall Hinge  
Chrome • Brushed Nickel • Polished Nickel  
Brushed Brass • Matt Black

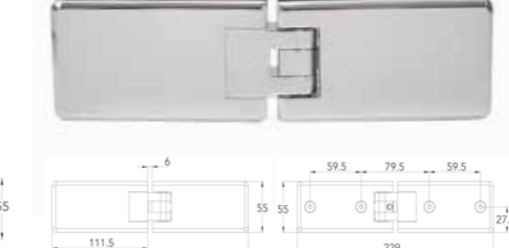

**PSG0012**  
Adjustable inward and Outward Opening  
Square Glass to Glass Hinge  
Chrome • Brushed Nickel • Polished Nickel  
Brushed Brass • Matt Black

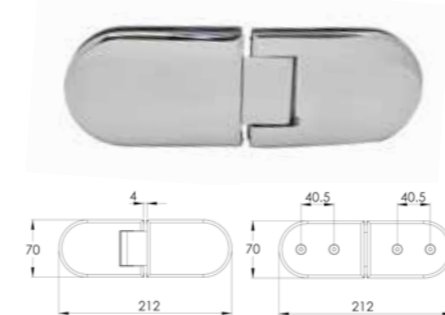

**PSG0002**  
Inward and/or Outward Opening  
Curved Glass to Glass Hinge  
Chrome

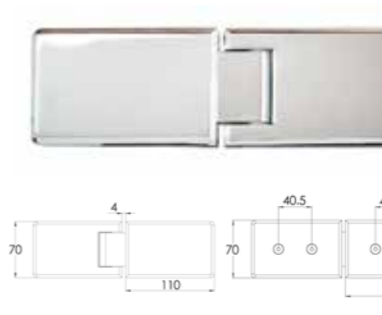

**PSG0005**  
Inward and/or Outward Opening  
Square Glass to Glass Hinge  
Chrome

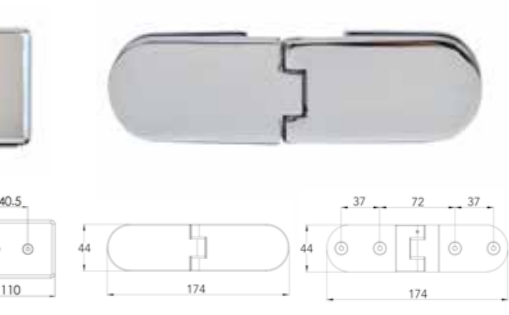

**PSG0013**  
Outward Opening to 90° Hinge  
Chrome

## Standard Stocked Colours

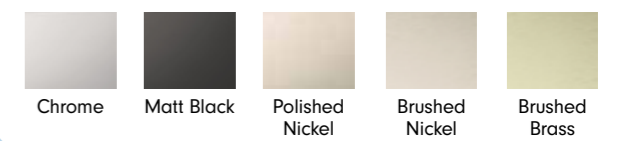

We offer hinges in a chrome, matt black, brushed nickel, polished nickel and brushed brass finish. If the hinge style and finish you are looking for is not pictured here, please contact us with your requirements as this is only a small sample of what we have available.

# BRACKET FIXINGS

Our bracket fixings are manufactured from high quality chrome plated brass, ensuring quality right down to the finer details. These are finished in; chrome, brushed nickel, polished nickel, brushed brass or matt black, but for volume orders we can accommodate any colour you would like.

If the fixing style and finish you are looking for is not pictured here, please contact us with your requirements as this is only a small sample of what we have available.

## Standard Stocked Colours

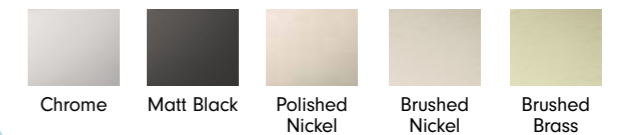

**PSG0014**  
90° Square Glass to Wall Bracket  
Chrome



**PSG0015**  
90° Square Glass to Glass Corner Bracket  
Chrome



**PSG0016**  
135° Square Glass to Glass  
Neo-Angle Bracket  
Chrome

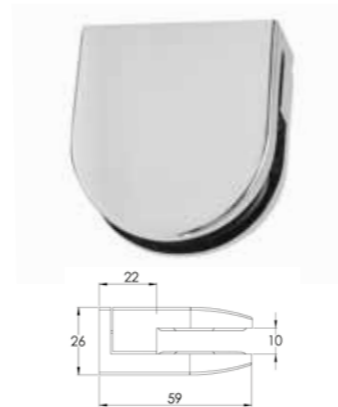

**PSG0023**  
Curved Ceiling Bracket  
Chrome



**PSG0022**  
Square Ceiling Bracket  
Chrome • Brushed Nickel • Polished Nickel  
Brushed Brass • Matt Black



**PSG0142**  
Wall Bracket  
Chrome • Brushed Nickel • Polished Nickel  
Brushed Brass • Matt Black



**PSG0017**  
90° Curved Glass to Wall  
Corner Bracket  
Chrome

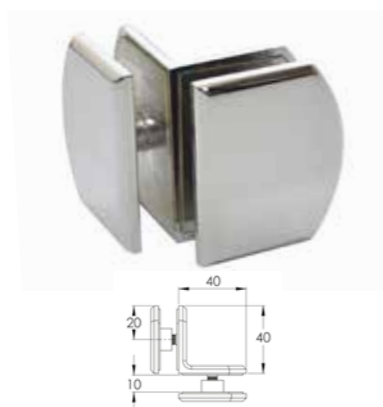

**PSG0018**  
90° Curved Glass to Glass  
Corner Bracket  
Chrome



**PSG0019**  
135° Curved Neo-Angle  
Glass to Glass Bracket  
Chrome

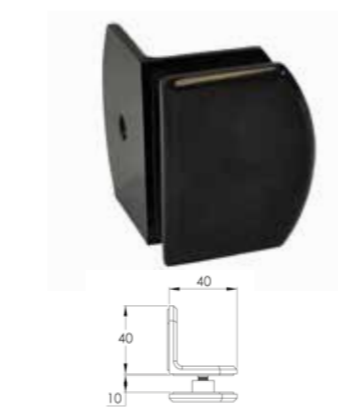

**PSG0020**  
90° Curved Glass to Wall  
Corner Bracket  
Matt Black

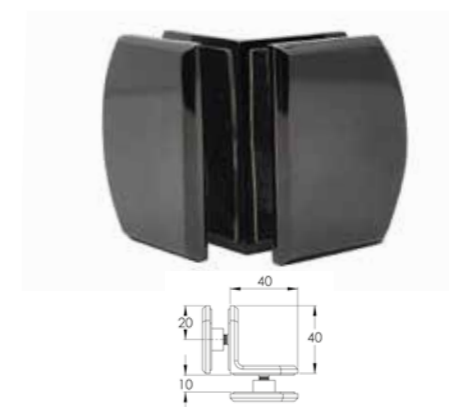

**PSG0021**  
90° Curved Glass to Glass  
Corner Bracket  
Matt Black



**PSG0024**  
Square Double Enclosure  
Partition Bracket  
Chrome

# HANDLE OPTIONS

Whether you would like a "statement" handle or are looking for something a bit simpler, with our range you can pick something to perfectly complement your specification. For a totally minimalist look, we can even completely eliminate the handle and leave a designer hole in the glass as an alternative. Our handle range also includes options that double up as a towel rail - perennially popular in the Hotel sector.

Our selection of handles are manufactured from high quality chrome plated brass and are finished in chrome, brushed brass, brushed or polished nickel, or matt black. If the style and finish you are looking for is not pictured here, please contact us with your requirements as this is only a small sample of what we have.

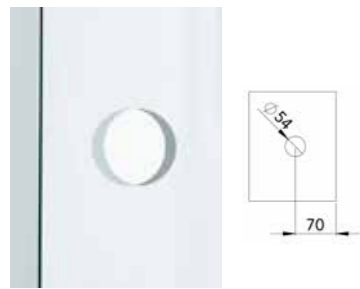

**PSG0041**  
Finger Pull in Glass

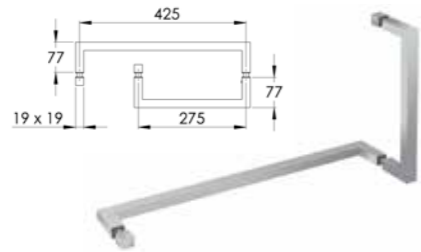

**PSG0034**  
Square Towel Rail Handle  
19 x 275 x 425mm  
Chrome

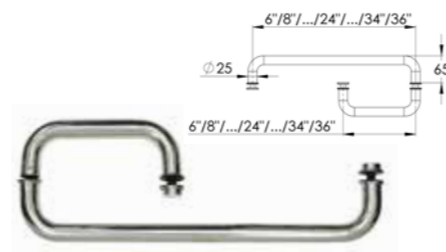

**PSG0038**  
TRound Towel Rail Handle  
25 Dia Sizes Available: 6"/8"...24"/34"/36"  
Chrome

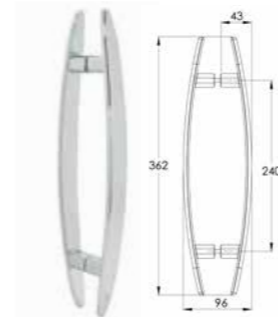

**PSG0025**  
Large Designer Handle  
240mm centres  
Chrome



**PSG0031**  
Large Square Handle  
240mm centres  
Chrome

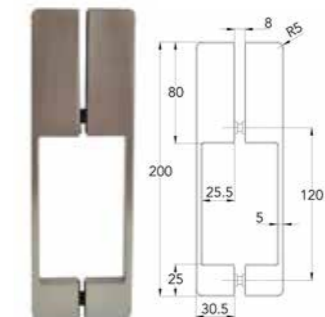

**PSG0093**  
Medium Designer Handle  
Chrome • Brushed Nickel • Polished Nickel  
Brushed Brass • Matt Black

**Standard Stocked Colours**

Chrome	Matt Black
Polished Nickel	Brushed Nickel
Brushed Brass	

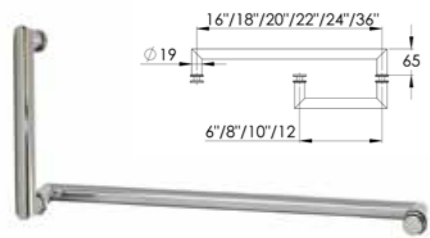

**PSG0040**  
Square Towel Rail Handle  
25 Dia Sizes Available: 16"/18"/20"/22"/24"/36"  
Chrome

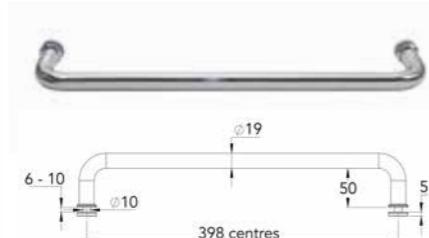

**PSG0106**  
Towel Rail Handle  
19 Dia  
Chrome

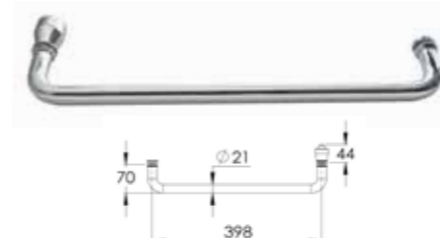

**PSG0128**  
Towel Rail Handle with Rubber Stop  
19 Dia  
Chrome • Matt Black

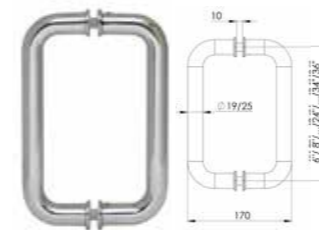

**PSG0036**  
Round D Handle (Note Size options)  
19 or 25mm Dia / 220/240mm centres  
Chrome

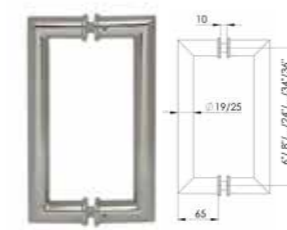

**PSG0039**  
Square Handle  
25 Dia / 8" centres (Note Size options)  
Chrome

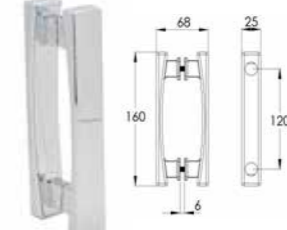

**PSG0032**  
Medium Square Handle  
120mm centres  
Chrome

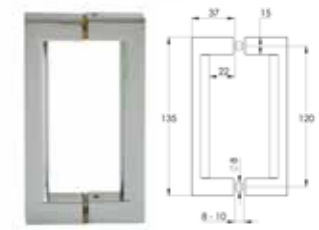

**PSG0116**  
Small Square Handle  
Chrome



**PSG0035**  
Pull Handle - Single Hole Fix  
Chrome



**PSG0095**  
Minimal Pull  
Chrome

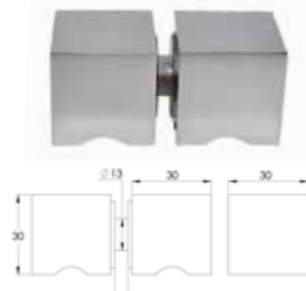

**PSG0115**  
Square Pull Handle  
Chrome

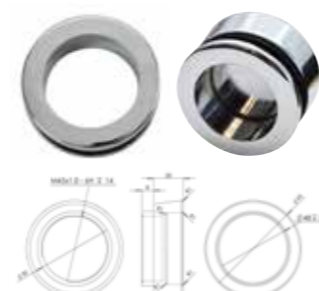

**PSG0094**  
Finger Pull Handle Cover Assembly  
Chrome



**PSG0145**  
Handle  
Various Colours Available



**PSG0033**  
Square D Handle  
19 Dia / 275mm centres  
Chrome

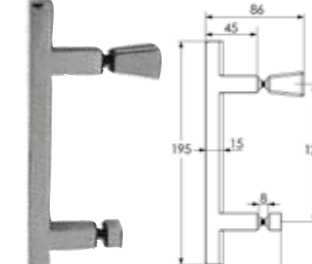

**PSG0143**  
Innov8 Handle  
Chrome • Matt Black

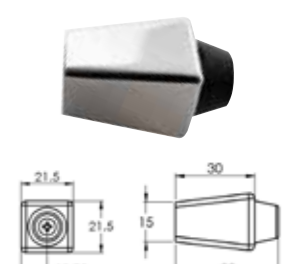

**PSG0144**  
Pull Handle - Single Hole Fix  
Chrome

# ALUMINIUM WALL PROFILES



**PSG0042**

Decem Alcove Door Hinge System 1950mm

Vertical Decem profiles are available up to 2.7 metres high as standard

If you are looking for a totally minimalist finish, or alternatively would like a quick and straight forward installation, then the wall profile you can pick can be crucial. We offer a variety of profiling systems; from angled profiles, for angled glass; through to profiles that can be channelled into the wall so only the glass is visible. Our Wall Profile System offer options to suit a variety of door styles including, hinged and sliding doors, along with wetroom panels. We always recommend the use of our discreet profiling to enhance performance and offer on-site adjustment.

If the component and finish you are looking for is not pictured here, please contact us with your requirements as this is only a small sample of what we have available.

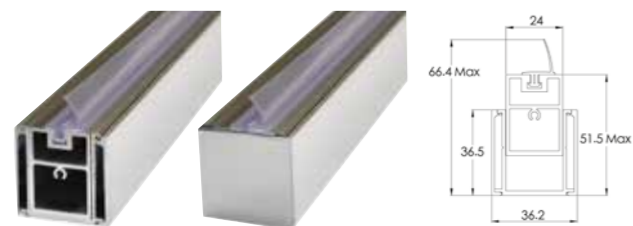

**PSG0043**

Decem Hinged Alcove Seal System  
Cover cap supplied

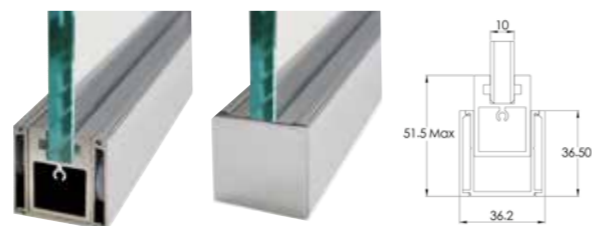

**PSG0047**

Decem Glass Panel Wall Profile System  
Cover cap supplied

## SILICONE FREE WALL FIXING

**A unique silicone free wall profile sealing tape system**

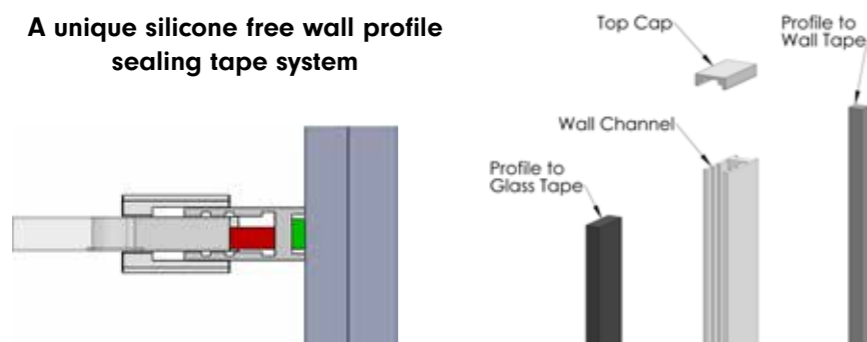

**PSG0098**

Liberty Silicone Free Profile System 8/10mm  
Chrome • Brushed Nickel • Polished Nickel  
Brushed Brass • Matt Black

### Standard Stocked Colours

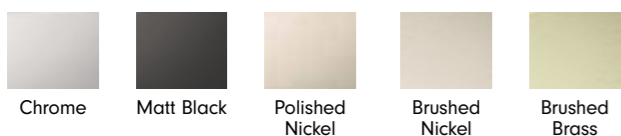

A unique wall profile sealing tape system technology, to increase water integrity, whilst also keeping with the minimalist design. A sealant filled tape is fitted inside the wall profile and is activated before it is joined to the wall and this eliminates the need for any vertical or visible silicone.

## FACE FIX SYSTEM

A unique design solution for installation without two facing walls.

**AVAILABLE IN 4 RANGES**

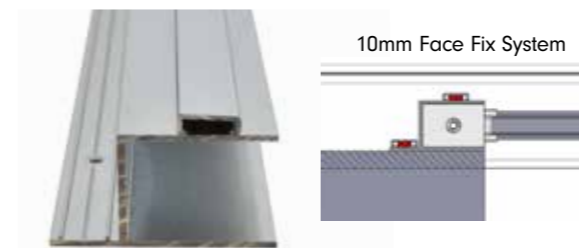
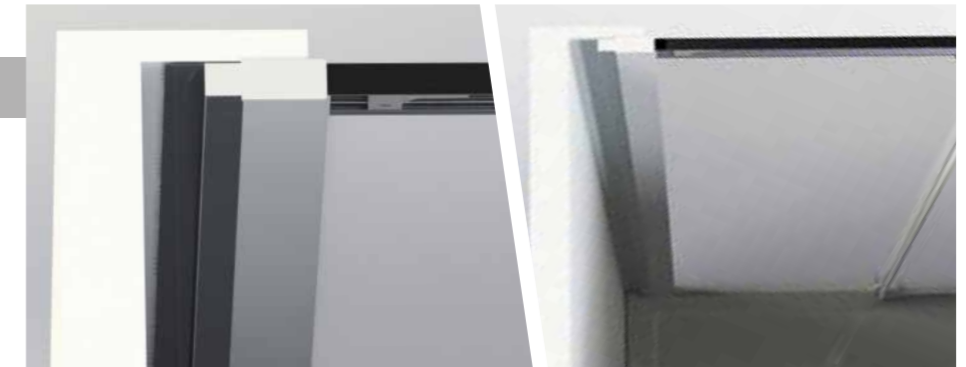

**PSG0136**

10mm Face Fix Wall Profile  
Cover Cap supplied

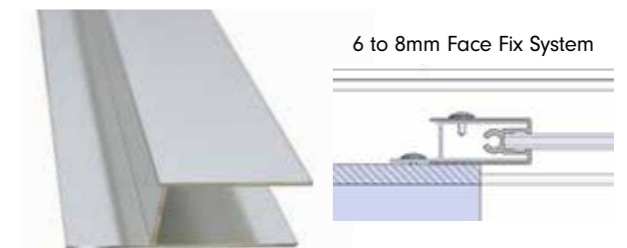

**PSG0135**

8mm Face Fix Wall Profile  
Cover Cap supplied

## ALUMINIUM PROFILE SYSTEMS ILLUSTRATED WITH AND WITHOUT STAINLESS STEEL END CAPS



**PSG0047**

10mm Exposed Glass Wall Channel  
Cover Cap supplied  
Chrome • Black



**PSG0090**

8mm Exposed Glass Wall Channel  
Cover Cap supplied  
Chrome • Black

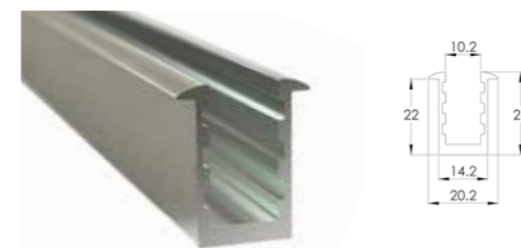

**PSG0048**

10mm Concealed Glass Wall Channel



**PSG0096**

8mm Concealed Glass Wall Channel



**PSG0050**

Bottom Door Sealing Strip



**PSG0049**

Concealed Glass Floor Channel



# ROUND BRACING SYSTEMS

Our selection of Bracing Systems allow you to keep your Shower Enclosure, Bath Screen or Wetroom Panel sturdy, with a look and overall finish that suits your space. We provide the bracing bars to your exact sizing specification, and these can be trimmed to size on site (standard sizes are illustrated).

The bracing bar systems are all manufactured using chromed brass. Largely we supply these with a chrome finish, but if you would like a specific colour we are able to accommodate this for volume projects.

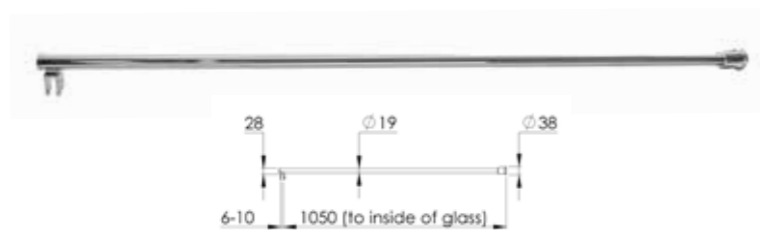

**PSG0134**  
Back to Wall Bracing Kit  
Chrome



**PSG0054**  
Ceiling Bracing  
Chrome



**PSG0055**  
Brace Bar Wall Joint  
Chrome

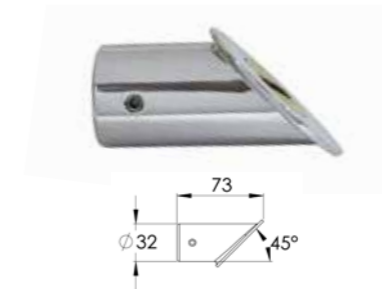

**PSG0056**  
135° Brace Bar Wall Joint  
Chrome

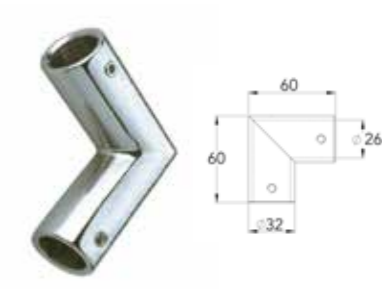

**PSG0057**  
Brace Bar 90° Joint  
Chrome

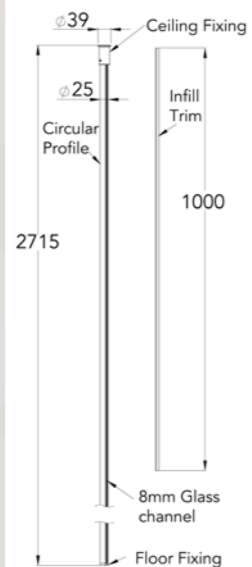

**PSG0053**  
Floor to Ceiling Brace - Round  
Chrome

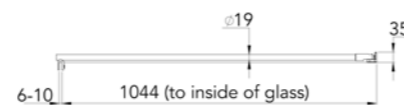

**PSG0052**  
Low Level Back to Wall Bracing  
can be cut to 45° angle for corner use  
Chrome



**PSG0058**  
Neo Angle 135° Bracing Bracket  
Chrome



**PSG0059**  
Bracing Tube (Standard sizes up to 2m)  
Chrome



**PSG0060**  
Brace Support  
Chrome



**PSG0061**  
Wetroom Panel Support Foot  
Chrome



**PSG0113**  
Brace Bar T-Joint  
Chrome



**PSG0114**  
Brace Bar Joint  
Chrome

# SQUARE BRACING SYSTEMS

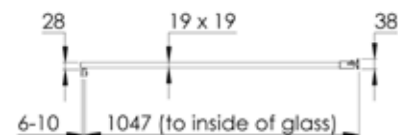

**PSG0130**  
Back to Wall Bracing Kit - Square  
Chrome • Matt Black

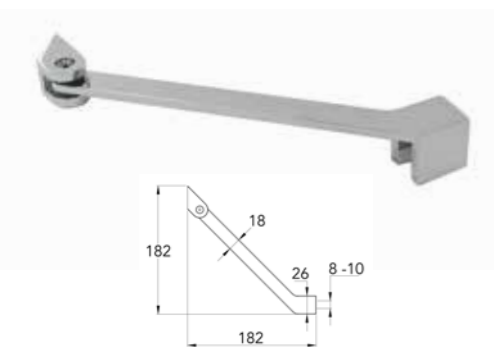

**PSG0100**  
LH Brace Bar Assembly  
Chrome • Brushed Nickel • Polished Nickel  
Brushed Brass • Matt Black



**PSG0099**  
RH Brace Bar Assembly  
Chrome • Brushed Nickel • Polished Nickel  
Brushed Brass • Matt Black

### Standard Stocked Colours



**PSG0132**  
Ceiling Bracing Kit - Square  
Chrome • Matt Black

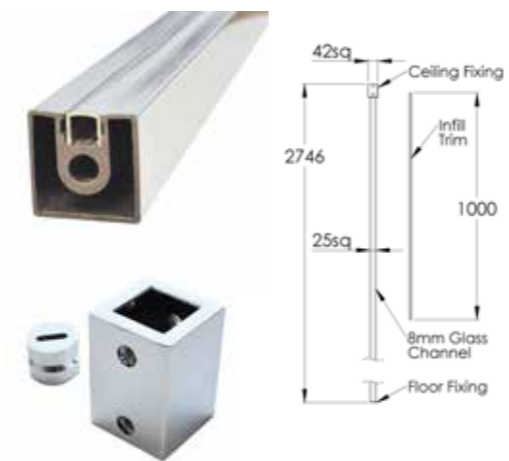

**PSG0133**  
Floor to Ceiling Bracing Kit - Square  
Chrome • Matt Black

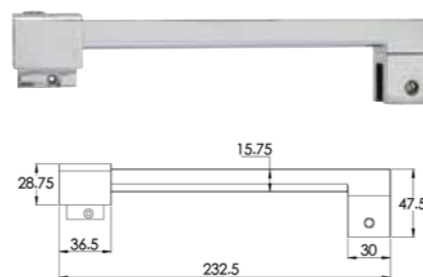

**PSG0091**  
Decem Brace Bar  
Chrome



**PSG0131**  
T Bracing Kit - Square  
Chrome • Matt Black



# SLIDING DOOR SYSTEMS

Our Sliding Door Systems allow you to create the look you seek, with a smooth action door that glides with ease with a "soft close" style sprung stop. The components are manufactured from chromed brass and are available in a chrome finish.

If the Sliding Door System style and finish you are looking for is not pictured here, please contact us with your requirements as this is only a small sample of what we have available.



**PSG0137**  
LH Level Access Bottom Guide  
Chrome

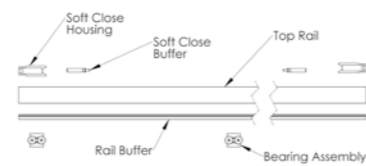

**PSG0107**  
Luxury Sliding Door System  
Chrome



**PSG0138**  
RH Level Access Bottom Guide  
Chrome

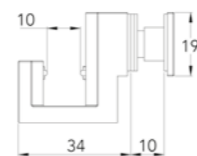
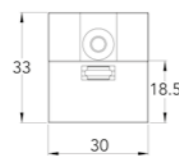

**PSG0108**  
Bottom Guide Assembly  
Chrome



We have incorporated soft close pistons into a large number of our sliding door systems. These either softly cushion a heavy door when closing or carefully guide a sliding door into its open or closed position.





## SEALING SYSTEMS

We offer a range of Sealing Systems to suit whatever enclosure style you choose. We will recommend which seal is compatible with your chosen product type, whether it is a hinged door or sliding door configuration that you choose. The more popular options are showcased in this section - many other options are available as required. Our Water Safe System (pictured) allows frameless Enclosures to offer water integrity that has traditionally only been offered by standard Enclosures with no caveats regarding water pressure or direction.

## WATER SAFE SYSTEM

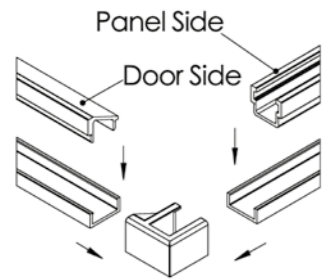

Whilst many of our products are giving a truly minimal look and feel, there is no need to compromise on the water integrity. The discreetly designed water safe system slots beautifully into profiles and is rigidly held together with mouldings. This then offers a minimalistic look with the reassurance of total water integrity.

**Standard Stocked Colours**

				
Chrome	Matt Black	Polished Nickel	Brushed Nickel	Brushed Brass

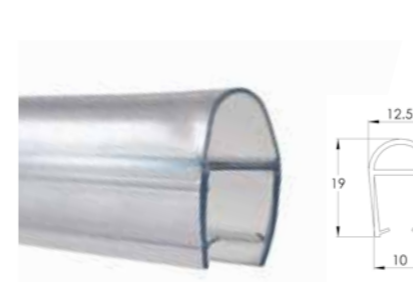
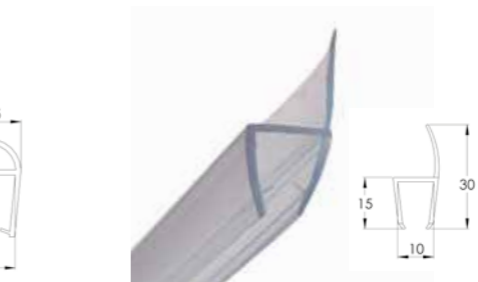
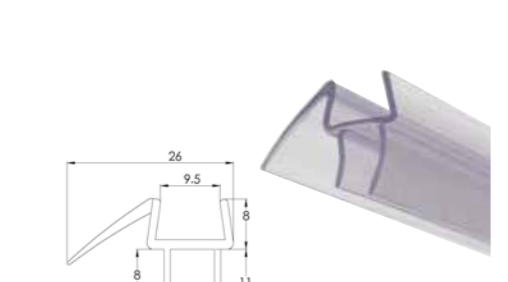
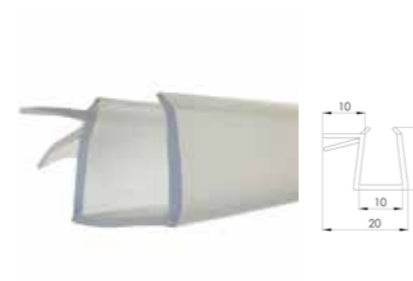
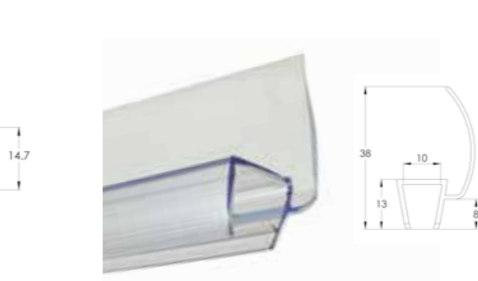
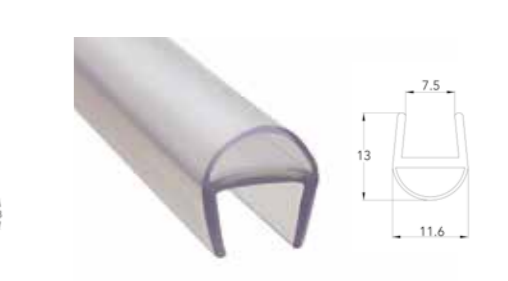
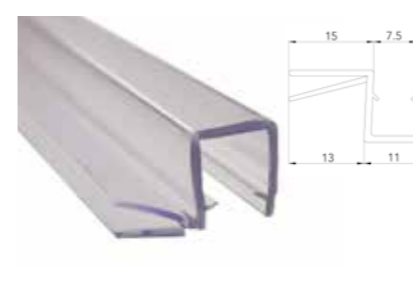
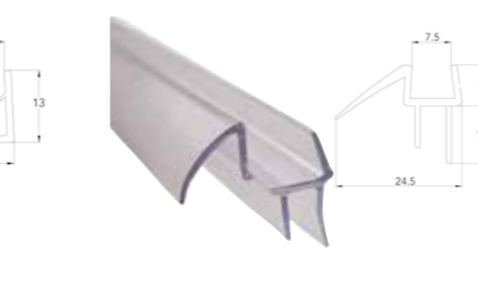
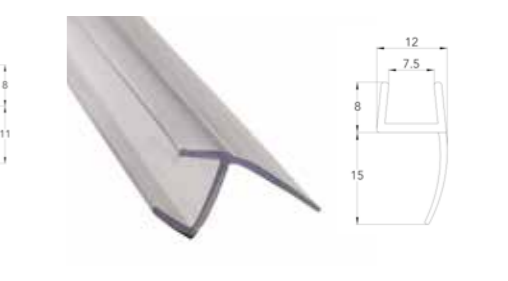
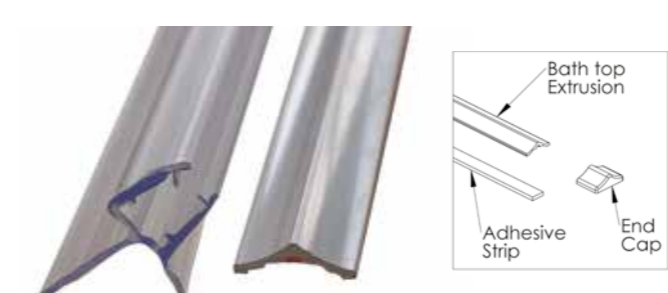
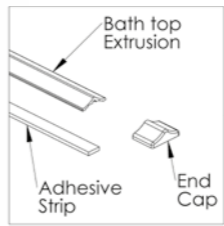
 <p><b>PSG0065</b> Vertical Bubble Seal</p>	 <p><b>PSG0066</b> 180° Seal</p>	 <p><b>PSG0067</b> Deflector Seal</p>	
 <p><b>PSG0068</b> 90° Seal</p>	 <p><b>PSG0069</b> Vertical Seal inc cut out</p>	 <p><b>PSG0109</b> 8mm 90° degree seal</p>	
 <p><b>PSG0110</b> 8mm 90° degree seal</p>	 <p><b>PSG0111</b> 8mm Deflector Seal - 1000mm</p>	 <p><b>PSG0112</b> 8mm 180° degree seal</p>	
 <p><b>PSG0097</b> 8mm 90° degree seal</p>			

Magnetic seals available for folding bath screens  
**All seals available in Ultra Clear option.**

# ACCESSORIES

A stylish and dramatic collection of branded accessories to give the finishing touch to the bathroom, as well as ensuring accessibility with the addition of grab rails where required.

The accessories are easy fit and carry a 10 year guarantee. All accessories are manufactured from Solid Brass and feature a chrome finish as standard. Selected products are available in a chrome or matt black finish. Please contact us for all your project requirements if the finish you desire is not available.



**PSG0080**  
Large Curved Corner Basket  
Chrome • Matt Black



**PSG0082**  
L Shaped Corner Basket  
Chrome

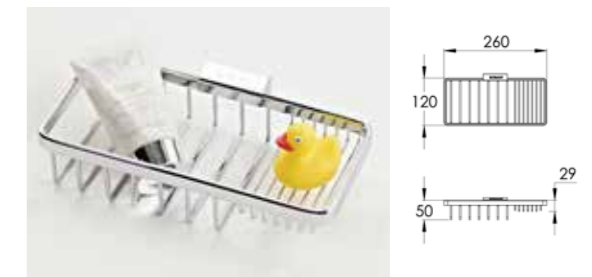

**PSG0081**  
Stepped Soap Basket  
Chrome

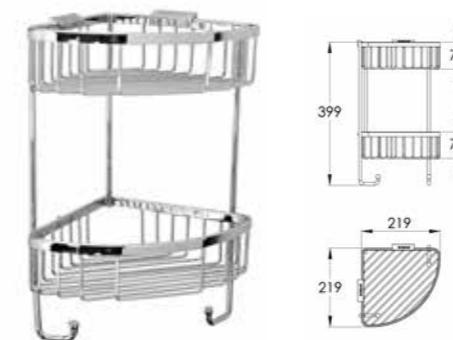

**PSG0083**  
Double Corner Basket  
Chrome • Matt Black



**PSG0084**  
Large Rectangular Basket  
Chrome

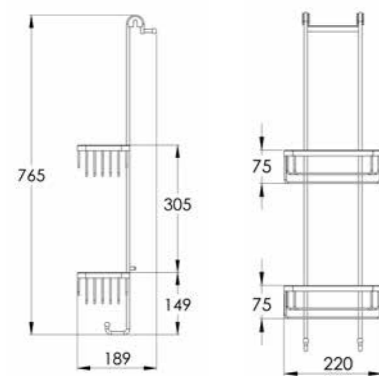

**PSG0079**  
Double Hanging Shower Basket  
Chrome • Matt Black



**PSG0085**  
Double Single Wall Basket  
Chrome • Matt Black



**PSG0088**  
90mm Shower Waste



**PSG0117**  
Designer Corner Basket  
Chrome



## GUARANTEE

Roman Ltd. guarantees all Shower Enclosures and Bath Screens against faulty materials or manufacture for LIFE, provided they have been installed, used and maintained in accordance with our instructions.

All Roman product guarantees must be completed and returned within 60 days of purchase to validate the relevant guarantee. Failure to meet this deadline will result in a statutory 1 year guarantee on all products.

Should a claim arise, Roman Ltd. Customer Relations will investigate the issue. As part of this investigation we request that the following conditions be satisfied:

1. Proof of purchase at the time of the claim.
2. The guarantee applies to the original purchaser only and is non transferable.
3. The product has been fitted/installed in accordance with Roman Ltd. fixing instructions, local bylaws and general good plumbing practice
4. The product has been maintained and cared for in accordance with our instructions (including regular and appropriate cleaning).

If in our opinion the product has been modified, misused, neglected, wilfully or accidentally damaged, we can accept no responsibility for failure.

Roman Ltd. or its representatives must be given the opportunity to inspect the product in the installed condition.

We make every effort to ensure that your product reaches you in perfect condition. However, please be advised that all toughened glass panels are not covered by our guarantee once installation/assembly has commenced. Roman's toughened glass is physically and thermally stronger than standard glass. However any significant impact may cause the glass to shatter in as safe a manner as possible and in accordance with the British and European standard (BS EN14428).

If the product is damaged or not performing as it should, we advise that you cease using the enclosure immediately and seek advice from your installer or Roman Customer Services.

Should any products included in the Lifetime guarantee be used for Commercial use i.e. leisure clubs, schools, hospitals, student accommodation, hotels or residential homes, only a 5 year guarantee will be applicable.

**Roman Ltd**  
Whitworth Avenue, Aycliffe Business Park, County Durham, DL5 6YN | Tel: 01325 311318 | Fax: 01325 319889  
www.roman-showers.com

If in our opinion the product fails due to faulty materials or manufacture and that the conditions above have been met, Roman Ltd. will arrange for a specialist Roman Technical Sales Representative to repair or replace that item at our option.

Roman Ltd. believes in continuous improvement. If in our opinion the product has failed under the terms of the Guarantee and a replacement is offered but identical goods are no longer available, Roman Ltd. will replace it with our nearest equivalent product. For countries outside of the UK and Republic of Ireland, where a product has failed due to faulty materials or manufacture, a replacement product or product part will be offered only.

Should Roman Ltd. carry out work as a result of a claim but subsequently it is revealed that the product has been abused or improperly installed, we reserve the right to charge the customer for the expense incurred.

The liability of Roman Ltd. is limited to the product supplied by Roman Ltd. and does not extend to consequential loss or damage arising from the defective product.

This Guarantee, which is effective for products purchased after February 1st 2006, states our entire liability and is offered to customers acquiring our products as consumers, not in the course of trade or business. Ex displays or products reinstalled from their original position are not covered under this guarantee.

Non glass or metallic parts (e.g. seals) are subject to normal wear and tear through usage and are therefore covered on all products for 1 year from installation.

Roman Ultra Care pre-coat is not covered by this guarantee and it must be maintained by applying Ultra Care from a bottle on an ongoing basis.

Roman products not included in the lifetime guarantee include Roman Stone Shower Trays, Roman Accessories and Roman Shield® tanking products which are covered for 10 years. Roman Acrylic Capped Trays are covered for one year. Commercial projects with specific guarantee requirements can be subject to negotiation and agreement on a project by project basis. Any such agreements must be confirmed in writing prior to product supply or commencement in project works.

This guarantee does not affect your statutory rights.

This guarantee is wholly applicable in the U.K. and Republic of Ireland - export conditions as indicated

## IMPORTANT PRODUCT DETAILS

- Enclosures and screens carry a Lifetime manufacturer's guarantee if products are installed according to the installation instructions - see guarantee criteria to the Left.
- Simple and clear installation instructions are included with all Roman Products.
- Roman products are available for Virtual Worlds design service. For more information contact Roman Customer Relations on 01325 328033.
- Any guarantee variations are indicated separately.
- All guarantee forms supplied with installation instructions must be completed and returned to Roman within 60 days to validate the lifetime guarantee otherwise only a statutory 12 month guarantee will apply.
- All Roman Bath Screens and Enclosures are manufactured using toughened safety glass which complies to BSEN12150.
- All Roman Bath Screens and Enclosures are tested in accordance with BSEN14428 - shower enclosures, functional requirements and test methods.
- Roman's toughened glass is completely safe for use in our shower enclosures and bath screens; providing our products are installed according to our guidelines.
- It is important to note, that the glass must not be mounted or 'pinched' in such a way that would cause a stress point to develop in the glass. In addition, it must not be subjected to any sharp impact or severe temperature fluctuation which may also cause a stress point to develop in the glass.
- Roman's toughened glass is physically and thermally significantly stronger than standard glass. However a significant impact (or stress as outlined above) can cause toughened glass to break. In the event of breakage, toughened glass will break safely into small fragments in line with all relevant standards.
- All heights quoted for enclosures and bath screens are from the top of the shower tray or bath.
- All fixings are hidden on Roman products.
- The term "Silver" and "Nickel" describes the colour of the aluminium finish. No silver metal is included in any Roman products.
- All fixings and pivot pins are manufactured from stainless steel - this adds great strength and durability to Roman products.
- All seals and gaskets on Roman products are manufactured from colourless PVC.
- Roman over-bath products are not designed for baths with shaped or stepped fronts or integral soap dishes.
- The design rights of these products are owned by Roman Limited. All rights reserved.
- For compatibility of Roman enclosures with steam generators please contact Roman Customer Relations for advice on 01325 328033.
- Where indicated that products are suitable for use with steam generators, this refers to the performance of the product components. We do not however suggest that the product will have complete steam integrity.
- Due to the nature of wetroom panel products, water integrity cannot be guaranteed. Please consult your installer.
- We make every effort to ensure that your product reaches you in perfect condition. However, please be advised that all toughened glass panels are not covered by our guarantee if installed incorrectly or are subject to misuse. Roman's toughened glass is physically and thermally stronger than standard glass. However any significant impact may cause the glass to shatter in as safe a manner as possible and in accordance with the British and European standard (BS EN14428).



## CE MARKING



Roman shower enclosures have been tested and fully conform to the scope and relevant characteristics of BS EN14428:2015 (Shower Enclosures - Functional requirements and test methods), to meet the requirements of the mandate given under the EU Construction Product Directive (89/106/EEC).

As a result of full compliance to the directive and harmonized standard; Roman shower enclosures carry the 'CE' mark and are accompanied by a declaration of performance. (Available to view on [www.roman-showers.com](http://www.roman-showers.com))

The CE marking indicates Roman shower enclosures conform to all essential requirements of European health and safety and environmental protection legislation. The conformity is mandatory, and allows Roman products to be legally placed on the market anywhere in the European Economic Area.

Additionally all Roman trays fully conform to EN14527:2016.

**UK (HEAD OFFICE):**

---

Roman Limited,  
Whitworth Avenue,  
Aycliffe Business Park,  
County Durham,  
DL5 6YN,  
England, UK.

**GENERAL RECEPTION:**

Phone: +44 (0) 1325 311318

**UK CUSTOMER RELATIONS:**

Phone: +44 (0) 1325 328033

Email: [custserv@roman-showers.com](mailto:custserv@roman-showers.com)

**UK SALES:**

Phone: +44 (0) 1325 328034

Email: [orders@roman-showers.com](mailto:orders@roman-showers.com)

**INTERNATIONAL SALES/CUSTOMER RELATIONS:**

Phone: +44 (0) 1325 327740

Email: [international@roman-showers.com](mailto:international@roman-showers.com)

[www.roman-showers.com/international](http://www.roman-showers.com/international)

**ASIA PACIFIC:**

---

Roman Asia Sdn Bhd <sup>(091603-K)</sup>

No.6, Jalan Olivin, Taman Industri Sungai Purun,  
43500 Semenyih, Selangor, Malaysia.

**ASIA SALES:**

Phone: +60 (0) 3 8723 1211

Email: [romanasia@roman-showers.com](mailto:romanasia@roman-showers.com)

[www.roman-showers.com/international/roman-asia/](http://www.roman-showers.com/international/roman-asia/)

**A&D SHOWROOM ASIA:**

---

Cosentino Centre Kuala Lumpur - Malaysia,  
Jalan TSB 8, Taman Industri Sungai Buloh,  
47000 Petaling Jaya, Selangor, Malaysia.

**ROMAN IRELAND:**

---

W10F

Ladytown Business Park

Naas

County Kildare

Ireland

**IRELAND SALES:**

Phone: +353 (0) 45 408 118

Email: [irelandsales@roman-showers.com](mailto:irelandsales@roman-showers.com)

[www.roman-showers.com/international/roman-ireland-information/](http://www.roman-showers.com/international/roman-ireland-information/)

[www.roman-showers.com](http://www.roman-showers.com)

